

**PHOENIX REGIONAL
STANDARD OPERATING PROCEDURES**

CUSTOMER SERVICE MANAGEMENT

M.P. 201.00

10/15-R

06/20-SR

The Central Arizona Life Safety System Response Council (CALSSRC), Automatic Aid System is a consortium of governments (Cities, Towns, and Fire Districts) joined by an intergovernmental agreement upon which the participants agree to operationally act as one-entity for the purpose of improved fire/rescue/emergency medical services. Together we respond to hundreds-of-thousands of calls for service each year, some calls may seem routine to us, but for the person who called, it is not routine. As professionals we will provide excellent customer service on each and every call, to each and every customer.

CALSSRC defines the customer as, any person who receives our services and anyone with who our members have dealings. Examples of this definition include:

- The actual service recipient
- Anyone who knows or is closely related to the service recipient (e.g., family, friends, neighbors, etc.)
- The people we encounter, directly and indirectly during our workday (e.g., members of organizations we routinely do business with, people who visit our workplace, people who see us during our workday, and people who see us on the road)
- The members of our organization including support staff (our customer services begin with how we treat each other)

These customers are an integral part of our workday. We will treat them in a positive way and include them in our plan to execute excellent customer service. Every interaction with our customers is an opportunity to solve their problem and leave a positive, lasting impression.

PROCEDURE

Our mission and number one priority is to deliver the best customer service possible. Our members are responsible for the following as it relates to customer service:

1. Treat all customers with respect, kindness, patience and consideration. We will respond quickly, skillfully, and positively to every customer.
2. Deal with the customer's situation as an urgent event, from the time we know about it until it is over.
3. Identify and act on opportunities for added value. Added value occurs when we go beyond our standard quick, effective, professional, customer service to create a feeling that the customer was the most important person we served all day. Added value only requires a little extra effort and leaves our customer with the opinion that we care.
4. Provide exceptional customer service, whenever possible. CALSSRC delegates official authority and trusts its members with the power to provide customer service to the level of their abilities and imagination. A members evaluation as to whether or not they are empowered to provide exceptional customer service is determined by:
 - a. Is it the right thing for the customer?
 - b. Is it the right thing for the department?
 - c. Is it legal, ethical, and nice?

**PHOENIX REGIONAL
STANDARD OPERATING PROCEDURES**

CUSTOMER SERVICE MANAGEMENT

M.P. 201.00

10/15-R

06/20-SR

- d. Is it safe?
- e. Is it on your organizational level?
- f. Is it something you are willing to be accountable for?
- g. Is it consistent with our department's values and policies?

If the answer to these questions is yes, then don't ask permission. You are empowered to provide exceptional customer service.

- 5. Create and sustain a positive public image
 - a. Follow Phoenix Regional Standard Operating Procedures.
 - b. Be professional at all times.
 - c. Give the customer your undivided attention.
 - d. Take a moment (when appropriate) to educate the customer(s) about what we do and why we are doing it.

In addition to the above, Company Officers and Command Officers are responsible for the following:

- 1. Provide a work environment in which exceptional customer service and added value are the result of a refined system where members are empowered to operate between the lines to provide caring service with both quality and value.
- 2. Basic organizational behavior must be customer oriented.
- 3. Invest in human resources by keeping customer service a part of an ongoing development process.
- 4. Take responsibility for themselves and their subordinates and expand authority in others.
- 5. Sustain and enhance regional commitment and consistency in the execution of professional services and customer satisfaction.

OPERATIONAL INFORMATION

The organizational benefits of providing exceptional customer service, with added value, are numerous. Benefits include:

- It saves lives and property
- Builds positive relationships and trust within our membership
- Builds positive relationships and trust in our community
- Secures and maintains adequate resources and benefits
- Positive job satisfaction
- Places us in the best position to compete
- It's fun to be nice and do nice things
- It eliminates bad press, liability, and extra paperwork
- It's the right thing to do

**PHOENIX REGIONAL
STANDARD OPERATING PROCEDURES**

Command Procedures

M.P. 201.01

01/18

Page 1 of 38

Purpose

The Phoenix Fire Department responds to a wide range of emergency incidents. In order to effectively manage personnel and resources and to provide for the safety and welfare of personnel, we will always operate within the Incident Command System at the incident scene. This procedure identifies the Standard Operating Procedures to be employed in establishing Command components of the Incident Command System and applicable components of the National Incident Management System (NIMS).

Command Procedures are designed to:

- Fix the responsibility for Command on a certain individual through a standard identification system, depending on the arrival sequence of members, companies, and Command officers.
- Ensure that a strong, direct, and visible Command will be established from the onset of the incident.
- Establish an effective incident organization defining the activities and responsibilities assigned to the Incident Commander (IC) and the other individuals operating within the Incident Command System.
- Provide a system to process information to support incident management, planning, and decision-making.
- Provide a system for the orderly transfer of Command to subsequent arriving officers.
- Ensure a seamless transition from a Type 5/4 incident to a Type 3/2/1 (NIMS).

Roles and Responsibilities within the Incident Command System

Shift Commanders Phoenix (South Deputy), Glendale (West Deputy) and Mesa (East Deputy)

- Manage Battalions and supervise Battalion Chiefs.
- Occupy the position of Senior Advisor (Incident Advisor) on the Command Team (Incident Advisory Team) during first and greater alarm incidents.

Battalion Chiefs

- Manage companies and supervise company officers.
- Occupy the position of Incident Commander (IC) when appropriate.
- Occupy the position of Sector Officer when appropriate.
- Occupy the position of IC on the Command Team (Incident Advisory Team) during first and greater alarm incidents.

**PHOENIX REGIONAL
STANDARD OPERATING PROCEDURES**

Command Procedures

M.P. 201.01

01/18

Page 2 of 38

Company Officers (Captains)

- Occupy the position of IC when appropriate.
- Occupy the position of Sector Officer when appropriate.
- Manage task level activities and supervise firefighters.

Responsibilities of Command

The Incident Commander is responsible for the completion of the tactical objectives. The Tactical Objectives are:

- Rescue
- Fire Control
- Property Conservation

See M.P. 202.02A for more detail explanation

The Incident Command System is used to facilitate the completion of the Tactical Objectives. The Incident Commander is the person who drives the command system towards that end. The Incident Commander is responsible for building a Command structure that matches the organizational needs of the incident to achieve the completion of the Tactical Objectives for the incident. The Functions of Command define standard activities that are performed by the Incident Commander to achieve the Tactical Objectives.

Functions of Command

The Functions of Command include:

1. Assume and announce Command and establish an effective initial command position (Command Post).
2. Rapidly evaluate the situation (size up).
3. Initiate, maintain, and control effective incident communications.
4. Provide and manage a steady, adequate, and timely stream of appropriate resources.
5. Identify the incident strategy, develop an Incident Action Plan (IAP), and assign companies and personnel consistent with plans and standard operating procedures.
6. Develop an effective incident organization using Sectors/Divisions/Groups to decentralize and delegate geographic and functional responsibility.
7. Review, and revise (as needed) the strategy to keep the IAP current.
8. Provide for the continuity, transfer, and termination of Command.

The Incident Commander is responsible for all of these functions. As Command is transferred, so is the responsibility for these functions. The first six (6) functions must be addressed

PHOENIX REGIONAL
STANDARD OPERATING PROCEDURES

Command Procedures

M.P. 201.01

01/18

Page 3 of 38

immediately from the initial assumption of Command. Use of the Strategic Decision Making Model greatly increases effectiveness of the command team.

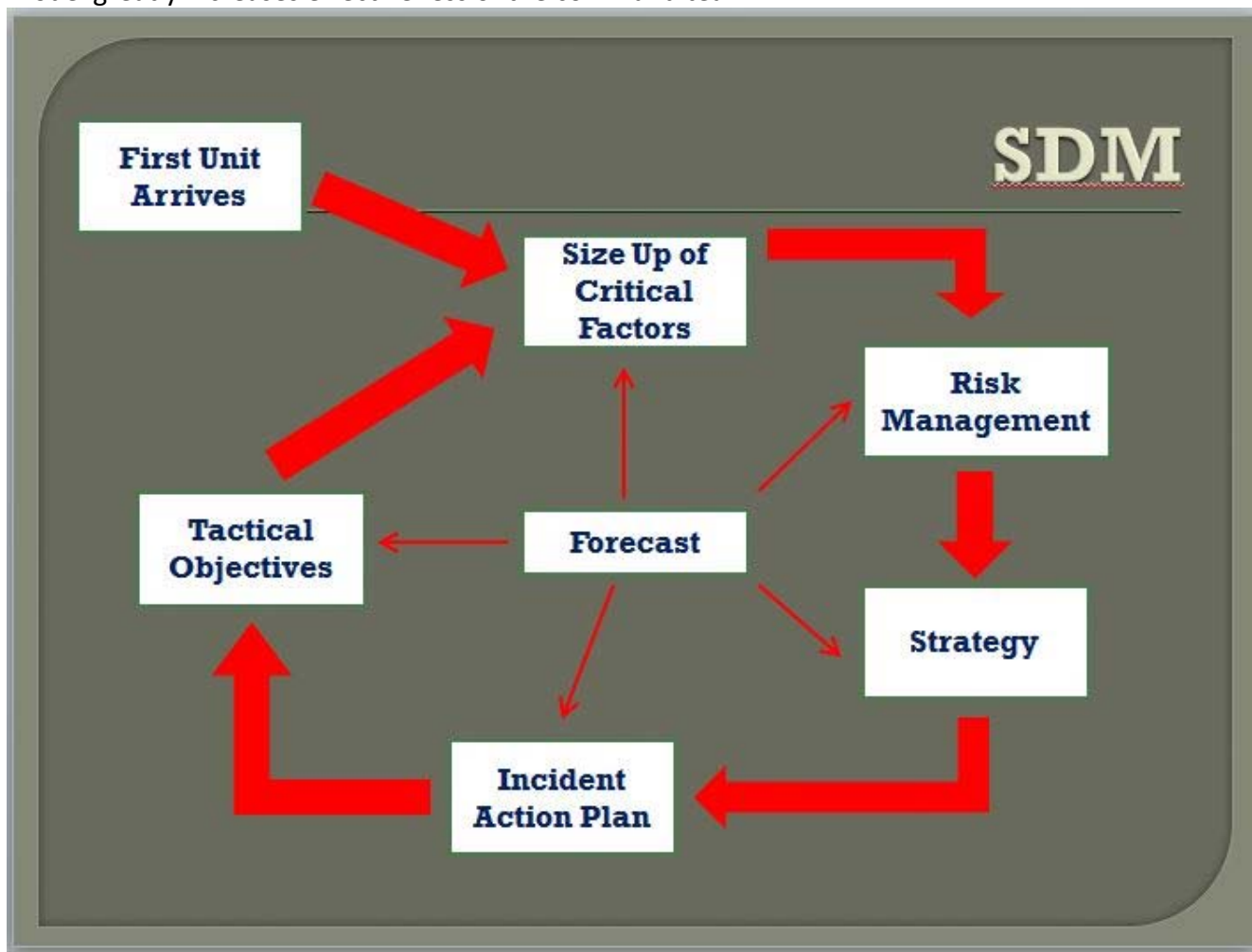

**PHOENIX REGIONAL
STANDARD OPERATING PROCEDURES**

Command Procedures

M.P. 201.01

01/18

Page 4 of 38

Establishing Command

The first fire department member or unit to arrive at the scene of a multiple unit response shall assume command of the incident*. The initial Incident Commander shall remain in Command until Command is transferred, or the incident is stabilized and Command is terminated.

- One or two company responses that are not going to escalate beyond the commitment of these companies do not require the first arriving unit or officer to assume Command. The first arriving unit or officer will, however remain responsible for any needed Command functions. Examples would include:
 - Single unit response
 - Check Hazard
 - Any EMS call requiring only one or two companies

The first arriving fire department unit initiates the command process by giving an initial radio report.

The standard Initial Radio Report includes:

On-Scene Report

1. Clear alarm.
2. Unit designation/on the scene.
3. Building/area description.
 - Occupancy
 - Size (large, medium, small)
 - Height (assumed 1 story unless reported otherwise)
4. Obvious problem/conditions.
 - Nothing showing (indicates checking)
 - Smoke showing (amount and location)
 - Fire showing (amount and location)
 - Working fire
 - Fully involved
5. Action taken.
 - Assuming command
 - Laying a line
 - Attacking with...etc.
6. Declaration of Strategy.
 - Offensive or defensive
7. Command confirmation with name

**PHOENIX REGIONAL
STANDARD OPERATING PROCEDURES**

Command Procedures

M.P. 201.01

01/18

Page 5 of 38

Examples:

For an offensive structure fire -

Engine 11 to Alarm - "Engine 11 is on the scene of a large two-story school with a working fire on the second floor. Engine 11 is laying a supply line and going in with a hand-line to the second floor for search & rescue and fire attack. This is an offensive fire attack. Engine 11 will be 7th Street Command."

For a defensive fire -

Engine 11 to Alarm - "Engine 11 is on the scene of a medium size warehouse fully involved with exposures to the east. Engine 11 is laying a supply line and attacking the fire with a stang gun and a hand-line to the east exposure to check for extension. This is a defensive fire. Engine 11 will be Buckeye Command.

For an E.M.S. incident -

Ladder 11 to Alarm - "Ladder 11 is on the scene with a multi-vehicle accident. Give me the balance of a 2 and 1 medical with three ambulances. Ladder 11 will be Parkway Command."

Follow-up Report

1. Any immediate safety concerns
2. Accountability started (announce the initial accountability location)
3. Disposition of resources (hold/add/return)
4. Disposition of IRIC (only required if IRIC will not be present)

Examples:

For an offensive structure fire -

7th Street Command to Alarm - "Engine 11 will be North side accountability. Give me the balance a 1st Alarm."

For a defensive fire -

Buckeye Command to Alarm – "Engine 11 will be South side accountability. Give me the balance of a 1st Alarm".

For an E.M.S. incident – Parkway Command to Alarm – "be advised we have a total of 3 patients, 2 Immediates and 1 delayed. All patients have been extricated".

**PHOENIX REGIONAL
STANDARD OPERATING PROCEDURES**

Command Procedures

M.P. 201.01

01/18

Page 6 of 38

Radio Designation

The radio designation "COMMAND" will be used along with the occupancy or address of the incident (i.e. "7th Street Command", "Metro Center Command"). This designation will not change throughout the duration of the incident. The designation of "Command" will remain with the officer currently in command of the incident throughout the event.

Command Options

The responsibility of the first arriving unit or member to assume Command of the incident presents several options, depending on the situation. If a Chief Officer, member, or unit without tactical capabilities (i.e. staff vehicle, no equipment, etc.) initiates Command; the establishment of a Command Post should be a top priority. At most incidents, the initial Incident Commander will be the Company Officer. The following Command options define the Company Officer's direct involvement in tactical activities and the modes of Command that may be utilized.

Investigative Mode (Nothing Showing):

This is a mobile IC on a portable radio, moving around and evaluating conditions while looking for the incident problem. The company officer should go with the company to investigate while utilizing a portable radio to command the incident.

Fast Attack:

Visible working fires in houses or commercial occupancies. IC #1 arrives and his/her direct participation in the attack will make a positive difference in the outcome (search and rescue, fire control, and crew safety). They give an initial radio report and quickly assign an attack team (2 engines and ladder) coming in behind them. Next arriving units all stage. IC #1 goes inside (when in the offensive mode) with a portable radio supervising their crew in the attack.

Examples of these situations include:

- Visible working fire in a house or small commercial occupancy.
- Critical life safety situations (i.e. rescue that must be achieved in a compressed time.
- Any incident where the safety and welfare of fire fighters is a major concern.
- Obvious working incidents that require further investigation by the Company Officer.
- Combined crew experience level

In fast attack mode, the IC must initiate and continue command until a command officer arrives and the transfer of command is completed. The entire team responding in behind the fast attackers must realize that the IC is in an attack position inside the hazard zone attempting to

**PHOENIX REGIONAL
STANDARD OPERATING PROCEDURES**

Command Procedures

M.P. 201.01

01/18

Page 7 of 38

quickly solve the incident problem. Responding companies must critically listen to radio traffic, update, review and reinforce the initial size up, verify the safety, welfare, and accountability of the fast attackers, and back up the basic attack.

The Fast-attack-mobile Command mode should not last more than a few minutes and will end with one of the following:

1. Situation is stabilized.
2. Command is transferred from the fast attack company officer IC to a later arriving command officer.
3. If the situation is not stabilized, the fast attack company officer IC must move to an exterior (stationary) command position and is now in the Command mode. The company officer must decide whether or not to withdraw the remainder of the crew, based on the crew's capabilities and experience, safety issues, and the ability to communicate with the crew. No crew will remain in a hazardous area without radio communications.

Command Mode - Stationary Command Post:

Certain incidents, by virtue of their size, complexity, or potential for rapid expansion, demand early, strong, stationary command from the outset. In these cases, the first arriving IC will assume command and, from the very beginning stay out of the hazard zone in a stationary exterior command position. The IC must remain there until the incident is terminated or command is transferred. The tactical worksheet shall be initiated and utilized to assist in managing these types of incidents.

If the Company Officer assumes a Command mode, the following options are available with regards to the assignment of the remaining crew members.

1. *"Move up" an acting officer within the Company.* This is determined by the individual and collective capabilities and experience of the crew.
2. *Assign the crew members to perform staff functions to assist the IC.* Staff functions include recon/reporting, communications assistance; help with tactical worksheet tracking etc.
3. *Assign company personnel to another Company.* This creates a larger work group with an officer. This must be acknowledged by both the original and the receiving officer and by their inclusion in the accountability system.

Transfer of Command

Command is transferred to improve the quality of the Command organization. When Command is transferred, it should trigger upgrades in the Command structure. The following guidelines outline the transfer of Command. Using a standard routine for both establishing and

**PHOENIX REGIONAL
STANDARD OPERATING PROCEDURES**

Command Procedures

M.P. 201.01

01/18

Page 8 of 38

transferring command creates the capability within the responding units for the IC to effectively and safely establish and continue command. Using a fast attack company officer IC (IC #1) in the initial stages of an offensive incident, and then having a subsequent arriving response command officer (IC #2) transfer, strengthens and continues command within the IAP from an upgraded Command Post (CP), in a vehicle, outside the hazard zone, creates a strong, safe, and under control approach. The benefits of an upgraded CP include:

- Provides IC #2 with a Support Officer
- Establishes an Incident Safety Officer (FIT) (ISO)
- IC #2 has a wider view of the fireground
- Improves communication
- Creates a lighted, warm (or cool), and dry environment for IC #2 to operate in

**PHOENIX REGIONAL
STANDARD OPERATING PROCEDURES**

Command Procedures

M.P. 201.01

01/18

Page 9 of 38

Transfer of Command process

1. The first fire department member arriving on the scene will automatically assume Command. This will normally be a Company Officer but could be any fire department member up to and including the Fire Chief.
2. The first arriving Company Officer will assume Command after the Transfer of Command procedures have been completed (assuming an equal or higher ranking officer has not already assumed Command). IC #1 is usually a Company Officer.
3. The first arriving Command Officer should assume Command of the incident following Transfer of Command procedures and becomes IC #2.
4. Subsequent arriving Command Officers should report their location to the IC and wait for an assignment. The first arriving Shift Commander will assume the role of Senior Advisor and assist the IC. The Engineer of the CRV will set up the Command Response Vehicle (CRV) while the Senior Advisor manages the transition of the Command Team to the CRV. The Senior Advisor, IC and Support Officer become the Command Team (Incident Advisory Team). The Command Team may assign additional staff such as a Safety Officer (relieves the Support Officer's ISO responsibility) and a Staging Officer.
5. Assumption of Command is discretionary for Assistant Chiefs and the Fire Chief.
6. Local events that are of long duration or require long term evacuations may require a larger Command staff including Planning Chief, Liaison, and Public Information Officer (PIO). The Assistant Chief of Operations may provide additional support by assisting the Senior Advisor while a Shift Commander manages the evacuation and Command staff.
7. When an incident is so large or of such duration that State or Federal resources are called to assist, an Incident Management Team (IMT) may be assigned to manage these resources. In this case the local jurisdiction having authority (JHA) will maintain Command or delegate authority for managing resources to the IMT. In either case the JHA retains authority to set incident objectives and determine when the IMT, State, and Federal resources are no longer needed.

In certain situations, it may be advantageous for the first arriving IC (i.e. Company Officer) to transfer Command to the next Company ON SCENE. This is indicated when the initial commitment of the first arriving Company requires a full crew (i.e., high-rise or an immediate rescue situation) and another Company or Command Officer is on the scene. When a Chief Officer arrives at the scene at the same time as the initial arriving Company, the Chief Officer should assume Command of the incident.

**PHOENIX REGIONAL
STANDARD OPERATING PROCEDURES**

Command Procedures

M.P. 201.01

01/18

Page 10 of 38

"Passing Command" to a unit that is not on the scene creates a gap in the Command process and compromises incident management. To prevent this "gap", Command shall not be transferred to an officer who is not on the scene.

Should a situation occur where a later arriving Company or Command officer cannot locate or communicate with Command (after several radio attempts), they will assume and announce their assumption of Command and initiate whatever actions are necessary to confirm the safety of the missing crew.

Within the chain of Command, the actual transfer of Command will be regulated by the following procedure:

1. The officer assuming Command (IC #2) will communicate with the person being relieved (IC #1) by radio or face-to-face. Face-to-face is the preferred method to transfer Command.
2. The person being relieved will brief the officer assuming Command indicating at least the following:
 - A. General situation status:
 - 1) Incident conditions (fire location and extent, Hazmat spill or release, number of patients, etc.)
 - 2) Incident Management Plan. Completion of the Tactical Objectives.
 - 3) Safety considerations.
 - B. Deployment and assignments of operating companies and personnel.
 - C. Appraisals of need for additional resources.
3. When an incident becomes so large that an Incident Management Team (IMT) is requested, Command will not transfer to the IMT (Type I/III) unless a formal written Delegation of Authority has been signed by both the JHA and the IMT.

The arrival of a ranking Officer on the incident scene does not mean that Command has been automatically transferred to that Officer. Command is only transferred when the Transfer of Command process has been completed. The person being relieved of Command will be assigned to the best advantage by the Officer assuming Command.

A ranking Officer may elect to have a subordinate continue the role of Incident Commander. In cases where an individual is effectively commanding an incident, and satisfactory progress is being made to bring the incident under control, it may be desirable for that person to continue in an active Command role. The ranking Officer must determine that the Incident Commander is completely aware of the position and function of operating companies and the general status of the situation. In these cases, the arriving ranking Officer may assume a supportive role in the overall Command organization.

**PHOENIX REGIONAL
STANDARD OPERATING PROCEDURES**

Command Procedures

M.P. 201.01

01/18

Page 11 of 38

The response and arrival of additional command officers strengthens the overall Command organization. As the incident escalates, the IC should use these Command Officers to fill Sector (Division), Branch, and Section positions. Command should consider adding a command officer to any sector with three or more operating companies. Strengthening the Command organization:

- Improves safety
- Decreases the span of control
- Improves communication
- Improves accountability
- Improves management and supervision of the Sector

When the first arriving unit is a Command Officer, efforts should be automatically directed towards establishing a Command Post and fulfilling the Command functions. A Command Post in a vehicle equipped for this purpose is a priority at all working incidents. A vehicle that provides appropriate work space for the Incident Commander and staff personnel, lighting, communications equipment, supplies reference items, and some isolation from outside distractions will make Command more effective.

Company and Command Officers should eliminate all unnecessary radio traffic while responding, unless such communications are required to ensure that Command functions are initiated and completed. This requires the initial Incident Commander to give a clear initial radio report and continue to give updated progress reports as needed.

Command Officers should stage over the radio. Staff Personnel should report directly to the Command Post to notify the Incident Commander of their availability to assume incident duties. These personnel should park their vehicles in a location that does not restrict access to the scene.

The IC is responsible for managing the incident. The fire department empowers the IC with the authority to turn his/her decisions into actions (develop an IAP and assign companies). Simply stated, the Incident Commander outranks everybody*. If a higher-ranking Officer wants to affect a change in the management of an incident, he/she must first be on the scene of the incident, and then follow the Transfer of Command procedure.

Anyone can effect a change in incident management in extreme situations relating to safety by notifying Command and initiating corrective action.

The Incident Command System (ICS) never "sleeps". The ICS is in a constant state of readiness. When there are no working incidents the Alarm Headquarters and its Supervisor have the

**PHOENIX REGIONAL
STANDARD OPERATING PROCEDURES**

Command Procedures

M.P. 201.01

01/18

Page 12 of 38

responsibility of initiating the ICS. When the Alarm Room receives notification of a working incident (normally via the telephone) they start the ICS process by giving instruction to the caller and dispatching the appropriate response. The Alarm Room continues in an active management role by ensuring that the first on-scene unit takes Command. The Shift Commander has this responsibility by being the highest ranking on duty member.

Command Team (Incident Advisory Team)

Note: The roles and responsibilities of the Command Team are identical to the roles and responsibilities of the Incident Advisory Team. The Command Team consists of the Incident Commander (IC), Support Officer, and Senior Advisor. On the Incident Advisory Team these roles are filled by the Incident Commander (IC), Support Advisor, and Incident Advisor respectively. Our system uses Command Team terminology but as previously stated the roles and responsibilities for each position remains the same.

A Command Team is an organizational response to quickly provide enough command and control to rapidly bring a significant incident under control. The primary players in the Command Team are the IC, Support Officer, and Senior Advisor.

The incident scene is often dynamic and intense. As the incident grows into and past the requirements of a first alarm assignment, the IC can become overwhelmed with information management, assigning Companies, filling out and updating the tactical worksheet, planning, forecasting, calling for additional resources, talking on the radio, and fulfilling all the other functions of Command. The immediate need of Command at this point is support. In some organizations, the ICs driver (FIT, ISO, BSO etc.) fulfills the role of Support Officer, in organizations without this advantage the IC may choose to utilize the next arriving Command Officer as a Support Officer. The IC may decide to assign the second Command Officer to a Sector (Division) if he/she feels the presence of a Command Officer in a particular Sector will improve safety and communications in that Sector by reducing the span of control.

Establishing an Incident Command Team

The first in command officer, usually a BC with a FIT, or ISO, assumes command (IC #2) from the initial IC (IC #1, usually a company officer). Once IC #2 assumes Command the FIT becomes his/her Support Officer and the designated Incident Safety Officer (ISO) (Note: Some members of the consortium may slightly differ in assigning responsibilities to the FIT/ISO/BSO per their department's SOPs). If the initial assignment stabilizes the situation, this is as far as command needs to grow. If the situation is not stabilized and continues to grow, so does the command organization. The next in command officer (usually a BC) stages on the radio. IC #2 normally assigns this BC to a Sector but if IC #2 does not have a FIT the second BC may be assigned as IC #2's support officer (and ISO) as described earlier in this M.P.

**PHOENIX REGIONAL
STANDARD OPERATING PROCEDURES**

Command Procedures

M.P. 201.01

01/18

Page 13 of 38

The IC and the Support Officer are the first and second members of the Command Team.

It is the Responsibility of the IC to perform the Functions of Command to achieve the Tactical Objectives.

1. Assume and announce Command and establish an effective initial command position (Command Post).
2. Rapidly evaluate the situation (size up).
3. Initiate, maintain, and control effective incident communications.
4. Provide and manage a steady, adequate, and timely stream of appropriate resources.
5. Identify the incident strategy, develop an Incident Action Plan (IAP), and assign companies and personnel consistent with plans and standard operating procedures.
6. Develop an effective incident organization using Sectors/Divisions/Groups to decentralize and delegate geographic and functional responsibility.
7. Review, and revise (as needed) the strategy to keep the IAP current.
8. Provide for the continuity, transfer, and termination of Command.

Roles and Responsibilities of the Support Officer:

- Define, evaluate, and recommend changes to the incident action plan.
- Provide direction relating to tactical objectives and specific critical fireground factors.
- Become the Incident Safety Officer
- Evaluate the need for additional resources.
- Assign logistics responsibilities.
- Assist with the tactical worksheet for control and accountability.
- Evaluate the fireground organization and span of control.
- Other duties as necessary.

The third member of the Command Team is the Senior Advisor. The Senior Advisor is normally the highest-ranking member of the Command Team. The first arriving Shift Commander usually fills the role of the Senior Advisor. The Officer serving as "Command" and the Support Officer will focus on the completion of the tactical objectives, the strategic and tactical plan and the other components of the incident. The Senior Advisor's focus is looking at the entire incident and its impact from a broader perspective and providing direction, guidance and advice to the IC and/or Support Officer.

**PHOENIX REGIONAL
STANDARD OPERATING PROCEDURES**

Command Procedures

M.P. 201.01

01/18

Page 14 of 38

Role and Responsibilities of the Senior Advisor

- Review and evaluate the incident size-up, position in the risk management plan, incident strategy and the incident action plan.
- Based on the review and evaluation of the incident, provide support for the current plan or ensure the appropriate changes are made within the strategic decision making process.
- Provide on-going review of the overall incident (THE BIG PICTURE).
- Review the organizational structure, initiate change or expansion to meet incident needs.
- Initiate Section and Branch functions as required.
- Provide a liaison with other city agencies and officials, outside agencies, property owners and/or tenants.
- Forecast and react to the effect this incident will have on surrounding neighborhoods, Public Officials, and city staffing.
- Prepare to transition to long-term operations by establishing operational periods and advising the Assistant Chief of Operations as to the need for an All Hazards Incident Management Team (AHIMT), state or federal assistance.
- Provide a transitional briefing to the incoming IMT if one has been assigned to the incident.

To maintain continuity and overall effectiveness, the Senior Advisor and Support Officer must be in the Command Post with the IC. The result is there are three people performing the functions of Command. They are working as a team to enhance the Command process and make the functions of Command more effective. The Officer assigned to communicate directly to Companies, Sectors (Divisions or Groups), or Branches will use the radio designation "Command" and should be the only member of the Command Team talking on the tactical radio channel.

Command Structure

It is the responsibility of Command to develop an organizational structure, using standard operating procedures, to effectively manage the incident scene. The development of the organizational structure should begin with deployment of the first arriving fire department unit and continue through a number of phases, depending on the size and complexity of the incident. The Command organization must develop at a pace which stays ahead of the tactical deployment of personnel and resources. In order for the Incident Commander to manage the incident, he/she must first be able to direct, control, and track the position and function of all operating Companies. Building a Command organization is the best support mechanism the

**PHOENIX REGIONAL
STANDARD OPERATING PROCEDURES**

Command Procedures

M.P. 201.01

01/18

Page 15 of 38

Incident Commander can utilize to achieve a balance between managing personnel and incident needs. Simply put, this means:

Large scale and complex incidents = Big Command organization.

Small scale and "simple" incidents = Little Command organization.

- The Incident Commander should have more people working than commanding.
- The basic configuration of Command includes three levels:
 - Strategic Level - Overall direction of the incident.
 - Tactical Level - Objectives assigned to Sectors (Divisions or Groups)
 - Task Level - Task objectives assigned to Companies.

Strategic – This organizational level is designed around the IC and Command Team, operating in the Command Mode, and working out of a stationary command post. The strategic level involves the activities necessary for overall operational control and the completion of the tactical objectives, regardless of the size or complexity of the incident. This is completed most effectively through the strategic decision making model. This includes:

- Provide initial and ongoing size-up and the determination of the critical fireground factors.
- Based on the size-up, define the incident position within the risk management plan
- Determining the appropriate strategy: OFFENSIVE OR DEFENSIVE
- Establishing a strategic level incident action plan for the incident.
- Obtaining and allocating resources.
- Deployment of the appropriate resources.
- Predicting outcomes and planning.
- Assigning specific assignments and objectives to tactical level units.

Tactical - The first management “subdivision” of incident scene organization is accomplished by assigning Sector (Division or Group) responsibilities. Sector officers are responsible for the tactical deployment of assigned resources, evaluation, and communication with the IC. They are assigned by the IC and supervise directly at the site of the assigned activity in order to meet the operational objectives given to them by the IC.

Task – The level of the organization where the work is performed by assigned companies and other resources. The Strategic and Tactical levels are in place to support the task level. Task level activities are routinely supervised by Company Officers. The accumulated achievements of Task Level activities accomplish Tactical Objectives.

**PHOENIX REGIONAL
STANDARD OPERATING PROCEDURES**

Command Procedures

M.P. 201.01

01/18

Page 16 of 38

Command Structure - Basic Organization

Incident organization is the function of command that the IC uses to track, communicate with, and account for resources in order to meet the tactical objectives. For fires this is RESCUE – FIRE CONTROL – PROPERTY CONSERVATION – CUSTOMER STABILIZATION.

Examples:

The most basic Command structure combines all three levels of the Command structure. The Company Officer on a single engine response to a dumpster fire determines the strategy and tactics, and supervises the crew doing the task.



The basic structure for a "routine" incident, involving a small number of Companies, requires only two levels of the Command structure. The role of Command combines the strategic and tactical levels. Companies report directly to Command and operate at the Task Level.

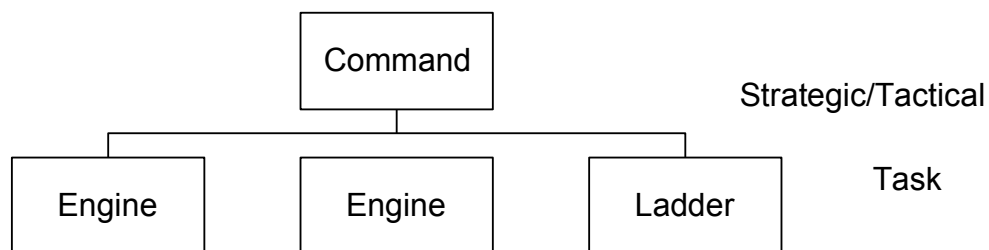

Command Structure - Sectors Basic Operational Approach

A Sector is a smaller, more manageable unit of incident scene organization. Sectoring is a standard system of dividing incident scene command into smaller units or pieces. Whenever there are three or more companies operating in a sector, the IC should assign a Battalion Chief and FIT to that sector. The maximum number of Sectors that an IC can effectively manage is called the span of control. The span of control is usually five sectors and should never exceed seven sectors.

**PHOENIX REGIONAL
STANDARD OPERATING PROCEDURES**

Command Procedures

M.P. 201.01

01/18

Page 17 of 38

Sectors

NOTE: Sectors may be assigned by their geographic location (North Sector) or function (Ventilation Sector). Divisions are assigned by their geographic location (North Division). Groups are assigned by their function (Ventilation Group). For the remainder of this M.P. we will refer to Sectors with the understanding that either Divisions or Groups may be used where appropriate.

A significant problem occurs when the IC requests and assigns additional companies, at a rate that exceeds the development of the incident organization. In short order, the IC will become overloaded with the details of managing a large number of companies scattered all over the incident site. The IC will soon be in the odd situation of being overwhelmed, yet still in need of more resources to accomplish their tactical objectives.

Command must develop and build an organization that matches the deployment of resources to the incident scene. The IC accomplishes this by breaking the incident scene down into manageable subunits called sectors. Sectors are geographic or functional and are managed by Sector Officers.

As Sectors are implemented, Command continues to operate at the strategic level, determining the overall strategy and Incident Action Plan to deal with the incident.

Basic Incident Command Organization

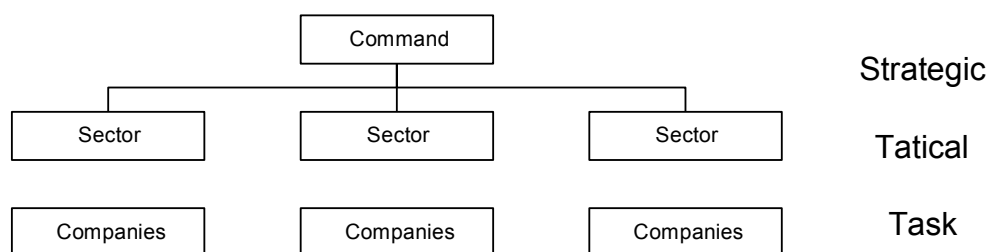

When the number of Sectors exceeds the span of control that the Incident Commander can effectively manage, the Incident Organization should be divided to Branches. Each Branch is responsible for several Sectors and should be assigned a separate radio channel. Branches will be addressed later in this M.P.

Once effective sectors have been established, the IC can concentrate on the overall strategy, incident action plan management, evaluation, and resource allocation. Each of the sector officers becomes responsible for the tactical deployment of the resources assigned to his/her sector and communicating needs and progress back to Command.

**PHOENIX REGIONAL
STANDARD OPERATING PROCEDURES**

Command Procedures

M.P. 201.01

01/18

Page 18 of 38

Utilizing Sectors provides the following advantages:

- *Reduces the IC's span of control* – divides the incident scene into more manageable units.
- *Creates more effective incident scene communications* – permits the IC to exchange information with a limited number of individuals (Sector Officers) who directly supervise teams of firefighters. This reduces overall radio traffic by allowing firefighters and sector officers to communicate face to face instead of by radio.
- *Provides a standard and logical system to divide large geographical incidents into effectively sized units* – allows the IC to concentrate on strategy from one standard command post location.
- *Provides an array major support functions* – these are to be selected and assigned according to the particular needs of each situation. The execution and details of these specific operations becomes the responsibility of the sector officer, not command.
- *Improves firefighter safety* – allows each sector officer to maintain more direct control of the position and function of the companies assigned to their sectors at all times. Sector officers concentrate on their assigned areas and are in a position to move personnel based on incident conditions and the IC's decisions.

Command Should Assign Sectors Based on the Following Factors:

1. When the number of assigned and operating companies threatens to overload the IC's ability to command. Direct tactical-level control should be delegated (earlier than later) to sector officers before the IC's ability to manage is exceeded.
2. When the IC forecasts that the situation will become a major operation, soon exceeding his/her span of control.
3. When companies are involved in complex operations (Large interior or geographic area, hazardous materials, technical rescues, etc.)
4. When companies are operating from tactical positions which Command has little or no direct control over (i.e. out of sight).
5. When the situation presents special hazards and close control is required over operating companies (i.e., unstable structural conditions, hazardous materials, heavy fire load, marginal offensive situations, etc.).
6. Name the sector according to its function or geographical location.

When establishing a Sector, the IC will assign each Sector Officer:

1. Tactical Objectives.
2. A radio designation (Roof Sector, East Sector, etc.)
3. The identity of resources assigned to the Sector.

**PHOENIX REGIONAL
STANDARD OPERATING PROCEDURES**

Command Procedures

M.P. 201.01

01/18

Page 19 of 38

Sectors Will Be Regulated by The Following Guidelines:

- It will be the ongoing responsibility of Command to assign Sectors as required for effective emergency operations; this assignment will relate to both geographic and functional Sectors.
- Command shall advise each Sector Officer of specific Tactical Objectives. The overall strategy and plan will and should be also provided (time permitting), so the Sector Officer has some idea of what's going on and how his assignment fits in.
- The number of Companies assigned to a Sector will depend upon conditions within that Sector. Command will maintain an awareness of the number of Companies operating within a Sector and the capability of that Sector Officer to effectively direct operations. If a Sector Officer cannot control the resources within the Sector, he/she should notify the Incident Commander so that Sector responsibilities can be split or other corrective action taken. During offensive fires five (5) companies represents a reasonable maximum span of control for a Sector Officer. During defensive fires seven (7) companies represents a reasonable maximum span of control.
- Sectors assigned to specific operating areas will be designated by directions (East Sector, North Sector, etc.). Where the incident has odd geographic boundaries (Grand Avenue) it may be confusing to assign directional designations to Sectors (East Sector, etc.). An alternate use of Sector A, B, C, or D, pronounced: Alpha, Bravo, Charlie and Delta respectively, may be used (see page 20). Sector "A" would be the front (street address side) of the building and the other Sectors would go clockwise around the building in alphabetical order.

In multi-story occupancies, Sectors will usually be indicated by floor numbers (Sector 15 indicates 15th floor). In some cases, the floor Sector identification may be subdivided into geographic areas such as "Sector 15 East" or "Sector 15 West" depending on stairwell and floor access. Functional Sectors will be identified by the function (Loss Control Sector, Safety Sector, Ventilation Sector, etc.).

Sector Officers will use the Sector designation in radio communications (i.e. "North Sector to Command").

In many cases, the initial Sector responsibility will be given to the Company Officer who receives the initial assignment to a basic tactical position or function (north, treatment, roof, etc.)

As the incident expands, Command Officers will be assigned Sector responsibilities.

Command will assign a Command Officer to assume Sector responsibilities as soon as possible.

**PHOENIX REGIONAL
STANDARD OPERATING PROCEDURES**

Command Procedures

M.P. 201.01

01/18

Page 20 of 38

Regular Transfer of Command procedures will be followed in transferring Sector responsibility.

In some cases, a Sector Officer may be assigned to an area/function initially to evaluate and report conditions and advise Command of needed tasks and resources. The assigned Officer will proceed to the Sector, evaluate and report conditions to the Incident Commander, and assume responsibility for directing resources and operations within his/her assigned area of responsibility.

The Sector Officer must be in a position to directly supervise and monitor operations. This will require the Sector Officer to be equipped with the appropriate protective clothing and equipment for his/her area of responsibility. Sector Officers assigned to operate within the hazard zone must be accompanied by a partner (normally a F.I.T.). The Sector Officer should be readily identifiable and maintain a visible position as much as possible.

Sector Officers will be responsible for the following basic functions:

- Directly supervise work in the sector.
- Monitor personnel safety, accountability, and welfare.
- Develop a sector IAP that integrates with the overall IAP.
- Monitor work progress.
- Redirect activities as necessary.
- Coordinate actions with related activities, and adjacent Sectors.
- Monitor welfare of Sector personnel.
- Request additional resources as needed (on-deck crews etc.).
- Manage Maydays within the Sector.
- Advise the IC of situation status, changing conditions, progress, completion, and exception reports.
- Re-allocate resources within the Sector
- Provide information for both formal and informal After-Action Reviews (critiques).
- De-commit companies as operations are completed.

When a command officer is assigned Sector responsibilities the FIT/ISO becomes the Sector Safety Officer.

**PHOENIX REGIONAL
STANDARD OPERATING PROCEDURES**

Command Procedures

M.P. 201.01

01/18

Page 21 of 38

Role of the FIT/ISO as a Sector Safety Officer (partnered with BC)

- Perform Sector Safety Officer function/role
- Assess safety concerns within sector
- Assist the BC with managing the sector (stay together)
- Manage accountability within the sector (hose tags too)
- Provide air management within the sector
- Manage work/rest cycles within the sector
- Manage the sector's On-Deck crews recycle and rehab
- Establish communications with Safety Section (you will call them 'Command') once the IC has established the position and assigned a Safety Channel
- Coordinate with other sector safety officers

The primary function of a Company Officer working within a Sector is to direct the operations of their individual crews in performing assigned tasks. Company Officers will advise their Sector Officer of work progress, preferably face-to-face. All requests for additional resources or assistance within a Sector must be directed to the Sector Officer. Sector Officers will communicate with "Command".

Each Sector Officer will keep Command informed of conditions and progress in the Sector through regular progress reports. The Sector Officer must prioritize progress reports to essential information only.

Command must be advised immediately of significant changes, particularly those involving the ability or inability to complete an objective, hazardous conditions, accidents, structural collapse, etc.

When a Company is assigned from Staging to an Operating Sector, the Company will be told what Sector and which Sector Officer they will be reporting to. The Sector Officer will be informed of which particular companies or units have been assigned by the Incident Commander.

It is then the responsibility of the Sector Officer to contact the assigned Company to transmit any instructions relative to the specific action requested.

Sector Officers will monitor the condition of the crews operating in their Sector. Relief crews will be requested in a manner to safeguard the safety of personnel and maintain progress toward the Sector objectives.

Sector Officers will insure an orderly and thorough reassignment of crews to Rehab Sector. Crews must report to rehab intact to facilitate accountability.

PHOENIX REGIONAL
STANDARD OPERATING PROCEDURES

Command Procedures

M.P. 201.01

01/18

Page 22 of 38

SECTOR
DESIGNATION

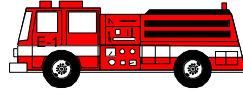

North Sector

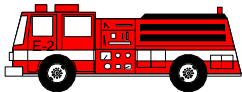
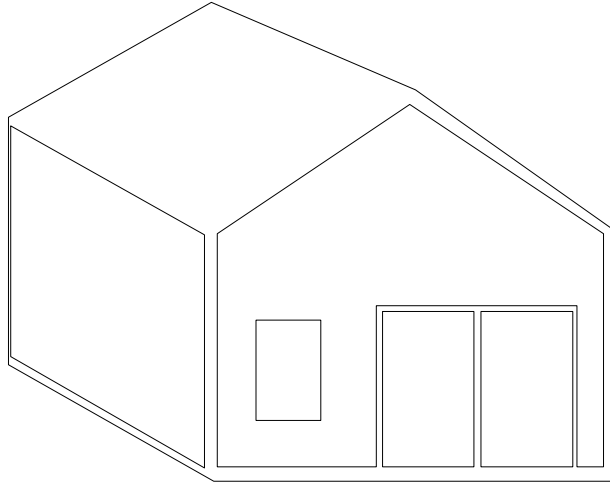

West Sector



East Sector



South Sector



Command

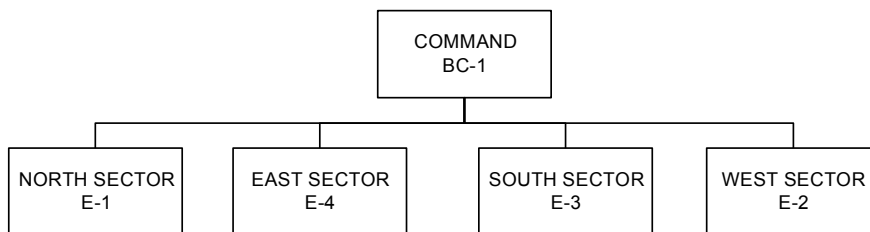

PHOENIX REGIONAL
STANDARD OPERATING PROCEDURES

Command Procedures

M.P. 201.01

01/18

Page 23 of 38

SECTOR DESIGNATION

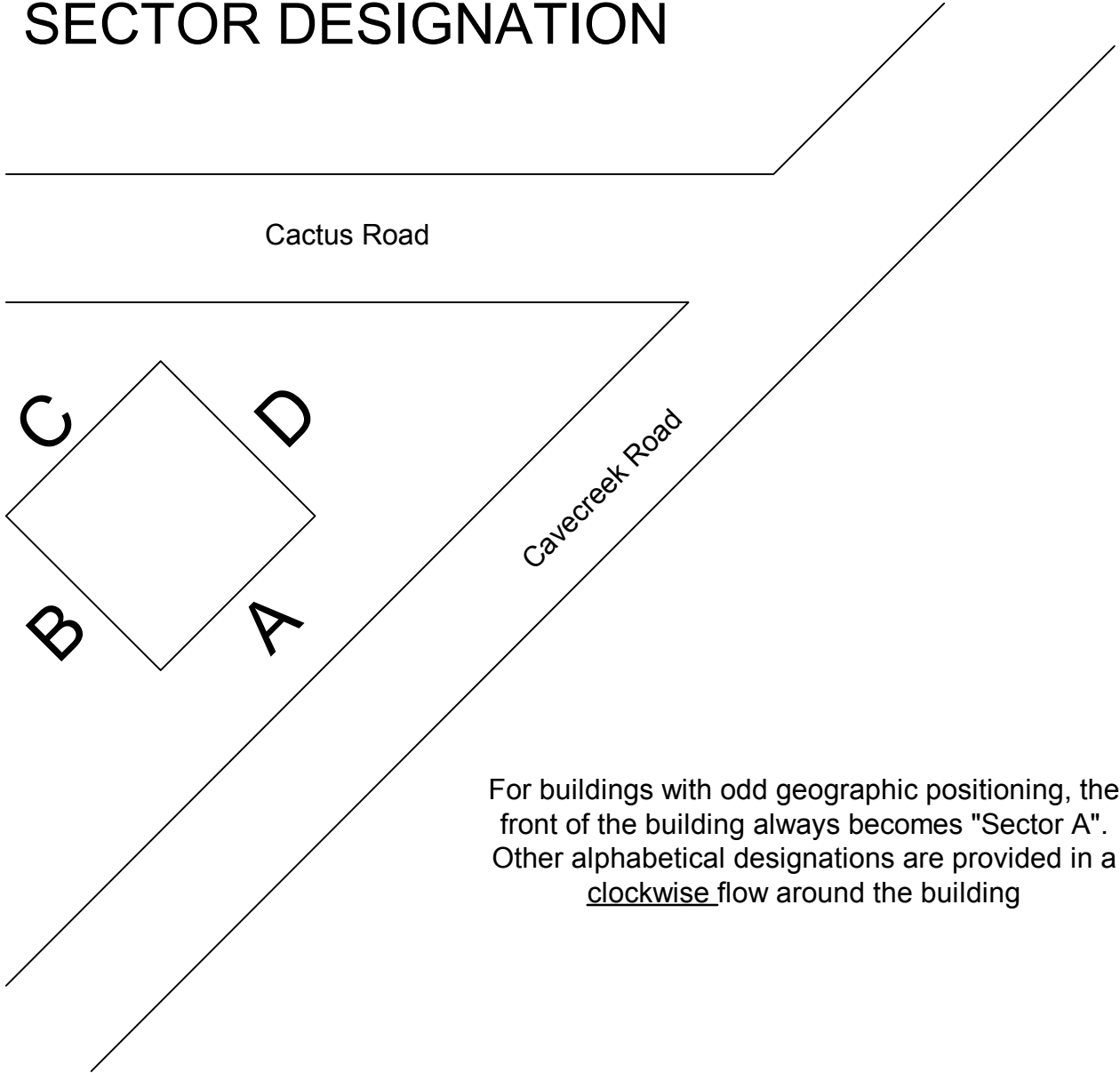

For buildings with odd geographic positioning, the front of the building always becomes "Sector A". Other alphabetical designations are provided in a clockwise flow around the building

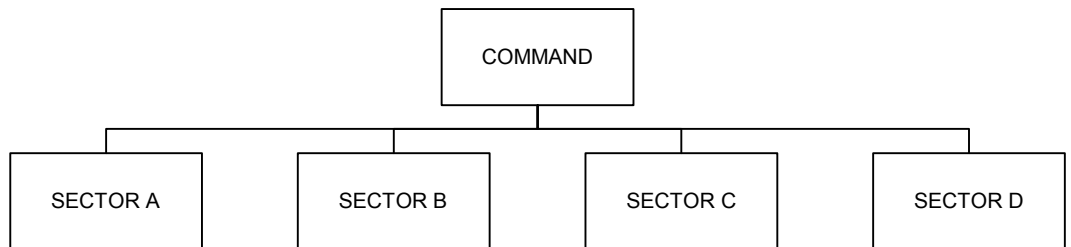

PHOENIX REGIONAL
STANDARD OPERATING PROCEDURES

Command Procedures

M.P. 201.01

01/18

Page 24 of 38

SECTOR DESIGNATION

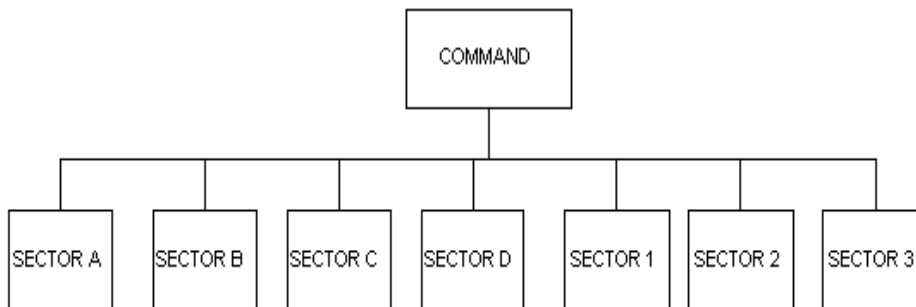
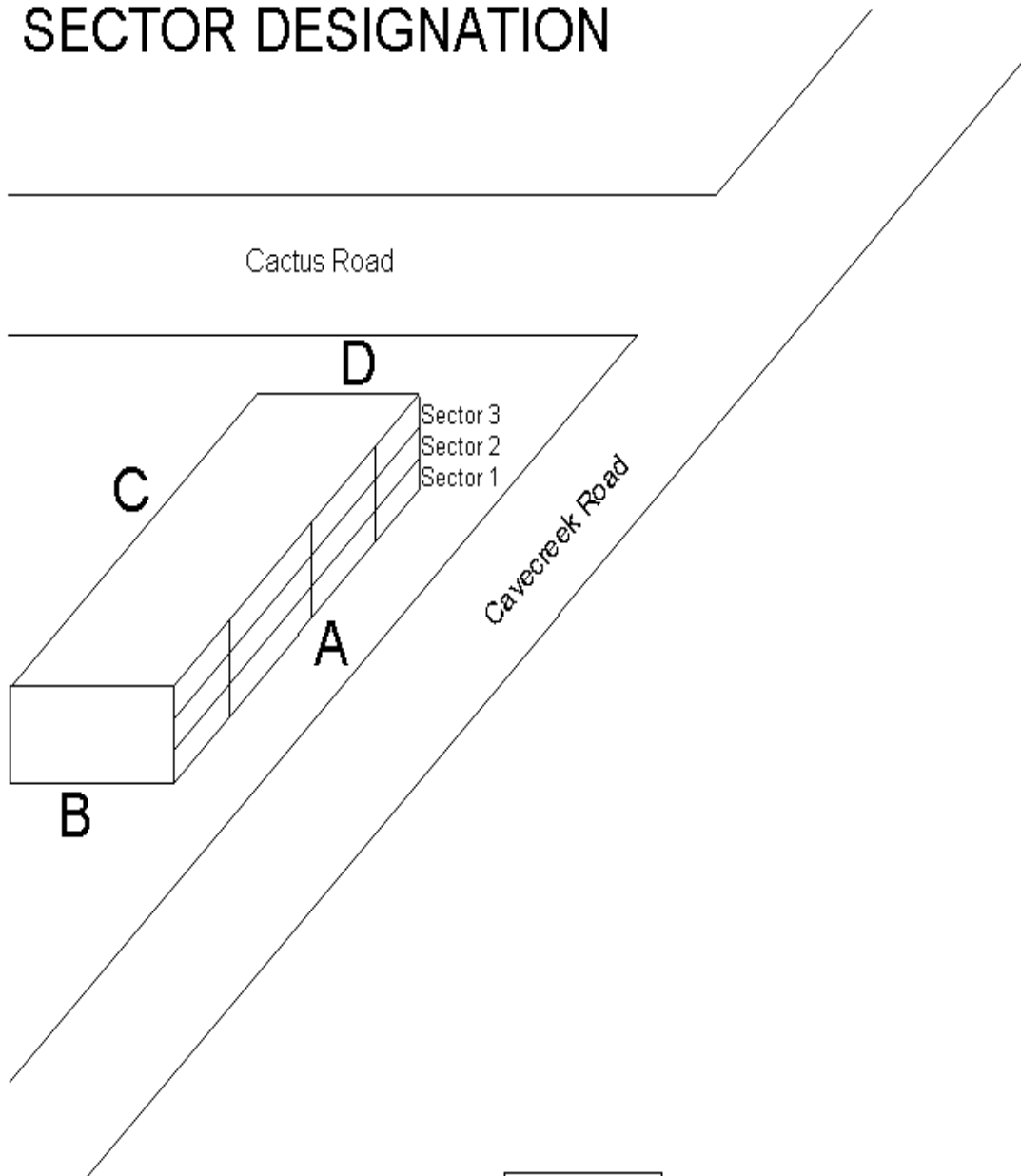

**PHOENIX REGIONAL
STANDARD OPERATING PROCEDURES**

Command Procedures

M.P. 201.01

01/18

Page 25 of 38

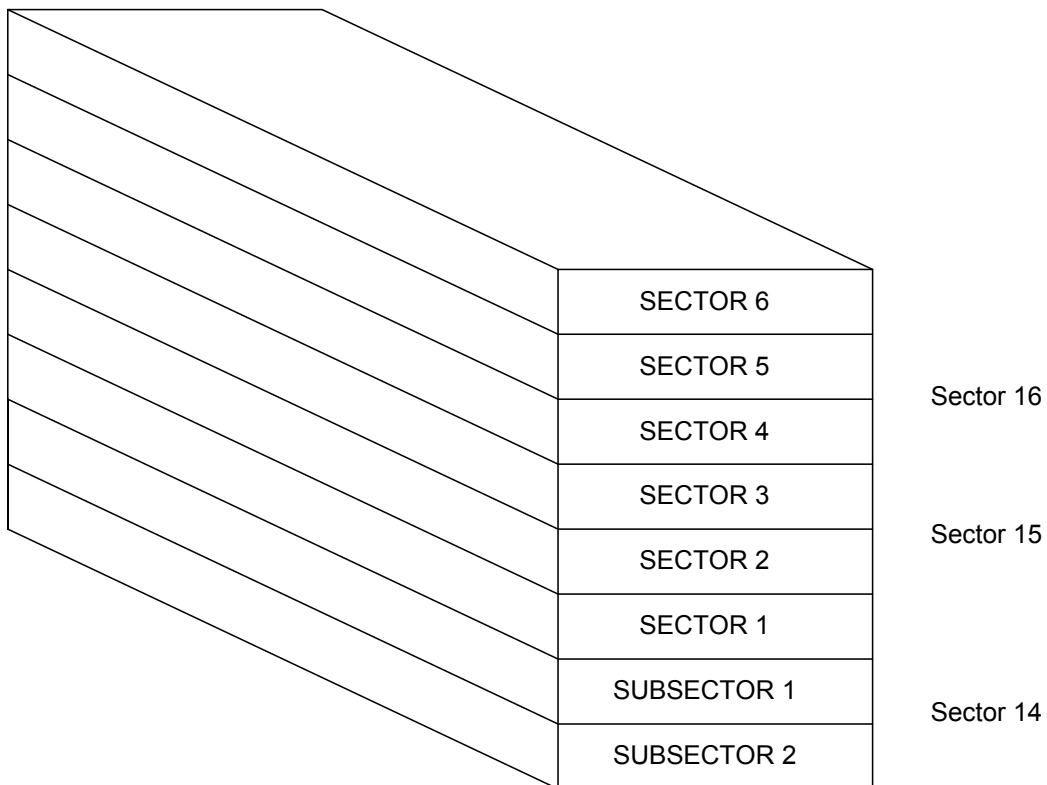

In multi-story occupancies, Sectors will be designated by floor number (Sector 6 indicates the 6th floor). In some cases the floor division identification may be subdivided into geographic areas such as "Sector 6 West" or "Sector 2 North" depending on stairwell and floor access. When operating in levels below grade such as basements the use of Sector is appropriate.

**PHOENIX REGIONAL
STANDARD OPERATING PROCEDURES**

Command Procedures

M.P. 201.01

01/18

Page 26 of 38

Command Structure - Expanding the Organization; Branch Officers

The Branch level of the organization is designed to provide COORDINATION between the Sectors and Command. Adding Branches to the incident organization decreases the communication load on the IC. Branch officers supervise and manage a number of Sector Officers, and report to the Incident Commander.

As the incident organization grows in complexity, and the span of control with Sectors is maximized, the Command Team (described on pages 12-14), may determine that an additional intermediate level within the Command Organization is needed. The Command Team will be working in a stationary command post (the Command Response Vehicle) and the Senior Advisor has the responsibility to decide whether or not to expand the organization to include branches.

- Strategic Level - Incident Commander
- Coordination Level - Branch Officers
- Tactical Level - Sector Officers
- Task Level - Companies

Branch Officers should be utilized at incidents where the span of control with Sectors is maximized or incidents involving two or more distinctly different major management components (i.e. a large fire with a major evacuation, a large fire with a large number of patients). The Incident Commander may elect to assign Branch Officers as forward positions to coordinate the activities between Sectors.

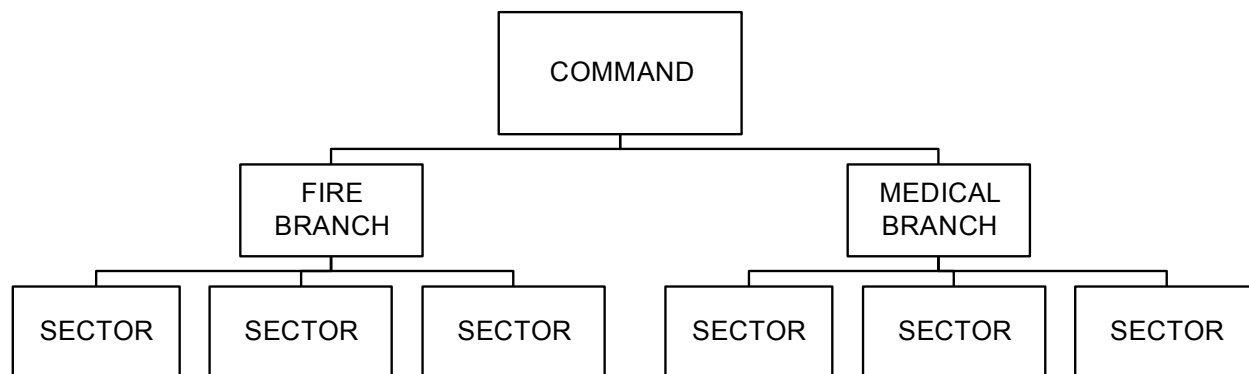

**PHOENIX REGIONAL
STANDARD OPERATING PROCEDURES**

Command Procedures

M.P. 201.01

01/18

Page 27 of 38

The intent of the Branch Level of the Command structure is to split an incident into manageable components and reduce the span of control. Branch Officers will normally be utilized at very large-scale incidents that involve two or more major components. The following types of incidents are examples where Branch Officers should be utilized:

- A Haz mat incident that requires a major evacuation.
- A large-scale incident spread over a wide geographic area.
- An incident with mass casualties and a significant hazard (for example: fire, Haz mat, plane crash, floods, etc.)
- Campaign high-rise fires
- Any incident where the number of Sectors exceed the span of control that can be effectively managed by the incident commander.

Branch Officers manage and direct activities of Sector Officers. Branch Officers operate on the Tactical Channel when sending or receiving information from Command. The radio designation of Branch Officers should reflect the function or geographic area of the Branch (for example: Fire Control Branch, Medical Branch, West Branch, etc.).

When Command Implements Branch Officers the IC will assign a separate radio channel (not the tactical channel) for communications within the Branch. Sector Officers should be notified by Command of their new supervisor. This information should include:

- What Branch the Sector is now assigned to?
- The radio channel the branch (and Sector) is operating on.

Radio Communications will then be directed from the Sector Officer to the Branch Officer. Sector officers will still use the radio designation of Command when contacting their Branch Officer. Sector Officers will relay Branch and radio channel information to the Companies working in their Sector.

Note: When providing radio information to the companies in their sector, Sector officers should obtain a PAR and insure that all members working in the sector are operating on the assigned radio channel.

Communications between the IC and Fire Branch are on the Tactical radio channel and radio designations are: "Command to Fire Branch" and "Fire Branch to Command".

Communications between Fire Branch and West Sector are on channel A and radio designations are: "Command to West Sector" and "West Sector to Command"

**PHOENIX REGIONAL
STANDARD OPERATING PROCEDURES**

Command Procedures

M.P. 201.01

01/18

Page 28 of 38

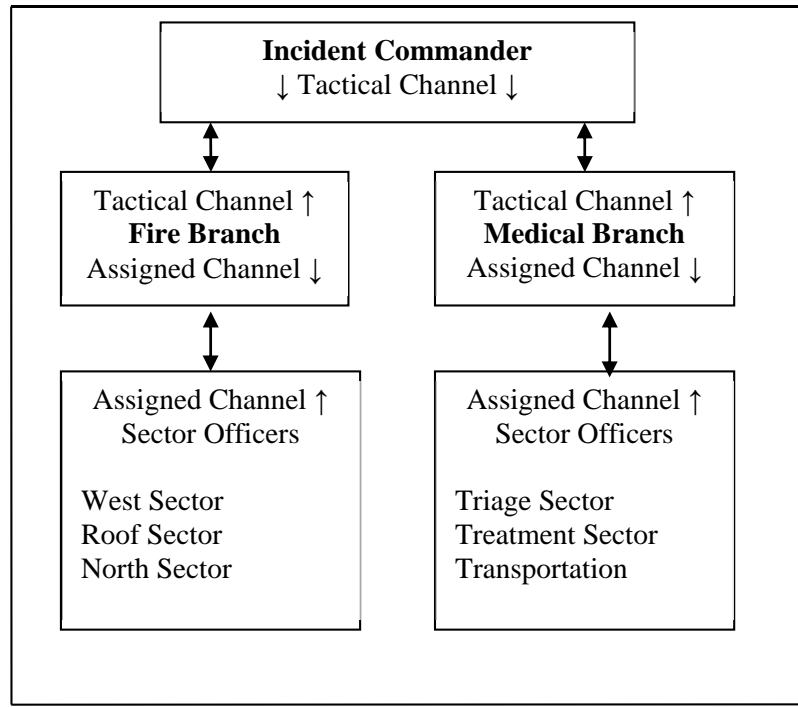

Branch Officers positions should be assigned to Chief Officers. Branch Officers operate in forward positions. They should utilize a Command Officer's vehicle as a forward Branch Command Post (when feasible). In these situations, Command must assign Officers in the Command Post to monitor each Branch radio channel.

Branch Officers are not limited to Operations. Any of the Section Officers may implement Branches within their individual sections as needed.

PHOENIX REGIONAL
STANDARD OPERATING PROCEDURES

Command Procedures

M.P. 201.01

01/18

Page 29 of 38

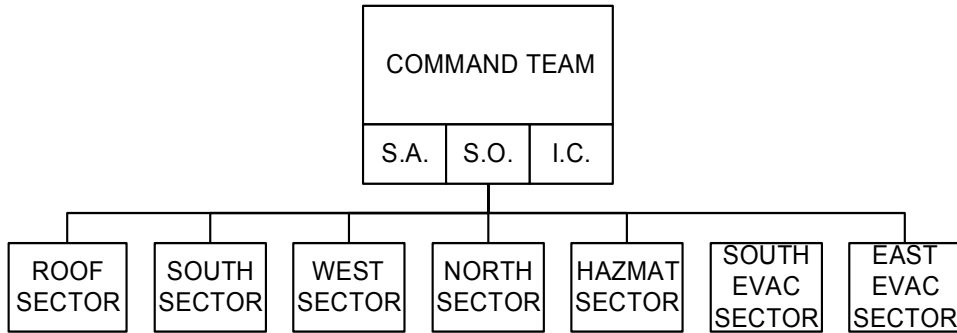

Organization expands from this...
... to this

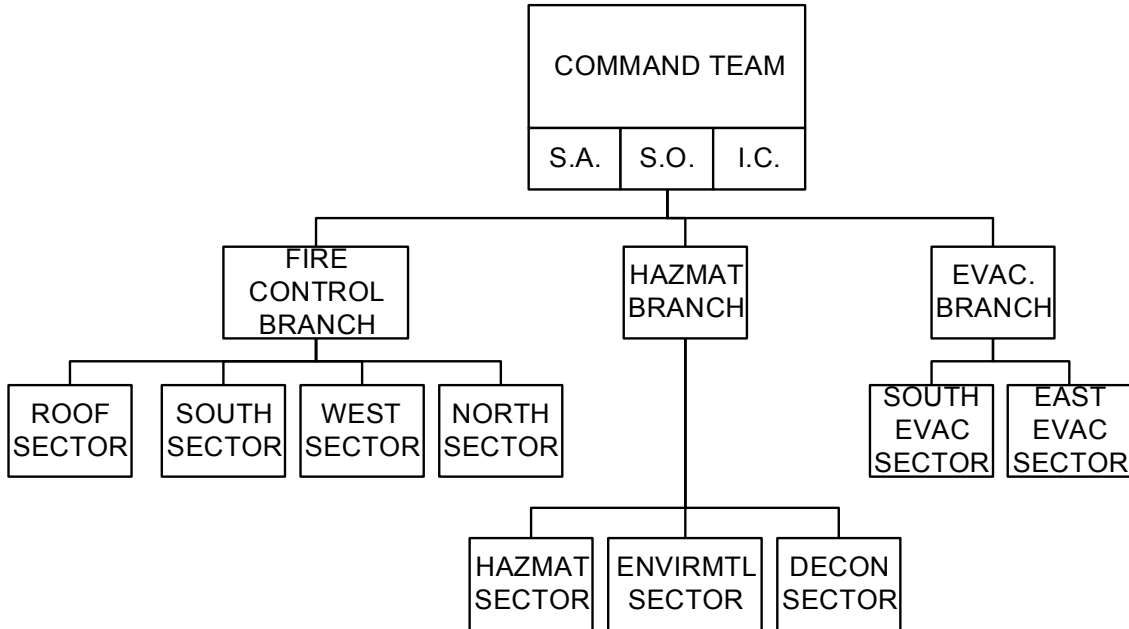

**PHOENIX REGIONAL
STANDARD OPERATING PROCEDURES**

Command Procedures

M.P. 201.01

01/18

Page 30 of 38

Command Structure - Expansion to Major Operations

Sections

As a small incident escalates into a major incident, additional organizational support will be required. As additional ranking Officers arrive on the scene, the Command Post organization (Team) may be expanded through the involvement of Command Officers and staff personnel to fill section positions. Section Officers assist the Incident Command Staff with the long-term management of the incident and operate at the Strategic Level. The Incident Commander Implements Sections as needed, depending on the situation, and priority of needs (One incident may only require a Logistics Section while another incident may require all the sections to be implemented.)

Where the communications system permits, Section Officers should operate on separate radio channels and utilize the radio designation that identifies their section (Planning, Logistics, etc.).

During the initial phases of the incident the initial Incident Commander and his/her staff normally carry out these four section functions. The Fire Department's involvement and needs at the incident scene can be divided into four sections. They are:

LOGISTICS SECTION

PLANNING SECTION

OPERATIONS SECTION

ADMINISTRATIVE SECTION

**PHOENIX REGIONAL
STANDARD OPERATING PROCEDURES**

Command Procedures

M.P. 201.01

01/18

Page 31 of 38

The Logistics Section is the support mechanism for the organization. Logistics provides services and support systems to all the organizational components involved in the incident. Command may assign the Logistics Section its own radio channel. The Logistic Section Officer may establish Sectors or branches for his/her section as needed.

Roles and Responsibilities:

- Provide rehab.
- Manage staging
- Provide and manage any needed supplies or equipment.
- Forecast and obtain future resource needs (coordinate with the Planning Section).
- Provide any needed communications equipment.
- Provide fuel and needed repairs for equipment.
- Obtain specialized equipment or expertise per Command.
- Provide food and associated supplies.
- Secure any needed fixed or portable facilities.
- Provide any other logistical needs as requested by Command.
- Collect and provide information for an After-Action Review.
- Supervise assigned personnel

**PHOENIX REGIONAL
STANDARD OPERATING PROCEDURES**

Command Procedures

M.P. 201.01

01/18

Page 32 of 38

The Planning Section is responsible for gathering, assimilating, analyzing, and processing information needed for effective decision-making. Information management is a full-time task at large and complex incidents. The Planning Section serves as the Incident Commander's "clearing house" for information. This allows the Incident Commander to have a single person provide him/her with information instead of having to deal with dozens of information sources. Critical information should be immediately forwarded to Command (or whoever needs it). Information should also be used to make long-range plans. The Planning Section Chief's goal is to plan ahead of current events and to identify the need for resources before they are needed.

Roles and Responsibilities

- Evaluate current strategy and plan with the Incident Commander.
- Refine and recommend any needed changes to plan.
- Evaluate Incident Organization and span of control.
- Forecast possible outcome(s).
- Evaluate future resource requirements.
- Utilize technical assistance as needed.
- Evaluate tactical priorities, specific critical factors, and safety.
- Gather, update, improve, and manage information with a standard systematic approach.
- Facilitate an After-Action Review and After-Action Report.
- Liaison with any needed outside agencies for planning needs.

**PHOENIX REGIONAL
STANDARD OPERATING PROCEDURES**

Command Procedures

M.P. 201.01

01/18

Page 33 of 38

The Operations Section is responsible for the tactical priorities, accountability, safety and welfare of the personnel working in the Operations Section. The Operations Section Officer uses the tactical radio channel to communicate strategic and specific objectives to Sector Officers and/or Branch Officers.

Roles and Responsibilities:

- Coordinate activities with the Incident Commander.
- Implement the Incident Management Plan.
- Assign units to Sectors/Branches based on Tactical Objectives.
- Build an effective organizational structure through the use of Branches and Sectors.
- Provide Branches and Sectors Tactical Objectives.
- Manage Operation Section activities.
- Personnel Accountability.
- Provide for life safety.
- Determine needs and request additional resources.
- Consult with and inform other sections and the Incident Command Staff as needed.
- Collect and provide information for an After-Action Review.

If the Operations Officer is located at the Command Post, he/she should use the radio designation of "Command". The vast majority of incidents can be effectively managed without an Operations Officer, or with the Operations Officer located at the Command Post. If the Operations Officer is located out of the Command Post at a "forward" position (i.e. in a high-rise building), he/she should use the radio designation of "Operations".

Implementing an "Operations" radio designation in the middle of a major incident can create confusion with radio communications. It is absolutely essential that all personnel operating at the incident be made aware of the activation of "Operations". All Sector Officers and/or Branch Officers must then direct their communications to the "Operations" Officer.

The Operations Officer will communicate with the Incident Commander to request additional resources, provide progress reports, etc.

Once implemented, "Operations" becomes a forward Command Post. As such the Operations Officer will need some personnel assigned to assist as staff members to help with radios, tactical worksheets, etc.

**PHOENIX REGIONAL
STANDARD OPERATING PROCEDURES**

Command Procedures

M.P. 201.01

01/18

Page 34 of 38

The Incident Commander - Role and Responsibilities after Activation of an Operations Officer

Once the Operations Officer is in place and functioning, the Incident Commander's focus should be on the strategic issues, overall strategic planning and other components of the incident. This focus is to look at the "big picture" and the impact of the incident from a broad perspective. The Incident Commander should provide direction, advice and guidance to the Operations Officer in directing the tactical aspects of the incident.

- Review and evaluate the plan and initiate any needed changes.
- Provide on-going review of the overall incident (THE BIG PICTURE).
- Select priorities.
- Provide direction to the Operations Officer.
- Review the organizational structure, initiate change or expansion to meet incident needs.
- Initiate Section and Branch functions as required.
- Establish liaison with other city agencies and officials, outside agencies, property owners and/or tenants.
- Collect and provide information for an After-Action Review.
- Other duties as necessary.

In order to maintain continuity and overall effectiveness, the Incident Commander and Operations Officer should normally be in the Command Post together.

**PHOENIX REGIONAL
STANDARD OPERATING PROCEDURES**

Command Procedures

M.P. 201.01

01/18

Page 35 of 38

The Administration Section evaluates and manages the risk and financial requirements for the Fire Department's involvement in the incident.

Roles and Responsibilities:

- Procurement of services and/or supplies from sources within and outside the Fire Department or City as requested by Command (coordinates with Logistics).
- Documenting all financial costs of the incident.
- Documenting for possible cost recovery for services and/or supplies.
- Analyzing and managing legal risk for incidents such as, hazardous materials clean up.
- Serves as the Incident Commander's liaison with: City officials, Litigators (and other lawyer types). Regulatory agencies (EPA, OSHA, DOT, FBI, etc.).
- Monitors and coordinates emergency service delivery to the rest of the community during major incidents to ensure adequate coverage.
- Serves as the E.O.C. representative in the Command Post and provides briefings to the E.O.C. staff.
- Manage investigations (arson, etc.).
- Collect and provide information for an After-Action Review.

The Administration Section is responsible for obtaining any and all needed incident documentation for potential cost recovery efforts, or litigation, including criminal charges.

PHOENIX REGIONAL
STANDARD OPERATING PROCEDURES

Command Procedures

M.P. 201.01

01/18

Page 36 of 38

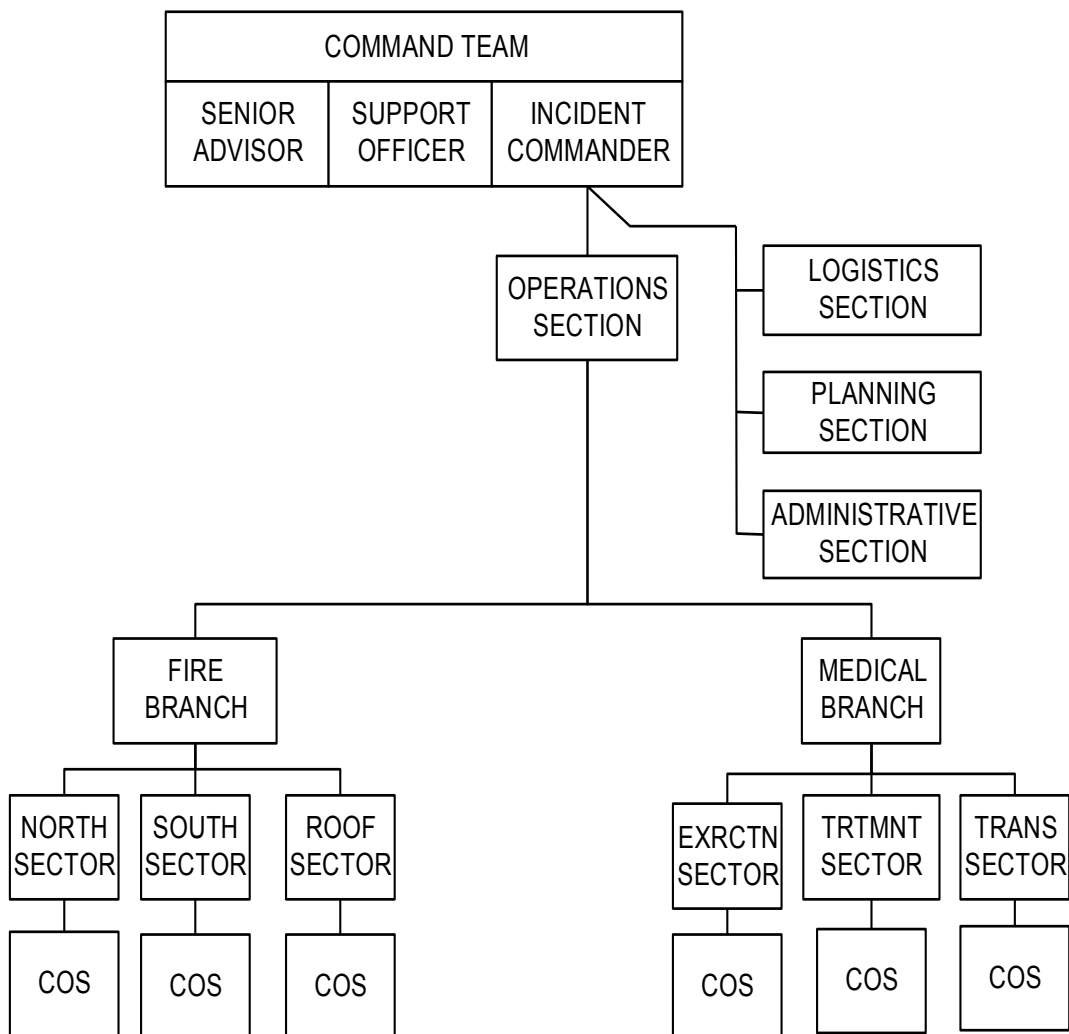

Command Structure -- Expanding the Organization; Sections in place

**PHOENIX REGIONAL
STANDARD OPERATING PROCEDURES**

Command Procedures

M.P. 201.01

01/18

Page 37 of 38

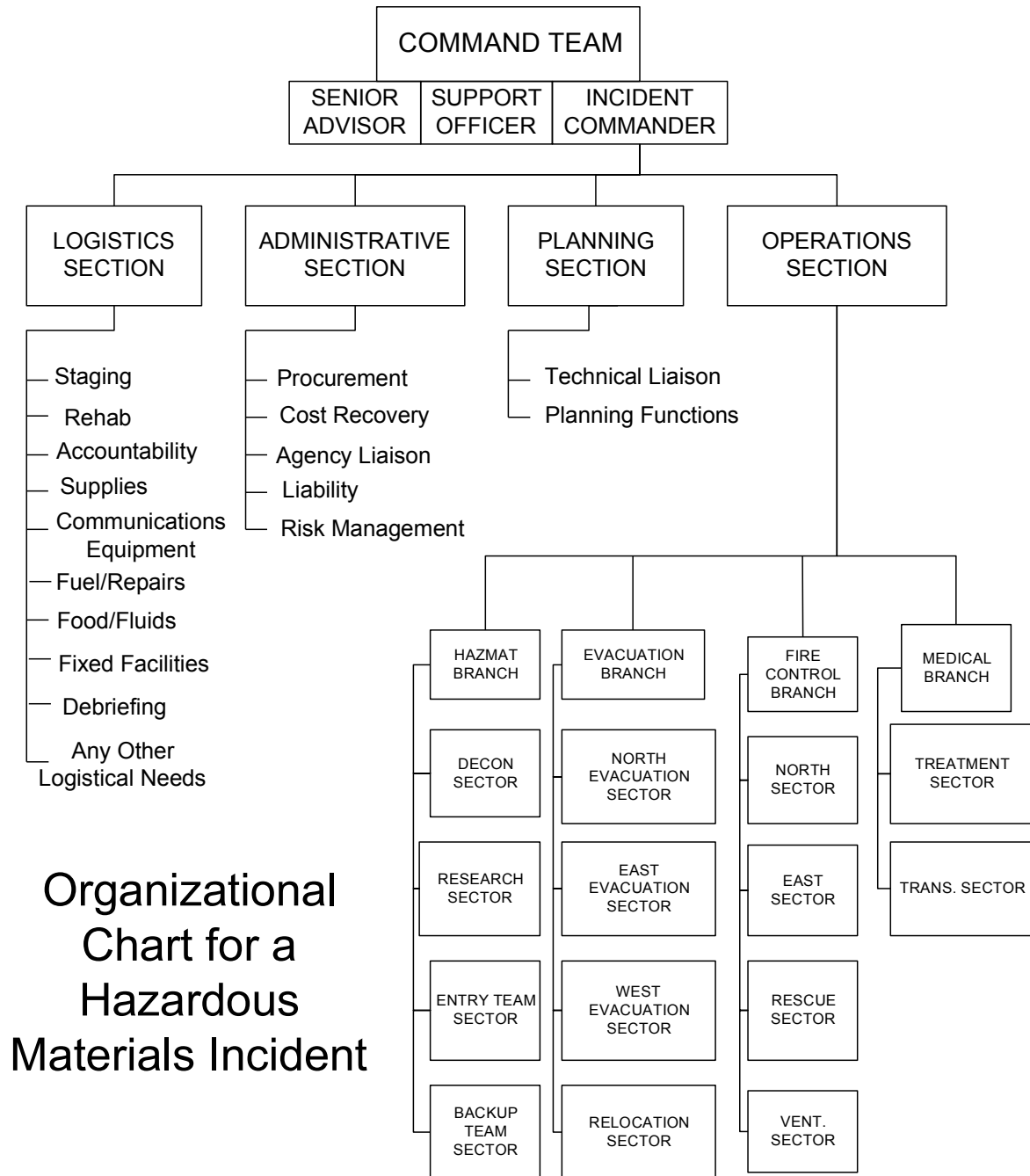

**Organizational
Chart for a
Hazardous
Materials Incident**

Expanding the Organization -- Major Incident

**PHOENIX REGIONAL
STANDARD OPERATING PROCEDURES**

Command Procedures

M.P. 201.01

01/18

Page 38 of 38

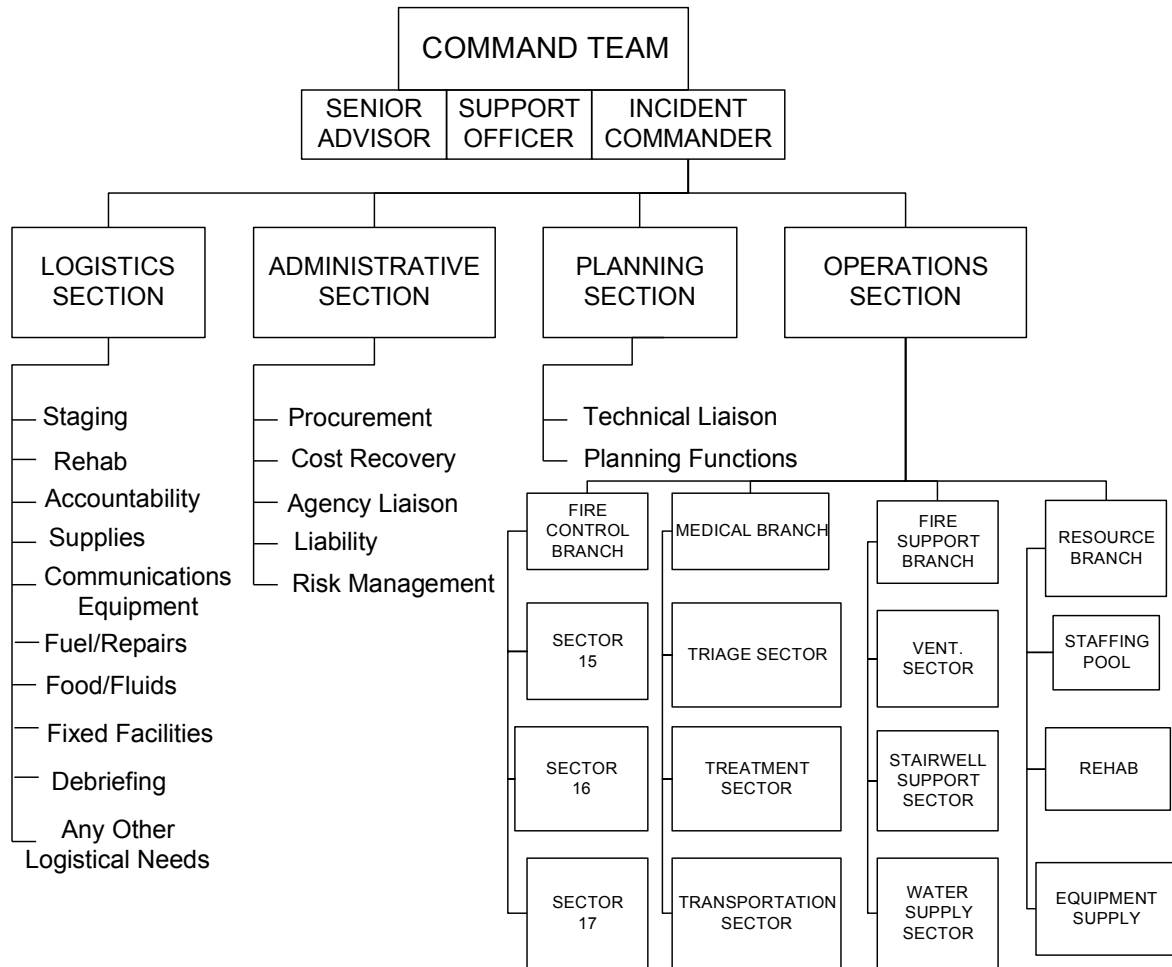

**Organizational Chart for a
Highrise Fire**

Expanding the Organization -- Major Incident

**PHOENIX REGIONAL
STANDARD OPERATING PROCEDURES**

IN-TRANSIT, ON-DECK, COMPANY RECYCLE

M.P. 201.01A

05/21-R

Page 1 of 4

The purpose of this procedure is to establish a standard deployment approach to communicating company arrival to assigned work areas, to define On-Deck deployment and Company Recycling.

IN-TRANSIT

In Transit is the time it takes for a company to reach their assignment area after receiving an order. It often varies due to:

- Distance between staging and the incident
- Size of the incident perimeter
- Amount of equipment the company needs to assemble

The Incident Commander (IC) or Sector Officer will lose direct accountability of these companies while they're In Transit. It is the responsibility of the Company Officer to monitor the tactical radio channel while In Transit. Upon arrival to the assignment area the Company Officer must provide a radio announcement to the IC (i.e., E-1 On Deck in North Sector) or report face-to-face with the Sector Officer that the company is intact and in the assigned area.

ON-DECK

On-Deck is defined as a tactical function within a Sector for layering of resources in forward positions. On-Deck is not an independent forward staging location. On-Deck companies should be located just outside the immediate hazard zone, safely distanced from the entrance of a tactical position/Sector. On-Deck crews will be supervised either by the Sector Officer or Company Officer of the On-Deck crew and will remain On-Deck until assigned by the IC or Sector Officer. The most likely assignments for On-Deck companies are:

- Rapid Intervention Crew
- Reinforce a position within an assigned sector
- Crew relief within an assigned sector
- Any other tactical position assigned by the IC

The IC should coordinate with the Sector Officers to provide effective resource levels in each Sector to manage the tactical objectives, work/rest cycles, as well as reserve or layered resources to respond to changes in conditions or a Mayday.

Once the IC has deployed units to the critical sectors around the incident scene, the IC must then take a proactive aggressive approach to assigning additional resources to those sectors. This is best achieved by assigning staged resources as On-Deck crews to those areas as soon as they arrive in staged positions. Layering On-Deck crews around the fireground will also provide the IC with the tactical reserves to manage the standard work cycle or sudden and unexpected events.

**PHOENIX REGIONAL
STANDARD OPERATING PROCEDURES**

IN-TRANSIT, ON-DECK, COMPANY RECYCLE

M.P. 201.01A

05/21-R

Page 2 of 4

Assigning On-Deck crews is done simply by contacting a staged company and directing them to go On-Deck in a specific Sector. The order would sound like this: "Command to Engine 5, go On-Deck on the north side of the structure, Engine 1 is your accountability location, you are assigned to North Sector."

A crew assigned to an On-Deck position will need to park their apparatus in a manner that doesn't block access to the scene. Crews must be intact with full PPE, forecast the need for and collect all the necessary tools/equipment (including the RIC Bag) and report directly to their assigned location. Upon arrival, the On-Deck company must contact the IC or their Sector Officer and inform them that they are in position and ready to go to work. On-Deck crews must remain intact, in a ready state and monitor the tactical channel at all times. On-Deck crews must also size up the area that they are assigned to, this size up should include:

- Locating the structures entrance/exit points in their assigned area
- Interior and exterior conditions
- Unit ID of crews operating inside the structure
- Approximate location of interior crews
- Identify which crews are operating each hose line

When an On-Deck crew is used as a relief crew, the Company Officer should do a face-to-face and transfer information with the Company Officer exiting the structure. The information transferred should include:

- Interior conditions
- Routing instructions to the work area
- Interior obstructions
- Additional tools/resources required
- Sector objectives

COMPANY RECYCLING

Recycling is defined as a timely and efficient means of air replacement and re-hydration of companies while maintaining their sector assignment. Recycling of Companies does not necessitate communication with the IC. The Sector Officer is responsible for the position and function of assigned companies, including companies that are recycling. Companies operating within a sector will require the refilling of air and fluid replacement in predictable time frames. If conditions permit, a company work cycle could be up to 2 to 3 air cylinders. To maintain a steady stream of resources in critical sectors, crews being relieved and exiting their sector should recycle themselves in a timely manner. Companies being relieved and recycled will remain in their assigned sector, follow established exposure reduction and decontamination guidelines, refill

**PHOENIX REGIONAL
STANDARD OPERATING PROCEDURES**

IN-TRANSIT, ON-DECK, COMPANY RECYCLE

M.P. 201.01A

05/21-R

Page 3 of 4

their air supply, and re-hydrate then report back to their Sector Officer or the IC that they are ready to go back to work.

Command/Sector Officers have the option of assigning/requesting a Utility Company to geographic sectors. Utility companies assigned to geographic areas on the fireground will help expedite the recycle of companies within the sector. Company Officers should forecast the length of time they will be working in an assigned sector and should bring spare air cylinders if necessary. This will enable a company to recycle close to their sector in a timely manner when a utility truck is not available in their sector or area. The Sector Officer may need to request additional resources to replace On-Deck crews or have recycled crews assume vacated On-Deck positions.

Sector and Company Officers are responsible to monitor the welfare of their personnel at all times and determine if sector recycling or a formal rehab is appropriate. At large scale incidents Command may establish Rehab Sector. Most of the time, crews that are assigned to rehab will be placed back in service after rehabbing. Rehab Sector may be located quite a distance from the work area and this distance creates the potential for:

- Command losing direct accountability of companies in transit to rehab
- Difficulty reassembling and reassigning crews in a timely manner from rehab

DIRECTION FOR ON-DECK COMPANIES

The Regional Operations Consistency Committee is charged with ensuring all Automatic Aid Partners act as one-entity for the purposes of emergency service delivery. When assigning On-Deck Companies, the IC may provide specific direction to those companies as needed. For example, the IC may:

- Direct the On-Deck Company to spot on a hydrant or lay a second supply line.
- Direct the On-Deck company to focus their efforts specifically on operating as a Rapid Intervention Crew for the assigned Sector. For example, "Command to Engine 273, go On-Deck for Rescue on the south side of the structure, Engine 207 is your accountability location, you are assigned to Interior Sector."

In the instance of any critical need, like treatment of a civilian victim rescued from the fire, the On-Deck company should be directed to initiate treatment. If this occurs, the IC will assign another fire company to go On-Deck for Rescue reporting to Interior Sector.

Note: Regional consistency is critical, especially in a Mayday situation. The best practice for regional consistency in a Mayday situation is for the IC to organize the incident in a consistent

**PHOENIX REGIONAL
STANDARD OPERATING PROCEDURES**

IN-TRANSIT, ON-DECK, COMPANY RECYCLE

M.P. 201.01A

05/21-R

Page 4 of 4

manner and for the Sector Officer to manage the resolution of the Mayday situation within their sector.

PHOENIX REGIONAL
STANDARD OPERATING PROCEDURES

Mayday Readiness and Response

M.P. 201.01B

01/14-N

Page 1 of 8

Definition of a Mayday Situation

Any situation where a firefighter is unable to safely exit the hazard zone or an event that cannot be resolved by that individual within 30 seconds

Any member working on duty is empowered to call a Mayday when the above conditions exist. This can be during response; onscene of any incident or any time when a member becomes in trouble and a portable radio is available. Early identification of a Mayday situation is critical. The longer it takes to declare a Mayday situation the less likely a successful resolution is possible.

A Mayday is initiated by any member communicating “Mayday, Mayday, Mayday” via portable radio. Ideally Tactical Radio Operators in the dispatch center will hear this transmission and initiate a response.

The Rule of Mayday Readiness

It is every individual firefighter’s responsibility to maintain a high level of Mayday readiness at all times. This includes everyday preparation and prevention as well as the practiced ability to communicate and respond to a Mayday scenario.

“Mayday” procedures and actions are perishable for all levels of an incident organization. The strategic, tactical and task levels of hazard zone management should consistently and regularly be exercised for “Mayday” procedures and practices. This also includes the Dispatch/Tactical Radio component. The preparation should be developed into everyday activities and practiced at the company level.

Definition of Mayday Readiness

In order to reach a position of Mayday readiness, a firefighter must adopt an attitude and preparation to look at every incident from the standpoint of “what if I or another firefighter gets in trouble” prior to the development of a bad scenario or outcome. Additionally, the NFPA 1500 Standard defines mayday readiness as the ability to “don, doff and manipulate the SCBA in zero visibility while wearing firefighting gloves.”

Effectively preventing Mayday situations involve multiple factors. Command Officers, Company Officers and Firefighters must reinforce the prevention of scenarios that lead to a Mayday. The most important factors for Mayday prevention begin with the following operational standards:

- Working within an Incident Command System/Risk Management System
- Working within the Incident Action Plan
- Always being accountable to someone within the incident command system (**Never Freelance**)
- Maintaining individual and crew air management

PHOENIX REGIONAL
STANDARD OPERATING PROCEDURES

Mayday Readiness and Response

M.P. 201.01B

01/14-N

Page 2 of 8

- Management of work cycles
- Monitoring distances traveled into buildings
- Layering of resources and providing for a tactical reserve
- Planning and acting out an exit plan

In order to establish effective Mayday readiness, it is necessary to recognize that Mayday readiness has 2 components. These components are **Prevention and Response**.

Task Level Mayday Readiness and Response

Every firefighter has the responsibility to actively and routinely prepare for the prevention of Mayday situations and the response to Mayday situations.

Individual firefighter responsibilities for Mayday prevention include the following:

- Maintaining SCBA proficiency
- Practicing individual air management (task level of M.P. 202.05C)
- Use and care personal protective equipment
- Portable radio proficiency and use
- Practiced crew communications
- Roving/replacement firefighter integration into crew
 - Individual firefighters have to be responsible to ask if not initiated by Company Officer

The Company Officer is responsible for Crew development and practice. Consistent training and practice with regards to Mayday prevention is critical for rapid and appropriate response in a true Mayday situation. This involves setting a consistent attitude and expectations for all crew members regarding Mayday readiness. This also involves developing routines that are encouraged and participated in by the Company Officer.

Company Officer responsibility for Mayday preventions include:

- Integrating a daily SCBA check into the crew routine
- Practicing crew communication in the hazard zone
- Rover integration into crew
 - Individual rovers are responsible to ask if not explicitly discussed at the beginning of a shift
- Maintaining knowledge of portable radios and practicing their use
- Ensuring Company Officer responsibilities and expectations are clear to the entire crew
- Practicing and maintaining crew integrity/accountability
- Instilling the standard that firefighters should always stay on a hoseline

PHOENIX REGIONAL
STANDARD OPERATING PROCEDURES

Mayday Readiness and Response

M.P. 201.01B

01/14-N

Page 3 of 8

The individual firefighter's response to a Mayday situation should be focused on increasing the chances of survival. The development of these skills truly begins at the Recruit level and should continue throughout a firefighter's career on a daily basis. The response to an individual firefighter's Mayday should initially be managed at the company level and as the Mayday communication happens this will initiate the defined help order.

Individual firefighter responsibilities for Mayday response include:

- Maintaining preparation and reaction skills
- Early communication of Mayday situation utilizing the above standard
- Controlling an emotional response to the situation
- Once the Mayday situation is recognized and reported, each firefighter should remember:
 - B.O.A. = Breath, Organize and Act
- Utilization of IAFF Fire Ground Survival training
 - SCBA familiarization
 - High/low profile wall breach
 - Disentanglement
 - Ladder bail
 - Window hang
 - GRAB LIVES
 - G = Check Air Gauge
 - R = Radio for Assistance
 - A = Activate PASS Device
 - B = Control Breathing, Conserve Air
 - L = Stay Low
 - I = Illuminate, Turn Flashlight On
 - V = Make Loud Noises (Volume)
 - E = Find An Exit
 - S = Shield Your Airway (last ditch effort)

Tactical Level Mayday Readiness and Response

The tactical level of every incident has the responsibility to actively and routinely work toward Mayday prevention and preparedness. The Battalion Chief and F.I.T. or I.S.O. tandem best manages these responsibilities. These responsibilities include:

- Working within the overall incident action plan
- Continual assessment of the decision making model within the sector operations
- Management of tactical objectives for the sector through position and functions of crews working within this sector

PHOENIX REGIONAL
STANDARD OPERATING PROCEDURES

Mayday Readiness and Response

M.P. 201.01B

01/14-N

Page 4 of 8

- Sector level air management
 - Managing geographic working area
 - Work/rest cycles
 - Distances into building
- Accountability
 - Maintain adequate resources assigned to the sector (remember to TAG hose lines)
 - Layered resources in position to manage tactical objectives and prepared to respond in the event of Mayday
- Maintaining effective and appropriate communications with Command
 - Sector C.A.N. reports
 - Requesting or de-committing resources

In the event of a Mayday situation, the Sector Officer will take responsibility of the resolution of the Mayday situation. It will be necessary for the Incident Commander to support the Mayday Sector Officer with appropriate and adequate resources to manage the Mayday at the same time reinforcing the surrounding geographical and/or functional sectors to continue the incident mitigation. Pessimistically projecting resource requirements for sector operations has the potential to increase the survivability of a Mayday situation. Other responsibilities include:

- Responding to the Mayday from the inside out
- Manage communications with the down firefighter
- Manage the search and rescue efforts for the down firefighter if necessary
- Increase and maintain resources assigned to the sector
 - Manage the logistical support as well
- Improve survivability and tenability
 - Increase exterior access to sector
 - Utilize RIC bag
 - Request additional if necessary
 - Improve ventilation
- Recognize and support the help order of a Mayday
 - Self-rescue by the Mayday initiator
 - Down firefighter's crew
 - Crews working in the same sector
 - Crews with firefighting assignments
 - Crews from and "on-deck" position or staged outside of the sector as a tactical reserve
 - Additional resources requested from the Incident Commander
 - Crews from other sectors
 - Requesting additional staged resources
 - Communications with surrounding geographical or functional sectors

PHOENIX REGIONAL
STANDARD OPERATING PROCEDURES

Mayday Readiness and Response

M.P. 201.01B

01/14-N

Page 5 of 8

- Surrounding sectors, not involved in the Mayday
 - Continue the firefight in support of the Mayday
 - Actively account for all members assigned to sector
 - Report P.A.R.'s to Incident Commander as required
- Maintain accountability of crews working to resolve the Mayday
 - Utilizing the Safety Channel may be the best route of communications to the Command Van regarding accountability
- **Maintain awareness of fire and smoke conditions, as well as building conditions, as rescue efforts are initiated**
 - **There is no greater time for a clear and concise utilization of the Risk Management System than during a Mayday event**
 - **It is not acceptable to create further Mayday situations when resolving an existing Mayday**
 - **These conditions must be communicated to the Incident Commander especially as conditions deteriorate and have an immediate impact upon the rescue efforts**

Strategic Level Mayday Readiness and Response

The Incident Command Team has the ultimate responsibility for actively and continually providing for the prevention and response to a Mayday situation. The incident command team consists of the Incident Commander, Support Officer and the Senior Advisor. There are other positions and personnel that will provide support when working within a Command Van including the staging radio channel, logistics and safety.

The responsibilities for the Strategic Level of an incident for the prevention and response to a Mayday include:

- Continually reassess the incident through the strategic decision making model
 - Critical fireground factors
 - Considering elapsed time into the incident
 - Risk Management position
 - Strategy
 - Evaluation of the incident action plan (is there a plan B?)
 - Resources
 - Consider remaining onscene firefighters welfare
 - Plan and prepare for communications challenges
 - Mayday initiated on wrong radio channel
 - Multiple, simultaneous Maydays

PHOENIX REGIONAL
STANDARD OPERATING PROCEDURES

Mayday Readiness and Response

M.P. 201.01B

01/14-N

Page 6 of 8

- Strategic level communications
 - Control incident communications
 - Once an Mayday is initiated, all sectors should manage their communications to critical messages only over the radio
 - No news in good news
 - Manage communications pace and tone
 - Incident and Mayday always remain on the same tactical channel
 - Accountability
 - Tactical benchmarks
 - C.A.N. and P.A.R. reports requests to Sectors as needed
- Continuing strategic level continuity
 - Manage and support the Mayday at the strategic level
 - Ensure Battalion Chiefs are assigned to all critical tactical level positions
 - Firefighting sectors (geographical and/or functional)
 - Medical sectors
 - Transportation sectors
 - Continue to manage remaining firefight
 - **Ensure the overall incident actions match the overall incident conditions**
 - Maintain the overall incident organization
 - Provide for tactical level accountability
 - Manage resource deployment
 - Control access to the hazard zone through the Sector Officers
 - Support tactical level considerations
 - Improve access to building
 - Support with ventilation
 - Continue to address the fire when conditions will allow
- Communicate progress appropriately to the policy and political levels of city government

The tactical benchmark for the end point of a Mayday is “Mayday resolved”. The critical points that have to be confirmed prior to giving the benchmark of “Mayday resolved” is:

- The individual(s) that are experiencing the Mayday situation are removed from the hazard zone
- All members involved in the rescue are accounted for and are out of the hazard zone
- All members working in all other sectors are accounted for
- The Incident Commander can give a PAR for the entire hazard zone

PHOENIX REGIONAL
STANDARD OPERATING PROCEDURES

Mayday Readiness and Response

M.P. 201.01B

01/14-N

Page 7 of 8

The Officer of the individual sector in which the Mayday occurred has the responsibility to notify command of the completion of the rescue and that all members involved are out of the hazard zone. The Incident Commander has the obligation to complete the accountability process for the entire incident and complete the benchmark “Mayday resolved”.

Dispatch Center Responsibilities

It is critical to acknowledge the role the dispatch center and most specifically the tactical radio operators will have in the resolution of a Mayday. A significant component of the overall hazard zone management system and firefighter safety is the contact between the incident command team and the dispatch center, no matter the incident size. The tactical radio operator responsibilities for a Mayday response are as follows:

- A Mayday is initiated by a member in the field communicating “Mayday, Mayday, Mayday” on the radio
- A Mayday can be initiated by anyone, at anytime working in the field and has access to a portable radio
- Mayday is not just a fireground term, it can be used in any hazard zone
- Upon initiation of a Mayday, the tactical radio operator shall:
 - Transmit the emergency traffic tone
 - Voice on the tactical channel: “We have a Mayday on the scene, all units hold your traffic”
 - Repeats the Mayday message using the standard radio order model
 - Allows for the Incident Commander to speak to the Mayday initiator
- If the first Fire Department Company onscene of a fire incident initiates the Mayday, the tactical radio operator shall:
 - Assures the member that “help is on the way”
 - Maintains communications with the Mayday initiator until other units arrive
 - Ensure the communications are necessary and not to fill dead radio time
 - Reminds the member to initiate their “GRAB LIVES” procedures
 - Ensures all responding units are aware of the Mayday
 - Upgrades the assignment to a Mayday nature code
- The entire dispatch center provides redundant monitoring of the Mayday radio traffic
- The dispatch center provides some automatic activation of processes to assist with a Mayday incident. These include:
 - Additional resources
 - Upon the initiation of a Mayday, the incident is upgraded using the Mayday nature code
 - If 3 – 1 incident, then balanced to 1st Alarm Mayday
 - If 1st Alarm incident, then balanced to 2nd Alarm Mayday
 - Continues to 9 Alarms
 - Provide additional medical or transport resources as appropriate
 - Monitoring of all *possible* hazard zone channels

PHOENIX REGIONAL
STANDARD OPERATING PROCEDURES

Mayday Readiness and Response

M.P. 201.01B

01/14-N

Page 8 of 8

Conclusion

- It is every firefighters responsibility to maintain their preparedness for a Mayday situation
- The only way to guarantee a successful outcome of a Mayday situation is to **PREVENT IT!**
- Mayday prevention and preparedness requires action at all levels of an incident command system
- The Ultimate goal for any Mayday response is to successfully resolve the Mayday and at the same time not create any further Mayday situations
- Any Mayday situation elevates the emotional levels and will test a command system.
- All members, at all levels of the incident involving a Mayday should remember **B.O.A.**

Breathe, Organize and Act!

**PHOENIX REGIONAL
STANDARD OPERATING PROCEDURES**

Risk Management and Safety

M.P. 201.01C

01/18

Page 1 of 2

Purpose

Operating at emergency incidents poses an inherent risk of injury – or worse, death. The purpose of this procedure is to describe the Regional Operating Procedure regarding risk assessment and safety management of emergency incidents. We are committed to providing the safest possible work environment for our members. It is important that all members operating at incidents operate in a safe manner. Each member is responsible for their own safety and to work within the incident action plan to maintain effective accountability and effective coordination of action. Towards that goal, all members are expected to operate under the following Risk Management Plan.

Procedure

All operating personnel shall work within a standard Risk Management Plan during all emergency operations on every emergency incident. This application will be continuously re-assessed at all levels of the incident until all units leave the scene.

1. We Will risk our lives a lot, in a calculated manner, to save savable lives.
2. We Will risk our lives a Little, in a calculated manner, to save savable property.
3. We Will Not risk our lives at all for lives or property that are already Lost.

“Actions in a calculated manner” require the following:

- Continual use of the Strategic Decision Making Model
- Incident Command established
- Proper personal protective equipment
- Accountability system established
- Safety procedures in place
- Continuous risk assessment by all members
- Uninterrupted Communications

Operational Information

The position in the risk management plan represents the “why” are we taking risk at this incident. It must be clear to all companies, working at all levels of the incident command system, that the incident strategy and plans are focused on either savable lives or savable

**PHOENIX REGIONAL
STANDARD OPERATING PROCEDURES**

Risk Management and Safety

M.P. 201.01C

01/18

Page 2 of 2

property. The recognition through an effective size-up that savable lives may be present at an incident and that the conditions exist that the fire crews can provide a rescue is a situation that has the greatest allowable threshold for risk. The questions that are necessary to determine this level of risk are:

- Is it reasonable to believe that there are savable lives present at this incident?
- Are there any survivable environments or compartments at this incident?
- Do we have the resources and ability to affect a rescue and survive to complete it?

For fire incidents, a quick and overwhelming attack on the fire, from any reasonable position, may be the best thing for mitigating significant risk and allowing the opportunity for rescue and firefighter survivability.

If the incident size-up has determined neither, savable lives or savable property are present because of the conditions, no or very limited risk shall be taken within a defensive strategy.

This risk management plan is effective and necessary for all types of hazards and incidents. This includes:

- Large scale medical incidents
- Hazardous materials incidents
- Technical rescue incidents
- Violent incidents

PHOENIX REGIONAL STANDARD OPERATING PROCEDURES	
Policy Name: FIRE BEHAVIOR GLOSSARY & REFERENCE	Policy Number: M.P. 201.01D
This policy is for internal use only and is not intended, nor should it be construed to expand the legal duty under the law or expand civil liability in any way. This policy does not create a higher duty of care under the law to act. Remedies for violations of this policy, if proven, are limited to administrative disciplinary action against PFD employees.	
Related Policies:	
Other Reference:	
Date Implemented: 1/2022-N	Review Date: 1/2028

The purpose of the procedures is to ensure the fundamental knowledge and understanding of fire behavior and fire dynamics. This knowledge is pivotal to professional fire suppression and life safety protection services to our community. It is also a critical element in the safety and longevity of firefighters working to protect our community. Phoenix Firefighters, not only need to know the dangers of fire, but need to truly understand what fire is, how it develops, and how it reacts with our tactics. To carry out our mission of saving lives and property, we must have an in depth understanding of fire behavior and fire dynamics.

This procedure is meant to be a glossary of fire science and fire behavior terms as well as reference tool for fire suppression fundamentals and tactics.

[UL-FSRI: *Your Workplace Has Changed: You Need to Evolve*](#)

[UL-FSRI: *There is No Substitute for Knowledge*](#)

CHEMISTRY OF FIRE

Fire: The term “fire” refers to how something burns. Fire is a rapid oxidation process, which is a chemical reaction resulting in the evolution of light and heat in varying intensities.

Combustion: Combustion is a chemical process of oxidation that occurs at a rate fast enough to produce heat and *usually* light in the form of either a glow or flame.

Modes of Combustion: Fire and combustion are similar conditions; however, combustion can occur without fire.

There are two modes of combustion, non-flaming and flaming.

Non-Flaming Combustion: Non-flaming combustion occurs more slowly and at a lower temperature producing a smoldering glow in the material's surface without flames.

Flaming Combustion: Flaming combustion is commonly referred to as fire because it produces a visible flame above the material's surface.

Fire Models: Two models, the fire triangle and fire tetrahedron are used to explain the elements of fire and how fires can be extinguished.

Fire Triangle: The oldest and simplest model, the fire triangle, illustrates the three elements necessary for combustion to occur: fuel, oxygen and heat. Remove any one of these elements and combustion will cease. The fire triangle best illustrates the elements required for *non-flaming* combustion; when burning is localized on or near the fuel's surface where it is in contact with oxygen. Examples of non-flaming combustion include burning charcoal briquettes or smoldering wood or fabric.

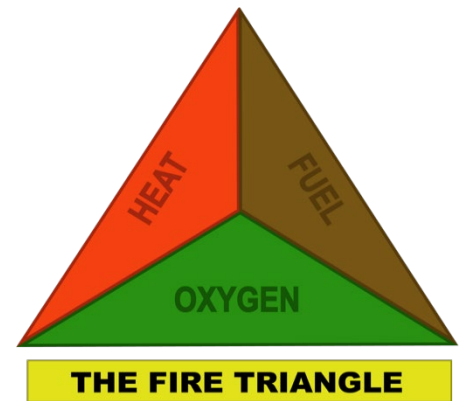

Fire Tetrahedron: Research into fire behavior has determined that an uninhibited chemical chain reaction must also be present in addition to the other elements of the fire triangle (fuel, oxygen & heat) in order for flames to occur. Therefore, the fire tetrahedron was created to explain *flaming* combustion. Each element of the fire tetrahedron; fuel, oxygen, heat & uninhibited chemical chain reaction must be present for flaming combustion. Removing any element of the tetrahedron interrupts the chemical chain reaction and stops flaming combustion.

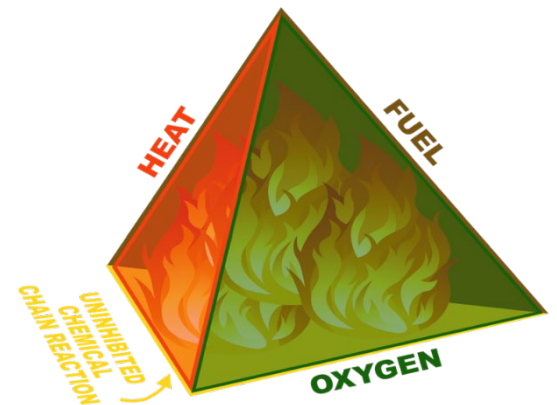

Fuel: Fuel may be found in any of three states of matter: solid, liquid, or gas. Only gases burn. For a solid or liquid to burn, they must be converted into a gas. Solids are converted into gas by **pyrolysis** and Liquids are converted to a gas by **vaporization**.

Pyrolysis: Pyrolysis is the chemical decomposition of a solid material that is caused by the absorption of heat. When pyrolysis of a material occurs, gas is released from the solid material. Pyrolysis often precedes combustion.



Surface to Mass Ratio: significantly affects the ease of ignition of solid fuels.

Vaporization: Liquids are converted into gas by vaporization. Examples of vaporization include boiling water or water in a container evaporating in sunlight. In both cases, heat causes the liquid to vaporize.

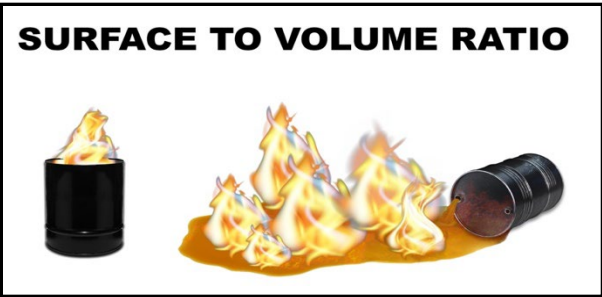

Heat Energy: The transfer or flow due to the difference in temperature between two objects is called heat. Heat energy is a form of energy characterized by vibration of molecules and capable of initiating and supporting chemical changes and changes of state. In other words, it is the energy needed to change temperature of an object(s) – add heat, temperature increases; remove heat, temperature decreases.

Temperature: Temperature is a measure of the degree of molecular activity of a material compared to a reference point. Temperature is measured in degrees Fahrenheit or degrees Celsius.

Heat Release Rate: Heat release rate (HRR) is the rate at which fire releases energy – this is also known as power. HRR is measured in units of Watts (W), which is an International System unit equal to one Joule per second.

Temperature vs Heat Release Rate: One candle vs ten candles – same flame temperature but 10 times the heat release rate (see below). Both examples are producing 930° F - 2500° F in temperature. The single candle is producing ~ 80 W HRR. The ten candles are producing ~800 W HRR.

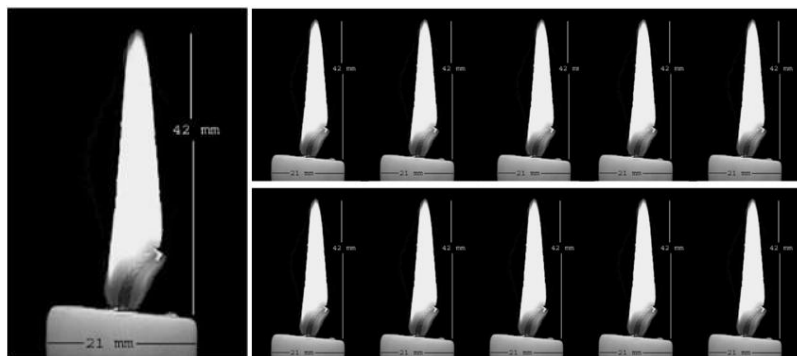

[UL-FSRI: Understanding the Basics: Heat Release Rate vs Temperature](#)

Surface to Volume Ratio: Surface to volume ration significantly affects the ease of ignition of liquid fuels. The greater the surface area compared to volume, the faster the liquid will vaporize. An example of this is a gallon of gasoline within a small steel container sitting on the floor in the

middle of a room (smaller surface area) or a gallon of gasoline spilled out on a floor all over the room (larger surface area). The fire in the container will not produce the same volume of fire as the floor that is covered in gasoline.

Gaseous fuels can be the most dangerous because they are already in the natural state required for ignition. No pyrolysis or vaporization will be needed to ready the fuel. These fuels are also the most difficult to contain.

Oxygen: Oxygen in the air is the primary oxidizing agent in most fires. Normally, air consists of 20.8% oxygen. At normal ambient temperatures, materials can ignite and burn at oxygen concentrations as low as **15 percent**. When oxygen concentration is reduced below 15%, the flaming combustion will diminish, causing combustion to continue in the non-flaming mode. This means that below 15% there will not be visible flames, but because combustion continues in the non-flaming mode, heat and dense, fuel rich smoke will continue to be produced. If oxygen is introduced to this type of atmosphere, the fuel rich environment can ignite and be hazardous to firefighters.

Some fires involve fuels that contain chemical oxidizers (their own oxygen source) such as Ammonium Nitrate Fertilizer and Hydrogen Peroxide. These compounds can cause rapid burning rates, flame spread and explosions when they breakdown and do not depend on oxygen in the air to burn.

When oxygen concentration is higher than 20.8%, materials exhibit very different burning characteristics. Materials that burn at normal oxygen levels will burn more intensely in oxygen-enriched atmospheres. Many materials that do not burn at all in normal oxygen levels, may burn readily in oxygen-enriched atmospheres. Nomex, a fire-resistant fabric used in our PPE does not burn readily in normal oxygen concentrations. When placed in an oxygen enriched atmosphere, Nomex ignites and burns vigorously. Some petroleum-based materials may ignite spontaneously without an external heat source in oxygen-enriched atmospheres.

HEAT TRANSFER: A number of natural laws of physics are involved in the transmission of heat. One is called the **Law of Heat Flow**; it specifies that heat *always* flows from a hot substance to a cold substance. The colder of two objects in contact with each other will absorb heat until both objects are at the same temperature.

Heat can travel throughout a building by one or more of three methods: conduction, convection, and radiation. The following sections describe how this heat transfer takes place.



CONDUCTION

CONVECTION

RADIATION

Conduction: Heat may be conducted from one body to another by direct contact of two objects or by an intervening heat-conducting medium (material). An example of this type of heat transfer is a cellar fire that heats pipes enough that the pipes ignite the wood inside walls remote from the fire. Another example is firefighters crawling on a hot floor that burn their knees.



CONDUCTION

Convection: Convection is the transfer of heat by the movement of air or liquid. When water is heated in a container, it expands and grows lighter, hence, the upward movement. Heated air in a building will expand (**creating pressure**) and rise. For this reason, fire spread by convection is mostly in an upward direction; however, air currents can carry heat in any direction. Convection currents are generally the cause of heat movement, from room to room, from floor to floor and from area to area. The spread of fire through corridors, up stairwells, and elevator shafts; between walls, and through attics is caused mostly by the convection of heat currents.

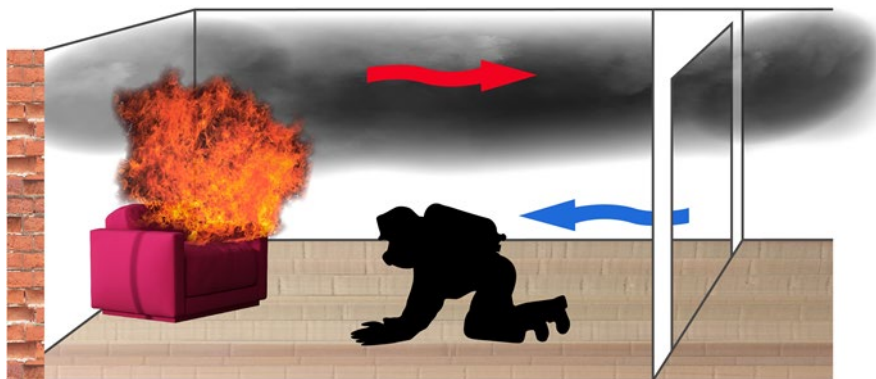

CONVECTION

Radiation: Radiation describes heat transfer through the movement of heat waves. Heat and light waves will cause radiated heat to travel through a space until it reaches an object.

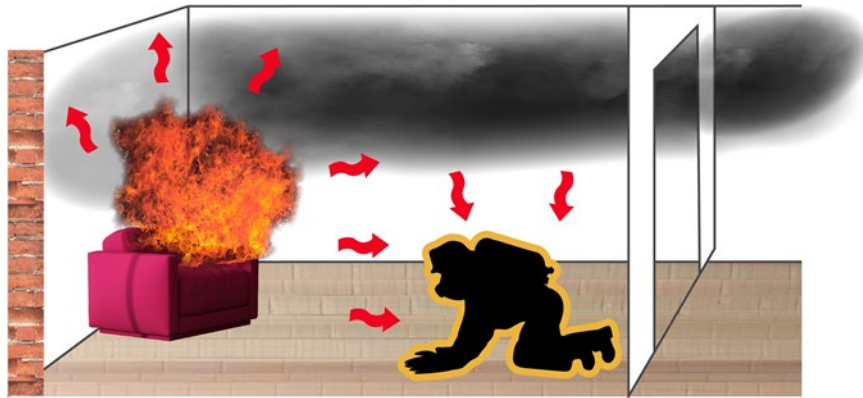

RADIATION

As the object is exposed to heat radiation, it will in return radiate heat from its surface. Radiated heat is one of the major sources of fire spread to exposures. Radiated heat is also one of the major causes of firefighter burn injuries and flashover in a compartment fire.

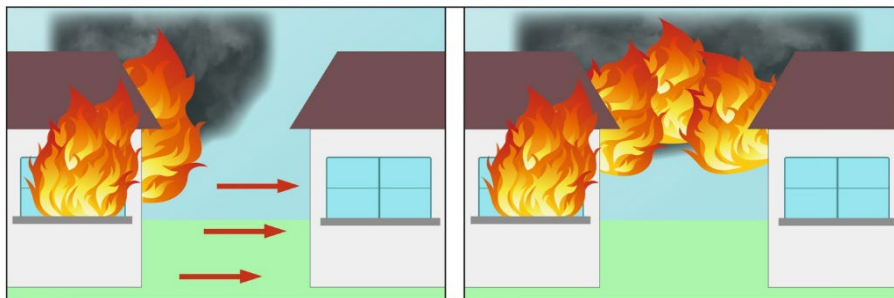

[UL-FSRI Understanding How Heat Transfers Through Turnout Gear](#)

Uninhibited Chemical Chain Reaction: The last part of the Fire Tetrahedron is the self-sustained uninhibited chemical chain reaction involved in flaming combustion. Understand that a chemical chain reaction occurs when fuels are broken down by heat and the reaction will cause the fire to continue to burn until the fuel or oxygen is exhausted, or an extinguishing agent is applied in sufficient quantity to interfere with the ongoing reaction.

Extinguishment Theory: The extinguishment of fire is carried out by limiting or removing one or more of the essential elements in the combustion process (removing one of the sides of the fire

triangle or tetrahedron). This is accomplished by one of four methods: heat reduction, fuel removal, oxygen removal or chemical flame inhibition.

Heat Reduction: The most common method used to accomplish extinguishment is the application of water. This process of extinguishment is dependent on reducing the temperature of the fuel to a point where it does not produce sufficient vapor to burn.

REDUCTION OF TEMPERATURE



Fuel Removal: In some cases, a fire is effectively extinguished by removing the fuel source. Removal of the fuel source may be accomplished by stopping the flow of liquid or gaseous fuel or by removing solid fuel in the path of the fire. Another method of fuel removal is to allow the fire to burn until the fuel is consumed.

Extinguishment by Oxygen Reduction: Reducing the oxygen content in an area also extinguishes the fire. Reduction of the oxygen content can be accomplished by flooding an area with an inert gas, such as carbon dioxide, which displaces the oxygen; or the oxygen can be reduced by separating the fuel from the air such as by blanketing it with foam or placing a cover on a pot. None of these methods work on those rare fuels that are self-oxidizing.





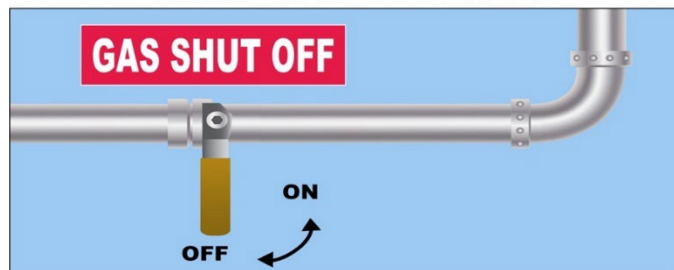

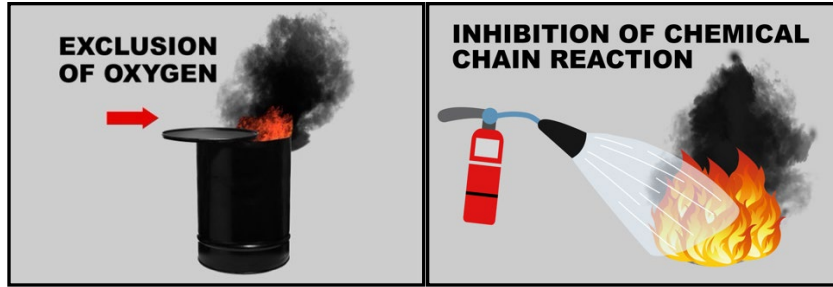



Extinguishment by Chemical Flame Inhibition: Some extinguishing agents, such as dry chemical (sodium bicarbonate) and older systems such as Halon (halogenated hydrocarbons), interrupt the flame-producing chemical reaction and stop flaming. This method of extinguishment is effective on gas and liquid fuels, because they must flame to burn. Smoldering fires are not easily extinguished by this method because non-flaming combustion (represented by the fire triangle) does not require the presence of the chemical chain reaction present in flaming combustion (represented by the fire tetrahedron). Cooling is the preferred way to extinguish a smoldering fire.

REMOVAL OF FUEL





Classes of Fires

CLASS OF FIRE	TYPE OF FIRE	SUITABLE SUPPRESSION	NFPA CLASS	SYMBOL
A	COMMON COMBUSTIBLES wood, paper, cloth, rubber, and many plastics	Water Dry Chem Foam		
B	FLAMMABLE LIQUIDS AND GASES gasoline, oils, paint, lacquer, and tar	Dry Chem Carbon Dioxide Foam		
C	ENERGIZED ELECTRICAL EQUIPMENT computers, computers, servers, transformers, and appliances	Purple K Dry Chem Carbon Dioxide		
D	COMBUSTIBLE METALS magnesium, lithium, aluminum, titanium	Class D Powder		
K	COOKING OILS AND FATS vegetable or animal oils and fats	Wet Chemical Carbon Dioxide Foam		

Solid Fuel Combustion: As solid fuels are exposed to heat, they absorb energy and increase in temperature. As the temperature of the solid rises, the solid fuel begins to decompose and break down. When it breaks down, it releases gas. Solid fuel when exposed to enough heat, will transform into a gas. The gas ignites and produces fire during flaming combustion.

Pyrolysis: The chemical decomposition of a solid material that is caused by the absorption of heat. When pyrolysis of a material occurs, gas is released from the solid material. Pyrolysis often precedes combustion.

Liquid Fuel Combustion: For liquid fuels to burn, they must release vapors and those vapors must mix with air so that the concentration of fuel is within the explosive/flammable range. A liquid fuel with a higher vapor pressure generates more fuel vapor than a liquid fuel with a lower vapor pressure. If heat is added to a fuel vapor, once the fuel concentration is within the explosive/flammable range, it is possible for it to ignite. A fire may then begin and grow wherever a flammable mixture is present.

Flash Point: The lowest temperature of a liquid at which that liquid gives off sufficient vapors to ignite but will not continue to burn. Liquid fuels are classified according to their fire hazard characteristics. The classifications are based on the flash point of the liquid. Depending on the flash point temperature, liquids are grouped as to whether they are flammable (more of a hazard) or combustible liquids (less of a hazard).

Flammable Liquid: A flammable liquid is a liquid that has a flash point below 100°F

Combustible Liquid: A combustible liquid is a liquid that has a flash point equal to or greater than 100°F.

Fire Point: Fire point is the lowest temperature at which a liquid will ignite and achieve sustained burning.

Vapor Pressure: Vapor pressure is the ability of a liquid or solid fuel to vaporize. The higher the vapor pressure, the more vapors are released (the easier it is to off-gas).

Vapor Density: The vapor density of gas refers to its density compared to air. Gases that have a vapor density around 1 will mix evenly with air. A gas with a vapor density greater than 1 is heavier than air. It will sink and collect in low areas. Gases that have vapor densities less than 1 are lighter than air and will rise to the top of a compartment.

Gaseous Fuel Combustion: In a fire, oxygen must chemically react with combustible fuel in a rapid oxidation process. For flaming combustion to begin and continue, the concentration of fuel vapor in the burning mixture (air and fuel) must be between the upper and lower explosive limits for that fuel. When the concentration of fuel in the air lies between the lower explosive limit (LEL) and the upper explosive limit (UEL), there is danger of the fuel igniting if a flame or other ignition source is present.

Lower Explosive Limit (LEL): The lower explosive limit is the lowest concentration by volume of flammable gas in air that will support flame propagation. This is also known as lower flammability limit.

Upper Explosive Limit (UEL): The upper explosive limit is the highest concentration by volume of flammable gas in air that will support flame propagation. This is also known as upper flammability limit.

Explosive Range (aka Flammable Range): The range of gas to air mixtures in which ignition can occur. It is the range of gas to air mixture that exists between the lower explosive limit and the upper explosive limit.

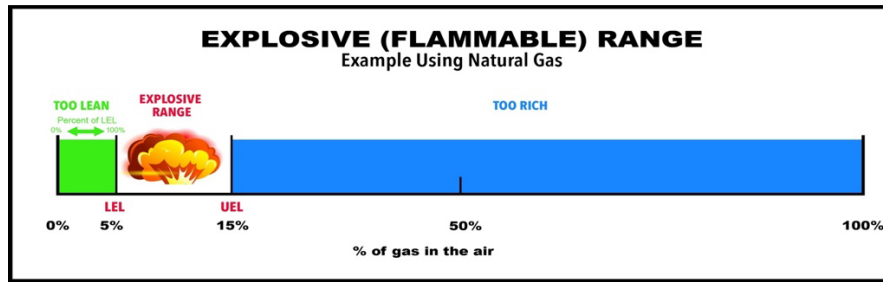

Compartment Fire Development: To help understand fire behavior, the development of a fire in a compartment (room/enclosure etc.) has been broken down into 4 different stages:

- Incipient Stage
- Growth Stage
- Fully Developed Stage
- Decay Stage

In each of these stages, the fire will have discernable characteristics (different fire conditions) which are used to identify the stage the fire is in. Since certain fire phenomenon are likely to occur during certain stages of fire development, a

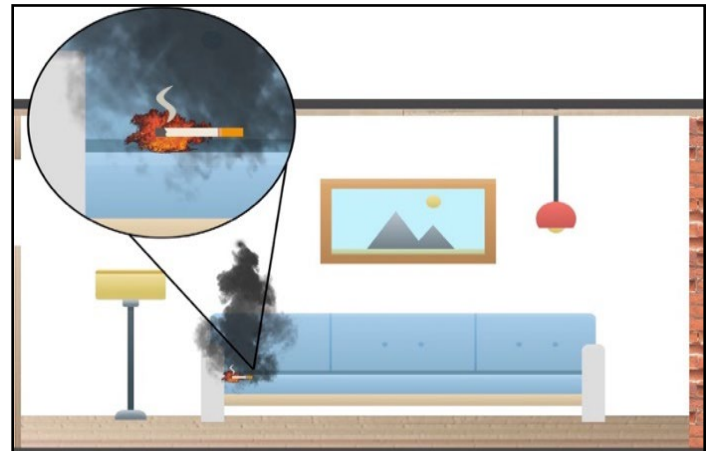

firefighter's understanding and ability to identify these stages will help the firefighter better size up fire conditions and make better tactical decisions on the fireground. It is important to note that while most fires will pass through all 4 stages, some fires may not, e.g.: An arson fire may begin in the growth stage. In addition, some fires may pass through some stages more than one time. E.g.: A fire in the decay stage may redevelop into the growth stage following ventilation.

Incipient Stage: The incipient stage is the earliest stage of a fire and begins with the actual ignition. The fire is generally small during this stage and burning is usually limited to the original materials of ignition. During this stage of fire development, radiant heat warms the adjacent fuels and continues the process of pyrolysis, increasing the volume of fire. A plume of hot gasses and flame rise from the fire and mixes with the cooler air in the room. As this plume reaches the ceiling, hot gasses begin to spread horizontally across the ceiling.

In the incipient stage, there is plenty of oxygen and fuel available to burn. Oxygen levels in the air have not been significantly reduced by the fire. Some heat is being generated but the temperature in the room may only slightly increase. **Incipient fires can be readily extinguished with the use of the proper fire extinguisher.** It is essential to recognize that the transition from an incipient fire into the growth stage can occur quickly (sometimes in seconds) depending on the type and configuration of fuel involved.

Growth Stage: The growth stage covers a wide spectrum of fire development. It is the period that usually begins when the original fire spreads to additional materials. As the fire grows, it may spread to other objects by any combination of heat transfer (conduction, convection or radiation), by direct flame impingement, or if foams or plastic materials are involved, they can melt, and drip liquid which is on fire. This burning liquid can pool on the floor while burning and ignite secondary items.

Similar to the incipient stage, during the growth stage there is plenty of oxygen and fuel available to burn. During the very beginning of this stage, oxygen levels in the room may not have been significantly reduced by the fire. Oxygen rich air will be drawn into the flame as convection carries the heat to the uppermost regions of the confined area.



The presence of this heated air will cause the temperature to begin to rise in the area and if left unchecked, may start a series of events that will lead to rapid fire development and flame spread. **Rollover** and **flashover** occur during the Growth Stage.



Fully Developed Stage (Full Room Involvement): After a compartment fire has flashed over, the fire *that remains within the compartment* which has flashed over is considered to be in the fully developed stage. The burning fuels in the compartment are releasing the maximum amount of heat possible for the available fuel and/or oxygen, producing large volumes of fire gases. These gases may travel throughout the building and into building voids while mixed into heavy smoke. The larger the volume of fire and larger the volume of smoke produced; the larger the impact on survivability will be, even in remote areas of the building.



Flammable products of combustion are likely to flow from the fire room into adjacent rooms or out through openings to the exterior of the building. Flames will extend out of the compartment openings because there is insufficient oxygen for complete combustion within the compartment itself.

Note: The fire is only fully developed within the compartment(s) that has flashed over. Fire spreading out of this compartment into other compartments or rooms may be in the growth stage and subject to additional rollover and flashover conditions.

Decay Stage (Fuel Limited or Ventilation Limited): A fire enters the decay stage when all of the available fuel is consumed or when the oxygen concentration falls below 15% and flaming combustion is diminished. Both of these situations can result in the combustion reaction coming to a stop and the fire being completely extinguished if fuel or oxygen is never introduced. However, if a fire enters the decay stage due to reduced oxygen concentration, which is very common in the modern fire environment, any change in the ventilation of the compartment that adds oxygen before combustion has completely ceased, can cause the fire to rapidly redevelop. It is important to note that the cause for any fire to enter the decay stage is because the fire is either *fuel limited* or *ventilation limited*.

Fuel Limited: If there is adequate ventilation and the fire consumes the available fuel in the compartment to the point that the heat release rate begins to decline, the fire enters the decay stage. This is because whatever fuel was burning has been entirely consumed and there is no additional fuel to burn. The fire has become fuel controlled.

Ventilation Limited: If there is adequate fuel available and the fire consumes enough of the available oxygen in the compartment, the heat release rate will also begin to decline, and the fire will enter the decay stage because the flames do not have enough oxygen. There is still plenty of fuel that is available to burn, and the fuel, even while it is smoldering, is pyrolyzing and emitting a large volume of flammable gases into the compartment. In this situation, if no oxygen is introduced, after a lengthy time, combustion will cease and the fire will be completely extinguished. However, if oxygen is introduced before combustion has ceased, rapid fire development and/or backdraft may result.

[UL-FSRI: Fire Development Changes When a Fire Becomes Ventilation Limited](#)

THERMAL LAYERING

Thermal Layering: The thermal layering of gases is the tendency of gases to form into layers according to temperature. The hottest gases tend to be near the top of the layering, while the cooler ones make up the bottom. Other terms that are sometimes used to describe this layering of gases are “heat stratification” and “thermal balance”.



Thermal layering inside a compartment fire, is further broken down into two separate categories: The **upper layer** which is composed of the hot fire gases and the **lower layer** which is the cooler air below the hot fire gases. It is important to understand these terms for tactical reasons e.g. a thermal imaging camera can identify the thermal interface if the camera itself is positioned in the lower layer (cooler layer) looking at the upper layer (hot layer). A camera held in the hot layer will not be able to see the thermal interface.

Upper Layer: Buoyant smoke and gases collected by the ceiling and walls of an enclosure that begin to form a relatively uniform layer of heated smoke and gases throughout the upper area of a compartment.

As a fire develops in a compartment, over time, the hot rising smoke and fire gases spread across the ceiling and mushroom down into the room as they collect in a thick, relatively uniformed layer of hot gases throughout the upper layers of the enclosure.

Once the upper hot layer is formed, the additional flow of gases from the fire continues to collect along the ceiling forcing the upper layer to descend downward into the room as the fire heat release rate and upper layer temperatures increase.

Decreasing the heat of the fire within the enclosure will decrease the temperature and formation of hot gases that collect in the upper layer. If the heat is reduced, it can result in the contraction of gases in the upper layer. The contraction of upper layer gas volume will cause the upper layer to lift.

Directly decreasing the temperature of the upper layer (i.e., through the application of water) will also result in a contraction of the upper layer gas volume as a result of the hot smoke cooling. This can delay or prevent flashover.

Lower Layer: The lower layer is the zone beneath the upper layer which consists primarily of ambient air that is entrained into the fire.

The cooler lower layer consists of air, at temperature and humidity levels closer to ambient conditions, drawn in through ventilation openings in the enclosure. As the hot gases rise in the buoyant plume, the cooler air is pulled in towards the fire.

THERMAL INTERFACE AND INTERFACE HEIGHT

Thermal Interface: The boundary between the upper and lower layers which is represented by a sharp transition from the hot smoke in the upper layer to the cool ambient air of the lower layer is called the Thermal Interface.

Interface Height: The vertical distance from the floor of the enclosure to the thermal interface.

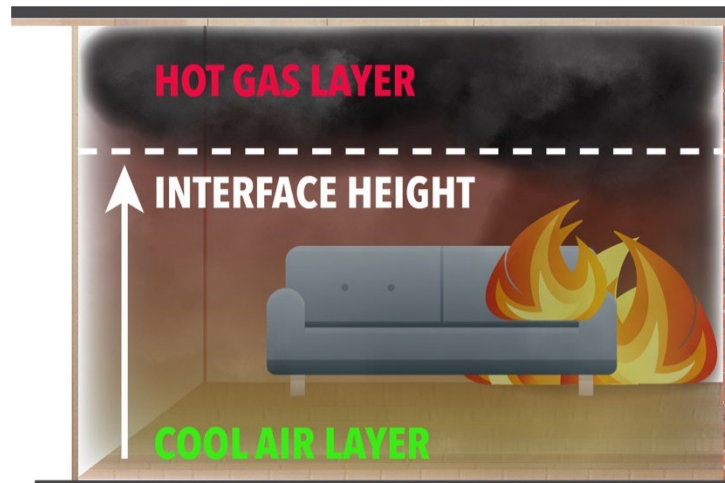

Neutral Plane: The flow of smoke and fire gases through an opening is described as either unidirectional or bidirectional. **Unidirectional flow** occurs when the flow through the opening flows in one direction only (either into or out of the opening). **Bidirectional flow** occurs when an opening acts as both an inlet and an outlet for flows at the same time.

UNI-DIRECTIONAL FLOWPATH

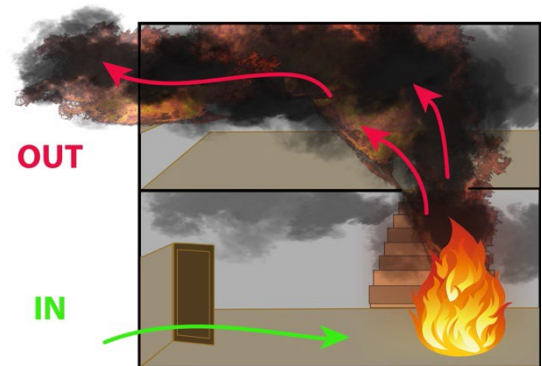

BI-DIRECTIONAL FLOWPATH



The horizontal line along a window or door or other ventilation opening where no flow occurs due to the equality of internal and external pressures. Above the neutral plane the flow of smoke and gases will be outwards and below the neutral plane the flow of cool air will be inwards.

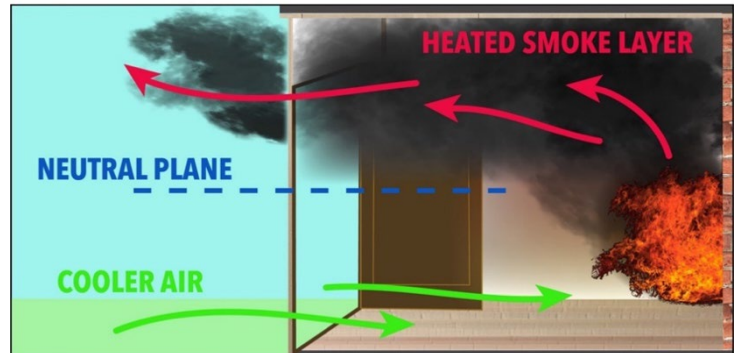
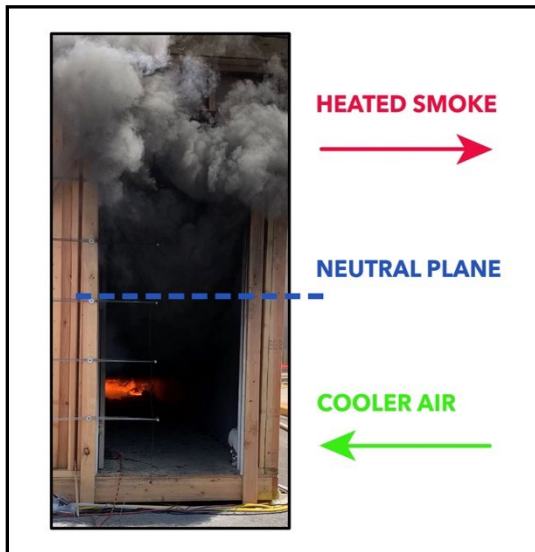

The volume of hot smoke generated by the fire largely determines the pressure distribution in the compartment under fire conditions. As the hot smoke rises and accumulates, the pressure at the ceiling will rise. Similarly, the pressure at the floor will be lower, as cool air is entrained. Above the neutral plane the pressure inside the enclosure will be higher than the exterior pressure and cause the direction of flow to be outward. Similarly, below the neutral plane the

pressure inside the enclosure will be less than the exterior pressure, and the flow of cool air will be inward toward the fire.

The horizontal line between the inflow and outflow at a ventilation opening (i.e., at the plane where there is zero pressure difference and thus zero flow in or out of the opening) is known as the neutral plane. The position of the neutral plane can often be observed during a fire, given that the outflow often consists of visible smoke or fire.

Note: The neutral plane is different from the thermal interface because the neutral plane only occurs at a ventilation opening. Neutral plane indicates **pressure differences** at an opening and may be used by firefighters outside the building to help determine the fire location within a building.

Thermal Interface and interface height refer to the separation between the hot upper layer and the cool lower layer within a compartment. Thermal Interface and the interface height indicate **heat differences** (how much volume of a compartment is filled with heat). It can be used by firefighters to identify how far the hot upper layer has banked down and the possibility of flashover.

SMOKE: The smoke encountered at most fires consists of a mixture of oxygen, nitrogen, carbon dioxide, carbon monoxide, hydrogen cyanide, finely divided carbon particles (soot), and a miscellaneous assortment of products that have been released from the material involved.

Two of the most toxic gases are **carbon monoxide** and **hydrogen cyanide** which are both chemical asphyxiants and are responsible for many fire deaths. These gases are highly toxic and pose a significant threat to human life.

The combination of fire gases produced during combustion and present in smoke are flammable and contribute greatly to rapid fire development. For this reason, firefighters shall consider smoke to be additional fuel.

When air is heated it becomes more buoyant (hot air rises). In addition to buoyancy, more than three-quarters of air is made up of nitrogen. The energy released by the fire causes the nitrogen to expand which drives a significant increase in the volume of the air.

The buoyancy of hot air and expansion of nitrogen can push significant volumes of smoke through openings to the exterior or to other parts of the structure. Because smoke is suspended in air, the smoke is a visible indicator of how much hot air is rising and how fast the nitrogen is expanding. The value of "reading smoke" is tremendous in performing a size up of the fire.

To accurately size up a fire by reading smoke, a firefighter must evaluate five characteristics of the smoke: Volume, Velocity, Density, Color and Stratification.

Smoke Volume: In many instances, smoke may be the only visible indicator of a fire. The volume of smoke may indicate the size, location and stage of the fire within a structure. However, the volume of smoke may not always be visible and can be concealed by various building configurations.

Smoke Velocity: Smoke velocity is an indicator of pressure that has built up within a structure. The pressure is developed by buoyancy and expansion due to the amount of heat released by the fire. Smoke flow can be either **laminar** (smooth) or **turbulent** based on the velocity and temperature. Cooler smoke appears to flow smoother. Hotter smoke will appear to boil and move quickly upwards in a turbulent fashion.

- A. Turbulent Smoke indicates extreme heat (closer to the fire)
- B. Laminar Smoke indicates low heat (either because it is a small fire, or the smoke is remote from the fire and has cooled)

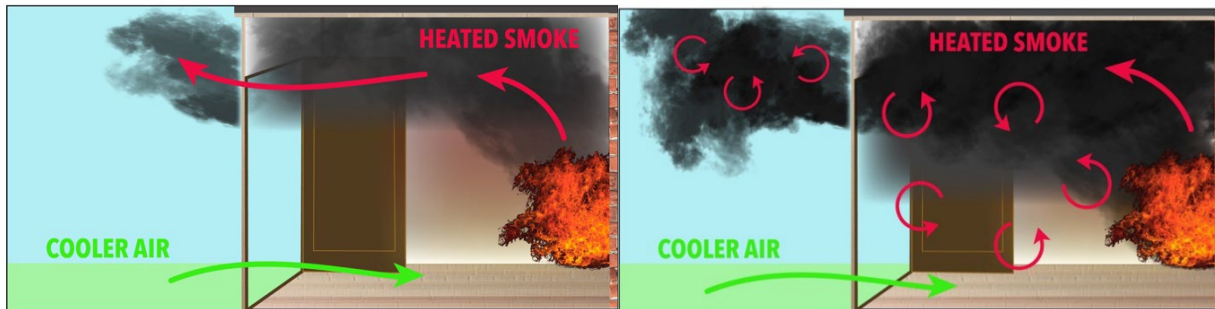

LAMINAR SMOKE

TURBULENT SMOKE

Smoke Density: The apparent density “thickness” of the smoke can be a good indicator of the efficiency of the combustion process. In the early fuel-limited stages where there is plenty of oxygen, the rate of smoke production is lower than in later stages when the fire is becoming ventilation-limited. A large fire which is severely ventilation limited, will produce large volumes of thick dense smoke.

- A. Dense smoke can indicate the fire is a ventilation-limited fire.

SMOKE COLOR

Black: Dark smoke often indicates fuel-rich conditions, due to restricted air supply (ventilation limited). Where flaming or smoldering combustion occurs, the carbon in the fuel is released as soot in the smoke, resulting in a very dark color. If the air supply is sufficient, more of the carbon will react and will produce a lighter colored smoke and brighter flame. If air supply is restricted, less carbon reacts and becomes suspended in the smoke producing a darker colored smoke.

Thick dark smoke indicates an abundance of fuel that was not burned in the fire and is now suspended in the smoke. Given the right conditions, this suspended fuel can ignite.

Brown: Brown smoke can indicate the early stages of the pyrolysis of timber products. The brown color is caused by the process of wood breaking down. In a wood framed building, the presence of brown smoke may indicate that the structure is involved.

Grey: Grey smoke indicates that at least some flaming combustion or smoldering combustion is present. Dark smoke that has travelled some distance can cool and large carbon particles suspended in the smoke can adhere to surfaces. The further the smoke travels, the more carbon

it can lose, resulting in a grey smoke. In a building issuing dark smoke from some areas and grey smoke from other areas, usually the areas with grey smoke are remote from the fire.

White: Application of water to a large fire will generate large amounts of steam which can mix with smoke and create condensation that gives the appearance of white smoke. In this situation, the white color can indicate water is on the fire. The more white condensation that is visible, combined with a reduction in the volume and velocity of dark smoke, indicates progress is being made in extinguishment.

White smoke (not steam) is produced when certain fuels are heated to their pyrolysis temperature and volatile components are released. If the heat continues to increase and there is insufficient oxygen even for smoldering combustion, then the production of white smoke will continue. White smoke can have a very high fuel content (white ghost), represents a significant danger, and should never be treated lightly. When white smoke mixes with oxygen and finds an ignition source, there is potential for a very sudden and powerful ignition.

Smoke Stratification:

- A. Smoke usually stratifies in layers sometimes corresponding with the upper and lower layer. As a fire develops within an enclosure, the thermal interface will lower. The interface height can usually be observed by observing the smoke stratification or using the thermal imaging camera.
- B. The location of the interface (its height in the room) and the neutral plane is important when assessing the potential for rapid fire development.
 1. A high interface could indicate the fire is in early stages of development or that you are remote from the fire area.
 2. A sudden rise in the interface could indicate that ventilation has occurred.
 3. Gradual lowering of the interface often indicates a buildup of hot fire gases, a situation that could progress to rollover and flashover if left uncontrolled.
 4. A sudden lowering of the interface could indicate a rapid intensification of the fire.
 5. A neutral plane that is at or near floor level may indicate that the fire is on a floor below.

FLOW PATH & FIRE TRAVEL

The flow path of a fire describes the route that smoke and flame move away from the seat of the fire toward any outlet(s), as well as the corresponding flow of air into the fire from any inlet(s). Normal Air inside a compartment is made up of gases (such as oxygen and nitrogen). When this air is heated, the gases expand, and the expansion of gases create pressure.

Flow Path: The area(s) within a structure fire where fire, heat, smoke and air flows from an area of higher pressure to an area of lower pressure.

Flow Path Management: It is possible to reduce the rate of fire growth if the inlet(s) and/or outlet(s) can be closed or restricted. In addition, the purposeful management of the flow path can increase firefighter safety during operations.

There may be several flow paths within a structure depending upon the building design and the available ventilation openings (i.e. doors, windows, shafts). The flow within the flow path may be characterized as being unidirectional, bidirectional or dynamic. The shape and position of the smoke/air track at a vent opening can be an important indicator of the intensity of the fire.

Velocity and Direction: When an opening is created in a fire area, the heated gases will flow out of the top of the opening, and cool air will flow in through the bottom of the opening. A sudden inward movement of the air track could indicate the potential for rapid fire development. In these cases, the sudden inward rush of air will cause the fire to intensify and be followed by an outward rush of smoke and/or flame.

Smoke or flame being discharged from the entire ventilation opening (no neutral plane visible) usually indicates that it is an outlet and that there is at least one inlet located somewhere else in the structure.

An opening that is both a ventilation inlet and outlet will show signs of laminar (smooth) or turbulent flow at the neutral plane depending on the stage and intensity of the fire.

A. Unidirectional Flow

A unidirectional flow is a flow of smoke, flame or air moving in a single direction across the full area of the opening. A unidirectional flow path can exist as either an exhaust or an inlet.

B. Bidirectional Flow

Bidirectional flow describes a smoke/air flow moving in opposing directions within the same openings.

C. Dynamic Flow

A unidirectional or bidirectional flow of smoke/air that presents irregular stratification and shape, or alternates in direction (pulsates) is identified as dynamic flow.

Under normal fire conditions, there should be a clearly identified unidirectional flow or clearly delineated bidirectional flow of smoke/flame from a vent opening.

Under normal wind conditions, a room with only one opening will display a bidirectional smoke/air track with a visible neutral plane. In a wind-impacted scenario, the opening can aggressively alternate from a total inlet to a total exhaust outlet with a range of unique vent profiles. This would be an example of Dynamic Flow.

[UL-FSRI: Fire Flows from High Pressure to Low Pressure](#)

DANGEROUS FIRE EVENTS

Generally speaking, in a developing compartment fire, rollover occurs before flashover. Understanding and being able to recognize rollover and flashover conditions and being able to identify a ventilation-induced flashover environment and other dangerous fire events are key factors in Fire Dynamics Size-Up. The



following section will describe dangerous fire events such as rollover, flashover, ventilation-induced flashover, backdraft, black fire, smoke explosion, flash fire, BLEVE and Boilover.

Rollover

As the fire develops and the thermal layer has been formed, pockets of flame may begin to form in the upper layer as the first indication that unburned fuel in the hot smoke may be coming close to its auto-ignition temperature. If it does ignite, a rollover occurs.

Rollover: A condition where the unburned fire gases that have accumulated at the top of a compartment ignite and flames travel through the hot gas layer across the ceiling.

Rollover is when the heated gasses rising from the fire accumulate at the ceiling level. These heated gasses are pushed, under pressure, and spread horizontally across the ceiling. While these gasses are banking down, they are forming the upper layer and are mixing with oxygen. The upper layer becomes a flammable mixture of heated gases. When their flammable range is reached, they ignite and a fire develops, with fire expanding very rapidly and rolling over the ceiling away from the main body of fire. Rollover occurs during the growth stage.

Rollover is different from flashover because in rollover primarily the gasses are burning *not* the entire contents of the room. However, during a rollover event, such a significant amount of radiant heat (energy) is added to the room, that usually within seconds, flashover will occur. For this reason, the presence of rollover indicates that flashover is imminent.

FLASHOVER

Flashover is a transition phase in the development of a compartment fire in which surfaces exposed to thermal radiation reach ignition temperatures and ignite more or less simultaneously.

Flashover: The simultaneous ignition of all of the combustible materials in a compartment and all of the gases built up in the compartment produced by pyrolysis.

During flashover, the environment of the room is changing from a two-layer condition (Upper Layer and Lower Layer/ hot on top, cooler on the bottom) to a single well mixed, untenable hot gas condition from floor to ceiling. The temperature in the compartment typically exceeds 1100' F. In order for flashover to occur, there must be an enclosed space such as a single room. Virtually all combustible surfaces in the enclosed space become ignited during flashover.

The transition period between pre-flashover fire conditions to post-flashover can occur rapidly. During flashover, the volume of fire will increase to fill the entire volume of space in the room; with fire and burning gases likely extending out of any openings in the room (windows, doors, etc.) with substantial velocity.

Flashover occurs during the growth stage. Once flashover has occurred, the fire within the compartment is said to be in the Fully Developed Stage.

Note: The Geometry (the size, shape and volume) of a room affects the formation of the upper layer and thus the heat transfer within a given fire compartment. A flashover may take longer to occur in compartments that have *peaked ceilings* or cathedral ceilings since these features make it difficult for the upper layer to form. Lack of upper layer formation limits the amount of radiant heat produced and radiated back towards the fire and other fuels in the compartment.



Ventilation-Induced Flashover:

When a fire enters the decay stage before flashover occurs due to a reduction in oxygen, but then redevelops and flashover occurs when oxygen is admitted to the fire, is called a ventilation-induced flashover.

Ventilation-Induced Flashover: A flashover initiated by the introduction of oxygen into a pre-heated, fuel rich (smoke filled) oxygen deficient area.

Ventilation-Induced Flashover has become prevalent with modern content fires. Modern content fires rapidly consume more of the available oxygen within the fire compartment creating conditions favorable for a ventilation-induced flashover to occur.

Ventilation-Induced Flashover occurs when oxygen is introduced to a fire which has entered an early decay stage. Once ventilation-induced flashover occurs, the fire within the compartment is said to be in the Fully Developed Stage.

Ventilation-Induced Flashover is similar to a backdraft except a backdraft involves significantly more pressure, causing an explosion.

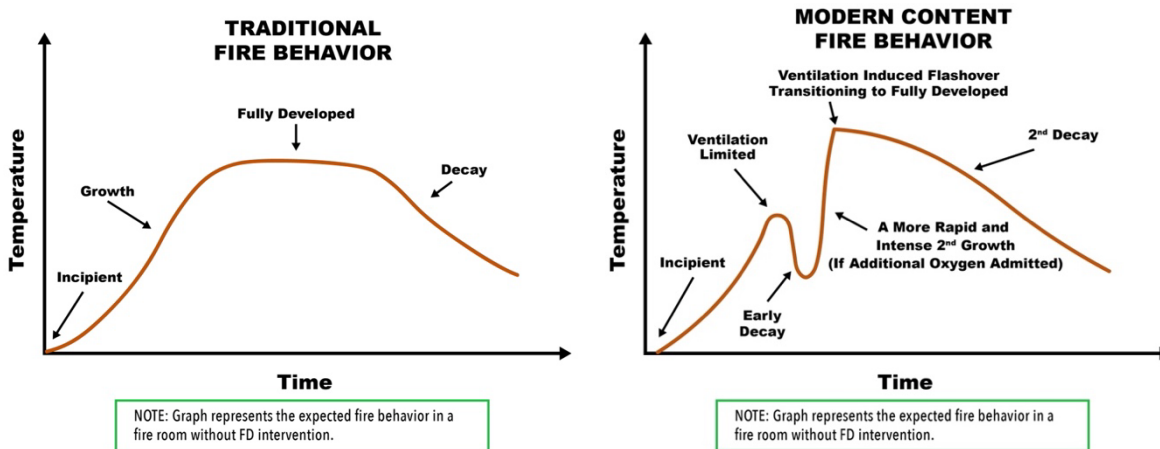

Ventilation will *initially* relieve built up heat and smoke even when conducted ahead of hoseline operations. While all ventilation openings may have an impact on the fire, a member taking a window of a fire room in the oxygen deficient early decay stage will have more immediate effect on fire regrowth than opening the fire apartment door down the hall. If water is not applied to the seat of the fire soon after ventilation occurs, this **temporary improvement period** may be followed by a rapid deterioration of conditions, potentially leading to flashover.

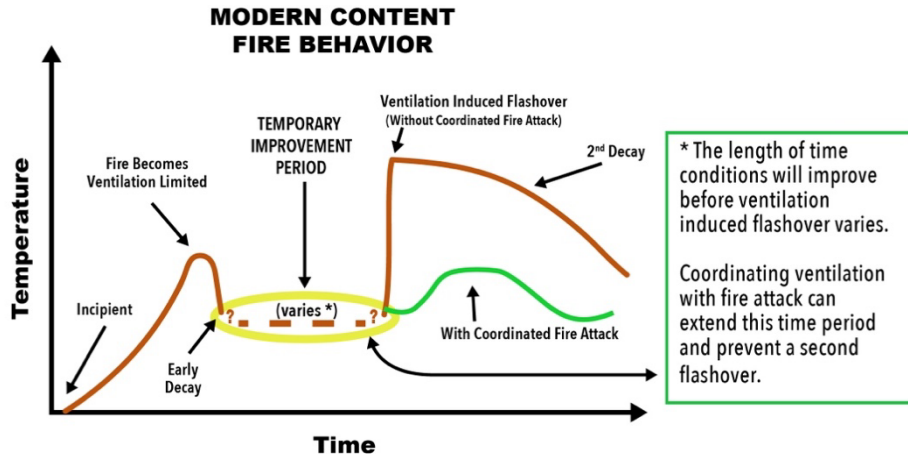

In oxygen depleted environments, this **temporary improvement period** can last for an unspecified amount of time; it can be seconds or several minutes. It is important to note that there is no way to accurately determine how long this temporary improvement period will last. Factors impacting fire rapid re-growth include size and location of the fire, size and location of the ventilation opening, building dynamics and flow paths established between the fire and ventilation opening(s). Firefighters can extend the temporary improvement period by coordinating ventilation with fire attack.

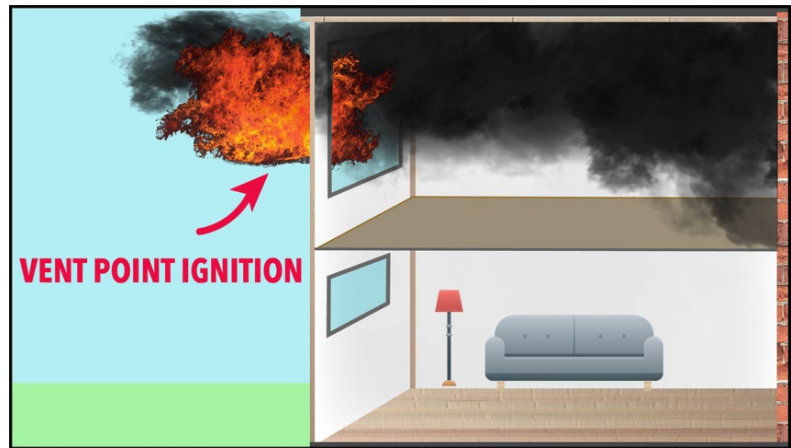

Black Fire: The occurrence of Black Fire is a condition when thick, turbulent superheated fuel rich black smoke has been heated well beyond its ignition point but is so rich with gasses it is beyond its flammable range and is too rich to burn. Black Fire occurs in areas of the fire building which are said to be in the Growth Stage. This can and often does include areas **above** or **adjacent** to rooms of fire that are fully involved and in the fully developed stage.

It is called Black Fire because at the area affected there will be no visible flames, just dark black superheated turbulent smoke. The smoke will be so hot that it will act as if it were fire. This means that the heat from Black Fire will be searing and destructive and it will pyrolyze and consume materials in its path. It can severely burn firefighters.

When Black Fire conditions are present, there is usually an area ahead of the Black Fire area where the main body of fire is free burning and heavily involved in flames. In the Black Fire Area

itself, the smoke will be too rich to burn and there will be no visible flames. Behind the Black Fire area, as the smoke travels remote from the fire area and mixes with more air, there may be an area where the smoke ignites. This ignition can occur in a room behind firefighters who are operating in the black fire area causing them to become trapped. Ignition can also occur on the exterior of the building when the smoke ignites as it is released from a window or door and mixes with air in the atmosphere. This is known as **vent point ignition**.

Black Fire is an extremely dangerous condition to be operating in. Upon recognition of Black Fire Conditions, treat the Black Fire smoke as if it were flames. Immediately flow water into the smoke layer with a hoseline to aggressively cool the area. If you are unable to immediately cool the area, isolate our forces from the fire area by closing a door or some other means if possible, or retreat to an area of safety.

SMOKE EXPLOSION

A smoke explosion can occur either inside or outside the fire compartment when an accumulation of fuel-rich smoke mixes with additional air and falls within its flammable/explosive range. A smoke explosion can occur without warning and occurs *without* a sudden change in ventilation.

Smoke Explosion: A rapid fire development that occurs when a smoke-air mixture falls within its flammable range, either internal or external to the fire compartment, and is ignited in a manner resulting in a significant pressure front. A smoke explosion occurs without an immediate ventilation triggering event.

One common example occurs when smoke migrates and accumulates in hidden areas such as rooms remote from the fire area or void spaces (including cocklofts, attics, or voids within walls). This smoke then mixes with air to fall within its flammable range and encounters an ignition source (or is at a temperature above its auto-ignition temperature), resulting in a flame front propagating through the mixture.

If ignition occurs in a relatively confined space (cockloft, small room, etc.), or if obstacles promote turbulence, the flame front may accelerate, leading to an over pressure situation that may result in structural damage and/or injury or death of nearby firefighters.

BACKDRAFT

Backdrafts are caused when there is an introduction of oxygen to a compartment that has been pressurized by the smoke and fire gases of an oxygen-deficient fire in the Decay Stage. Similar to smoke explosions, backdrafts are accompanied by a significant over-pressure.

Backdraft: A deflagration resulting from the sudden introduction of air into a confined space containing oxygen-deficient products of incomplete combustion.

During a backdraft, the ignition pushes unburned fuel-rich gases ahead of the burning smoke-air mixture as it expands. A large fire ball results as the burning flammable and smoke-air mixture is forced, under pressure, from the compartment. The over-pressurization and dramatic fireballs produced during backdraft can result in damage to the structure and extension of the fire beyond the compartment, and pose several risks to firefighters who are in its path.

A backdraft may lead to a heavy fire condition or may expel all of the fire gases, leaving only localized combustion in its path.

Backdraft Indicators

No visible/active flaming within the compartment and extremely limited or no ventilation of the fire compartment

Sometimes but not always in conjunction with the following:

Pulsating smoke, usually pulsating in an in-and-out movement, giving the impression the "compartment is breathing." Grey-Yellow smoke seeping out from around closed and intact doors and windows. Doors and windows usually very hot and window glass discolored and/or cracked from the heat.

Note: It is important to note that while some or all of these indicators may be present to indicate the possibility of a backdraft, it is possible for a backdraft to occur without indications that the fire is in the decay stage being visible from the exterior of the compartment.

Note: Distinguishing between Smoke Ignitions

- A. Backdrafts and Smoke Explosions will be considered the same; except that Backdrafts will occur immediately following ventilation of the affected compartment.
- B. An event will be considered a Smoke Explosion if it occurred without immediate and direct ventilation of the affected area.

FLASH FIRE (PROPAGATING FLAME FRONTS)

Flash fires involve a flame moving through a flammable mixture with considerable speed, without developing a significant over-pressure.

Flash Fire: A fire that spreads by means of a flame front rapidly through a diffuse fuel, such as dust, gas or the vapors of an ignitable liquid, without the production of damaging pressure.

Flash fires can happen within a fire compartment (such as during overhaul) when embers or sparks can act as an ignition source or external to the compartment in any remote location

where a flammable mixture has collected. Flash fires usually self-extinguish, although sometimes may ignite secondary fires.

Examples of Flash Fires include ignition of dust in a wood shop, vapors from a roach bomb or vapors from a newly stained wood floor.

Note: Flash fires which occur in a confined space can cause an over pressure condition and result in an explosion. This condition would be referred to as an explosion. (e.g., dust explosion).

BOILING LIQUID EXPANDING VAPOR EXPLOSION (BLEVE)

A BLEVE is an explosion caused by the rupture of a vessel containing a pressurized liquid that has reached temperatures above its boiling point.

Characteristics of the stored liquid, as well as the storage container, are important in determining whether there is potential for a BLEVE to occur. When a liquid is heated above its boiling temperature, it will vaporize, causing an increase in pressure in the container. If the boiling liquid is in a sealed, rigid container, the pressure in the container will increase as more liquid boils. If the container is vented, the extra pressure will be released to equalize the pressure inside the container with that outside the container (atmosphere). If the container is not vented, or if the relief vent cannot release the building pressure fast enough, the pressure inside the storage container will increase.

A BLEVE occurs when (1) the liquid in a pressurized vessel is at or heated to a temperature that exceeds its boiling point and (2) the container ruptures, either due to excessive build-up in pressure, or due to tank failure caused by mechanical or thermal damage.

When the rupture is catastrophic, the contents of the vessel will boil almost immediately on release, causing a rapidly expanding vapor cloud. Depending on the temperature, pressure and type of liquid involved, this expansion may be so rapid that it is classified as an explosion and can cause significant damage to its surroundings. If the liquid involved is flammable, the expanding vapor cloud may also be flammable and ignite creating a fire.

BOILOVER

An event in the burning of certain combustible liquids in an open-top tank when, after a long period of quiescent burning, there is a sudden increase in fire intensity associated with the expulsion of burning oil from the tank (NFPA).

When water is added to the fuel, it sinks to the bottom of the container and has little effect on extinguishing the flames which are on the surface of the fuel. Under certain conditions, the water vaporizes into steam causing it to expand more than 1700 times in volume. The rapidly

expanding steam expels the fuel upward and out of the container, which ignites and results in a large plume of burning liquid outside of the container.

Boilover commonly occurs in residential kitchen fires when water is added to a grease/oil fire in an attempt to extinguish the fire. Boilover can be more catastrophic when occurring in a larger flammable liquid fire such as a transformer fire or tanker truck fire. In most cases, water (without a suppression additive) has little extinguishing effect on flaming liquid fires.

STACK EFFECT

“Stack Effect” is a term used to describe the movement of air throughout a building that occurs when the temperature of the interior of a building is different than the temperature of the external environment. Stack Effect occurs in buildings of all sizes including private dwellings; although in hi-rise buildings it is significantly more prominent.

Stack Effect encompasses two distinct dynamics; it affects internal vertical air movement inside the building (up and down the shafts), as well as horizontal air movement (into or out of a floor within the building). Horizontal air movement occurs as air is exchanged between the building’s interior and the external environment (in and out windows) or is exchanged within the building from a given floor into or out of a vertical shaft.

Impact of the Stack Effect

The Stack Effect impacts air movement in a building in two distinct ways:

- A. It impacts the vertical direction and magnitude of air movement inside the building itself. Air inside the building can either move up or down the vertical shafts. This movement will affect the movement of smoke throughout the building.
- B. It impacts the horizontal direction and magnitude of air being exchanged between (1) the interior of the building and the external environment and (2) the horizontal air movement on each individual floor to and from the vertical shafts. Air can either be pulled into the building through available openings (windows, doors), or it can be pushed out of the building. Likewise, air can be pulled into a particular floor from a vertical shaft or pushed out of a particular floor into the shaft. This horizontal movement can affect fire and/or smoke conditions depending on the direction of air movement.

Stack Effect Neutral Pressure Zone

Near the center of the building there will exist an area that experiences no horizontal air exchange at all (air will not be pulled into or pushed out of an opening or pulled into or pushed out of a floor due to stack effect). This area is called the “**Stack Effect Neutral Pressure Zone**”.

The magnitude of horizontal air movement at other parts of the building depends on the distance from this central point; the further the opening is from the middle floor of the building,

the stronger the Stack Effect will be. This means that lateral air movement will be strongest at openings (windows) or locations on the uppermost and bottommost floors.

This condition can cause smoke and fire gasses to bypass several floors near the center of the building (near the stack effect neutral pressure zone), only to be pulled into floors somewhere above or below the center of the building depending on the direction of the stack effect.

Magnitude of the Stack Effect

The magnitude of the Stack Effect will be dictated by the size of the temperature differential between the interior of the building and the exterior environment and the height of the building.

- A. Stack Effect will be more prominent in extreme weather, when air conditioning or heating systems make the temperature inside the building remarkably different from the outside temperature.
- B. Taller buildings will experience a more powerful Stack Effect because more air will be moving over a longer distance inside the building. Also, the presence of large vertical shafts (stairways, elevators, compactors, etc.) will contribute to the strength of the Stack Effect.

Direction of the Stack Effect

The direction of the Stack effect will be dictated by whether the interior of the building is warmer or cooler than the external environment. There is a critical difference, as the air will move in opposite directions depending on this factor and will have the opposite impact on smoke movement and fire conditions in different parts of the building.

- A. **Positive Stack Effect (Winter)** is when the interior of a building is warmer than the external environment.
- B. **Negative Stack Effect (Summer)** is when the interior of a building is cooler than the external environment.

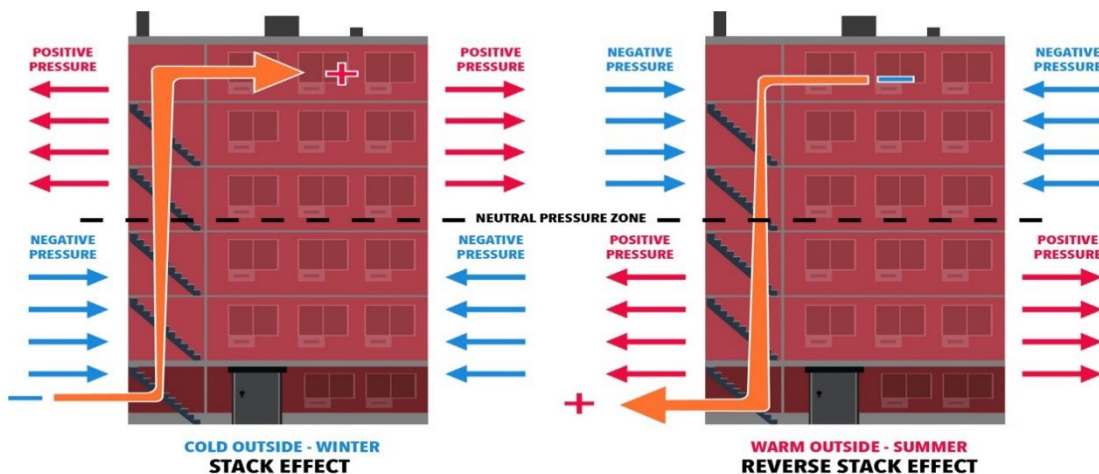

Two Different Situations:

Positive Stack Effect (Winter) vs. Negative Stack Effect (Summer)

Positive Stack Effect (Winter)

- A. In cold weather, air inside occupied buildings is warmer than the air outside the building due to internal heating systems.
- B. As a result, air and smoke movement inside the building will travel upwards via vertical shafts and attempt to exit the building via available openings near the top of the building. At the bottom of the shaft, a negative pressure will be generated, which will have the effect of pulling air into the shaft via available openings near the bottom of the building.
- C. A fire on an upper floor will tend to want to vent out of the windows.
- D. A fire on a lower floor will tend to draw air into the windows creating conditions similar to a wind impacted fire.
- E. Smoke from a lower floor fire will be drawn up vertical shafts within the building and pulled back into floors with greater force as you go higher in the building and further away from the stack effect neutral pressure zone.

Negative Stack Effect (Summer)

- A. In hot weather, air inside occupied buildings is cooler than the air outside the building due to internal air conditioning systems.
- B. As a result, air inside the building will travel downwards via vertical shafts and attempt to exit the building via available openings near the bottom of the building. At the top of the shaft, a negative pressure will be generated, which will have the effect of pulling air into the shaft via available openings near the top of the building.
- C. This is also known as "Reverse Stack Effect."
- D. A fire on an upper floor will tend to draw air into the windows creating conditions similar to a wind impacted fire.
- E. A fire on a lower floor will tend to want to vent out of the windows
- F. Smoke from an upper floor fire will be drawn toward the vertical shafts within the building and will typically travel downward. It can be pulled back into floors with greater force as you go lower in the building and further below the stack effect neutral pressure zone.

**PHOENIX REGIONAL
STANDARD OPERATING PROCEDURES**

EMERGENCY OPERATIONS PLAN

M.P. 201.02

03/2021-R

Page 1 of 3

PURPOSE

The objective of the Emergency Operations Plan is to mobilize the resources of the entire Phoenix Fire Department to an elevated level when circumstances require a commitment beyond normal capabilities. The activation of this plan will cause the Fire Department Tactical Operations Center (TOC) to go into operation. Identified Command Officers will respond to that location. The general categories of situations that would cause the activation of the TOC:

- One major incident affecting a localized or widespread area.
- Two or more working incidents causing a high demand for resources at different locations.
- Numerous simultaneous incidents causing a peak demand on the entire system.
- When determined necessary by the Fire Chief or Executive Staff.

The purpose of the TOC will be to bring appropriate Command Officers and other staff together at a central location and to:

- Analyze the emergency situation.
- Determine what Fire Department and other City resources are needed for the emergency.
- Place additional apparatus in service as deemed necessary.
- Recall appropriate personnel resources as necessary.
- Make Fire Department policy regarding the department's response and management of the emergency.
- Prioritize response and resources as necessary (see Emergency Deployment, M.P. 201.02A)
- Select and provide personnel to staff the City's Emergency Operations Center if opened.

Each Division of the Fire Department is assigned specific roles and responsibilities in order to support emergency operations. It is the responsibility of each Division and Section to be prepared to function according to these guidelines whenever the need is identified.

TOC IMMEDIATE TASKS AND DECISIONS

Command Staff reporting to the TOC will be responsible for the following decisions and tasks:

- Confirm that Emergency Response Staffing Office (ERSO) is manned and prepared to initiate recall, if needed.
- Determine the need for and initiate additional staffing of the Alarm Room.
- Confirm an TOC liaison is established and functioning at the Incident Command Post(s).
- Determine the need for a TOC Liaison at the Alarm Room (preferably the Alarm Room Chief).
- Confirm that resource management has been opened to address any identified logistical needs. This may include preparation of reserve apparatus and deployment of specialized equipment.

**PHOENIX REGIONAL
STANDARD OPERATING PROCEDURES**

EMERGENCY OPERATIONS PLAN

M.P. 201.02

03/2021-R

Page 2 of 3

- Determine what fire companies need to be placed in service and activate apparatus as deemed necessary.
- Determine what personnel resources need to be recalled and initiate recall as deemed necessary.
- Determine and select reporting stations and/or locations for recalled personnel.
- Make personnel assignments as necessary.

RECALL OF OFF-DUTY PERSONNEL

Command Staff at the TOC are responsible for making the decision to initiate recall of off-duty personnel. Personnel may be recalled to stand up additional fire companies. These fire companies may be directed to respond to an incident or provide coverage for a depleted area(s). The ERSO will contact recalled personnel and advise them where to report.

The recalling of off-duty firefighting personnel will be accomplished by NXT system and/or telephone contact with the employee. A list of employees by rank and shift shall be maintained by the ERSO.

STRATEGIC PLANNING (Executive Assistant Fire Chief)

Strategic planning functions under this plan are the responsibility of the Executive Assistant Fire Chief and include the following:

- As directed by the Fire Chief, establish and maintain communications with Mayor, Council, and City Management.
- Activate personnel assigned to the Safety Unit to assist in the TOC or the incident(s).
- Assist the Fire Chief with situation analysis, policy making, and other activities.
- Coordinate the activities of the Fire Prevention Section and provide technical assistance and expertise. Maintain the capability to recall Fire Prevention personnel when needed afterhours.

MEDICAL/SUPPORT SERVICES DIVISION

The Medical/Support Services Division's responsibilities under this plan include the following:

- Initiate the Logistics Staffing Plan in preparation of additional support.
- Liaison with healthcare and hospital stakeholder partners (as needed).
- Prepare reserve apparatus. Efforts to prepare three engines, three rescues, and one ladder company should start upon activation of this plan unless otherwise directed by Command Staff in the TOC.
- Staff warehouse and provide for the delivery of needed supplies and equipment.
- Provide personnel to assist with Rehab and Mass Care functions at major incidents.
- Provide SCBA technicians to perform repairs.
- Contact Public Works to activate additional maintenance and repair personnel as needed.
- Prepare additional command vehicles as needed.

**PHOENIX REGIONAL
STANDARD OPERATING PROCEDURES**

EMERGENCY OPERATIONS PLAN

M.P. 201.02

03/2021-R

Page 3 of 3

URBAN SERVICES/TRAINING DIVISION

The Urban Services/Training Division's responsibilities under this plan include the following:

- Fire Investigations personnel will be used in the investigation of major incidents.
- Maintain a system to call back recruit firefighters and cadets to provide support for major incidents or activities.
- Coordinate with Logistics/Fleet Section on the use of recruit training fire apparatus to facilitate supplemental fire companies.
- Deploy Health Center personnel to assist at incidents or TOC with maintaining the status of injured firefighters.

HOMELAND/HR DIVISION

The Homeland/HR Division's responsibilities under this plan include the following:

- Communicate with Command and other staff to determine location, prepare and activate the TOC.
- Coordinate with other City Departments, County, State, and Federal partners.
- Coordinate any personnel actions that may be required.
- Provide staff to assist ERSO with the recall of personnel as needed.
- Initiate the Incident Management Team structure of planners, liaisons, and other staff as necessary.

TECHNOLOGY DIVISION

The Technology Division's responsibilities under this plan include the following:

- Oversee and administer regional 911 and CAD systems.
- Provide supplemental radios and other communication technical equipment.
- Establish and maintain communication link with the news media.
- Provide internal communication to Fire Department personnel as needed.
- Recall Public Affairs/Community Involvement staff to assist as necessary.
- Provide appropriate and timely public information.

OPERATIONS DIVISION

The Operations Division has the direct responsibility for the delivery of all emergency services.

The Operations Division's responsibilities under this plan include:

- Provide and manage emergency services.
- Direct the placement of additional fire companies and rescue companies in service as necessary (peak-time rescue companies first).
- Respond to the emergency scene to analyze the situation and assume a role on the Command Team as necessary.
- District Commanders may respond to the incident(s), go into service to provide supplemental Command Officer coverage, or may respond to the TOC as deemed necessary.

**PHOENIX REGIONAL
STANDARD OPERATING PROCEDURES**

EMERGENCY DEPLOYMENT

M.P. 201.02A

03/2021-R

Page 1 of 3

PURPOSE

The purpose of this procedure is to provide guidelines for the operational response to situations which create peak demand for emergency services within the Automatic Aid System. Emergency Deployment is intended to significantly increase the number of available emergency response resources.

PROCEDURE FOR EMERGENCY DEPLOYMENT ACTIVATION AND DEACTIVATION

1. Emergency Deployment will be activated at the direction of the on-duty Operations Deputy Chief (i.e., Shift Commander, District Commander, etc.) in conjunction with Alarm Room Headquarters (AHQ) when it is evident that deployment activity may exceed system wide available resource guidelines and/or high activity levels warrant.
 - a. Emergency Deployment may be activated for an individual jurisdiction, multiple jurisdictions or system wide within the Automatic Aid System.
2. Emergency Deployment will be de-activated at the direction of the Operations Deputy Chief in conjunction with AHQ. All modified response requirements will return to normal operating guidelines.

There are three (3) types of Emergency Deployment. The Operations Deputy Chief will determine the appropriate type of Emergency Deployment and communicate this to AHQ.

TYPE 1 EMERGENCY DEPLOYMENT

Activation of a Type 1 Emergency Deployment will automatically modify response requirements for all non-EMS incidents through the following deployment directives:

1. All 3-1 response assignments will be modified to 2-1-1 (ENG/LAD/BC) response assignments.
2. All First Alarm response assignments will be modified to 3-1-1 (ENG/LAD/BC) response assignments.
3. All TRT2 response assignments will be modified to TRT1 response assignments.
4. All HAZ2 response assignment will be modified to HAZ1 response assignments.
5. All TRT1 and HAZ1 response assignment will be modified to a new TRT0 and HAZ0 response assignment. These assignments include MPW, closest appropriate Special Operations crew (either TRT or HMT), the applicable Support Truck and either C957N or C957S. If C957N and C957S are unavailable BC2 or other appropriate BC will be suggested.

TYPE 2 EMERGENCY DEPLOYMENT

Activation of a Type 2 Emergency Deployment will require the on-duty Operations Deputy Chief to call off-duty personnel in to staff brush trucks or other adjunct response apparatus. Coordination between the Assistant Chief of Operations, the on-duty Operations Deputy Chief, on-duty AHQ Chief and/or Supervisor and the CAD Administrator/Technical Services Chief will

**PHOENIX REGIONAL
STANDARD OPERATING PROCEDURES**

EMERGENCY DEPLOYMENT

M.P. 201.02A

03/2021-R

Page 2 of 3

be necessary to determine the appropriate staffing levels, response guidelines, equipment needs and applicable CAD programming. A Type 2 Emergency Deployment will be developed on a case by case basis and may be used for but not limited to Fire, EMS and HAZMAT situations.

Type 2 Emergency Deployment can be activated to address any specific operational issue including pandemic response and in instances where a specific call type is back logging the system due to a high volume of calls or inadequate number of response equipment available in the system. In these cases, case specific or lower priority calls may be assigned to these units and dispatched based on their availability.

CAD programming and the immediate updating of response guidelines to AHQ will be required prior to implementing a Type 2 Emergency Deployment. Emergency Deployment will be deactivated at the direction of the Operations Deputy Chief in conjunction with AHQ. Brush truck capabilities will return to normal and will be placed in an UNV status if not assigned to a call. If other adjunct response apparatus is utilized the capabilities will return to normal and will be placed in the appropriate normal operating status.

TYPE 3 EMERGENCY DEPLOYMENT

Activation of a Type 3 Emergency Deployment will require the on-duty Operations Deputy Chief or designee to call off-duty personnel in to staff reserve apparatus. This will be a manual process and require coordination between the on-duty Deputy Chief or designee, Fleet Management and the AHQ as units are made available. Emergency Deployment will be deactivated at the direction of the on-duty Operations Deputy Chief in conjunction with the AHQ. All reserve apparatus will place themselves in an UNV status if not assigned to a call.

SYSTEMWIDE REDUCTION IN WORKFORCE

Automatic Aid System is committed to making system-wide coverage decisions in the best interest of all customers and firefighter safety. The system is obligated to prepare for a potential reduction in available workforce. Reduction in workforce may have a substantial impact causing a staffing failure within the system. To prevent a staffing failure, all partners must have an emergency staffing and/or mandatory overtime policy. If local emergency staffing policies fail, sworn staff shall be redeployed from support functions to keep emergency response resources in service. If the steps above fail to provide necessary staffing, in-service emergency response resources will be redeployed to address immediate coverage gaps. This process will be administered by the Phoenix and Mesa Regional Dispatch Centers using a parallel methodology to a move-up assignment or system-wide emergency redeployment.

Regional Fire Departments may then recall available off-duty personnel to staff system-wide emergency response resources to 100% capacity. To support this, Automatic Aid Partners may utilize the Arizona Mutual Aid Compact for municipal reimbursement.

**PHOENIX REGIONAL
STANDARD OPERATING PROCEDURES**

EMERGENCY DEPLOYMENT

M.P. 201.02A

03/2021-R

Page 3 of 3

OPERATIONAL INFORMATION

System wide available resource guidelines:

1. Any one (1) large scale incident may use sixty percent (60%) of Automatic Aid resources. Forty percent (40%) of Automatic Aid resources must remain in service to handle routine emergency activity within the system.
2. If two (2) large scale incidents are working simultaneously, each incident may use thirty-five percent (35%) of Automatic Aid resources. Thirty percent (30%) of Automatic Aid resources must remain in service to handle routine emergency activity within the system.
3. If three (3) large scale incidents are working simultaneously, each incident may use twenty-five percent (25%) of Automatic Aid resources. Twenty-five percent (25%) of Automatic Aid resources must remain in service to handle routine emergency activity within the system.

It will be the responsibility of AHQ to coordinate the efficient movement of resources.

EMERGENCY DEPLOYMENT PRINCIPLES

1. Emergency Deployment has been automated in CAD and can be initiated as an independent activation type, or as concurrent activation types, as necessary to mitigate the incident or situation.
2. Activation of each Type of Emergency Deployment will activate a system wide Qpage/phone page so that all jurisdictions within the Automatic Aid System are aware of high activity levels and potential impact to individual jurisdictions.
3. Activation of each Type of Emergency Deployment will generate a MCT message so that all jurisdictions within the Automatic Aid System are aware of high activity levels and potential impact to individual jurisdictions.
4. Activation of each Type of Emergency Deployment will prompt AHQ to open all station packages with a voice announcement advising of Emergency Deployment mode so that all jurisdictions within the Automatic Aid System are aware of high activity levels and potential impact to individual jurisdictions.
5. AHQ has the ability to over-ride a modified response at dispatch, if applicable based on information received.
6. Responding units or a unit on-scene has the ability to balance a modified response to a full assignment if necessary.
7. Emergency Deployment can be implemented for a single jurisdiction, multiple jurisdictions or system wide.

**PHOENIX REGIONAL
STANDARD OPERATING PROCEDURES**

Emergency Power Outage Plan

M.P. 201.02B

11/14-R

12/19-SR

The purpose of this plan is to describe Deployment Services and Fire Operations actions that will be followed during extended power outages with extreme (heat or cold) weather conditions. The aim of this plan is to check and secure the welfare of those customers in the outage area that may be at high risk due to age, health/impairments, or immobility's. The well-being of citizens in this group could be compromised or challenged, having to go without electrical service, heating, and cooling for extended periods of time.

In a reported electrical power outage area, a power company "trouble shooter" or repair crew must arrive at the location of the power outage to survey the damage before an estimated time of repair can be made. Once the estimated time of repair is determined, this information is relayed to the power company operation center. The supervisor in each center should be the contact point for Deployment Services. Deployment Services has direct ring-down lines to both APS and SRP operation centers.

PROCEDURE

The Emergency Power Outage Plan can be implemented when the heat stress factor (temperature and humidity) exceeds 105 or extremely cold temperatures below 34 degrees. This activation may be initiated at the discretion of:

1. North Shift Commander or South Shift Commander
2. Deployment Battalion Chief or Deployment Supervisor
3. Any Executive Staff Chief Officer or Command Officer

The objective of the Emergency Power Outage Plan is to provide basic guidelines for operational response to assist citizens during extended power outages. The specific focus of this procedure is to address the immediate and perhaps long-term needs of high-risk groups such as the elderly, shut-in, and/or infirm during extreme weather conditions.

Upon notification of a significant power outage, the Deployment Battalion Chief Officer or Deployment Supervisor will work in conjunction with the North Shift Commander and South Shift Commander to implement the Emergency Power Outage procedure.

The Shift Commanders should notify on-duty Battalion Chiefs of the implementation of the Emergency Power Outage Plan (All-call).

The Battalion Chief of the affected area should be dispatched to meet with the power company "customer service representative" to establish a partnership to determine and coordinate resource and specific need requirements of that area; (i.e., evacuations/location, Red Cross, door-to-door check welfare, neighborhood activation, transportation, hospitals, loss control, ice, heating, rehab, PIO, and Occupant Services and CR vans) if necessary a Command Team may be activated.

**PHOENIX REGIONAL
STANDARD OPERATING PROCEDURES**

Emergency Power Outage Plan

M.P. 201.02B

11/14-R

12/19-SR

The Shift Commanders and Deployment Battalion Chief Officer will assist in coordinating communications between fire, power company operations, and other agencies.

Weather often times is a major factor in power outages, so it is likely that the Emergency Power Outage Plan will have to be implemented in concert with components of the Emergency Operations Plan and procedures for severe storm.

If evacuation is required, the Evacuation Plans M.P. identifies the method and resources required to execute a small to large-scale evacuation.

When a large-scale power outage creates a high demand for fire department resources and services, and those circumstances require a commitment beyond normal capabilities, the Emergency Operations Plan ~~and/or Emergency Neighbor Activation Plan Kit~~ should be considered.

A system-wide outage is not plausible; a large outage would be managed by utilizing Command Procedures.

OPERATIONAL INFORMATION

The power companies generally experience three types of power outages:

LOCAL OUTAGES	Such as wires or poles down, pole fires or transformer problems which usually will affect a local area.
FEEDER OUTAGES	Such as damage or problems at one of their substations or major distribution lines. Feeder outages will normally cause a larger area to be without power.
ROLLING BLACKOUTS	As a last resort power companies will discontinue electricity to circuits to reduce power consumption and allow the company time to reroute power to compensate for the outage. This should only last 20 – 30 minutes.

These terms are relative to the perspective of each power company, for instance, LOCAL—when a transformer goes out in an area served by SRP, it will usually cut service to approximately 10 residences. Whereas an area served by APS, one transformer outage could affect approximately 35 residences or in some locations could affect as many as 800 homes. FEEDER—a major line or circuit outage in a SRP area would cut services to approximately 200 customers (residences/commercial). Whereas the same outage in an APS area could affect 2,000 (two thousand) of their customers. A rolling blackout can occur when demand for electricity exceeds supply and this usually affects a large geographic area. A rolling blackout can be compared to a large thunderstorm moving across the Valley, resulting in power outages behind the front.

**PHOENIX REGIONAL
STANDARD OPERATING PROCEDURES**

Emergency Power Outage Plan

M.P. 201.02B

11/14-R

12/19-SR

Time without power will be a major determining factor in any plans developed or actions taken.

The power company can provide a good description as to the size, type of occupancies, location, and number of customers in the areas without power. Most rolling blackouts will last 20 to 30 minutes and may not require evacuations.

Both power companies will assign "customer service reps" who will respond to the outage areas to assist with questions and in some cases providing hot or cold drinks and ice to the customer.

Consideration should be given to the following:

1. Duration of the outage (greater than three hours consider evacuation, less than three hours shelter in-place)
2. PIO and media notifications
3. Firefighter call back
4. City coverage
5. Shelters
6. Use of City buses
7. Red Cross
8. Liaison(s) (SRP, APS, etc.)
9. Emergency Operations Center
10. City Official Notifications

**PHOENIX REGIONAL
STANDARD OPERATING PROCEDURES**

ACCOUNTABILITY

M.P. 201.03

01/21-R

Page 1 of 6

PURPOSE

This procedure identifies the accountability system. It is the responsibility of all members operating at an emergency incident to actively participate in the accountability system. It is the responsibility of the Incident Commander to maintain an awareness of the location and function of all companies or crews when operating on any emergency incident. Sector Officers and Company Officers assigned the responsibility of a specific function or tactical area will account for those personnel working in their area of responsibility. In addition, this procedure identifies those actions that are specific to accountability on the fireground or other hazardzone operations. Generally speaking, the accountability responsibilities and actions within this procedure apply to any area that requires the use of an SCBA. The accountability system has proven to increase firefighter safety and provide the Incident Command Team, Sector Officer/Division/Group Supervisor, and Company Officers a means to track the location and function of firefighters on the scene.

ACCOUNTABILITY RESPONSIBILITIES

Accountability is a critical element in maintaining the safety of all firefighters working on the fireground. Each person involved in an incident whether at the strategic, tactical, or task level of an incident must make a strong personal commitment to follow all policies and procedures regarding accountability.

Command/Strategic Level:

- Addresses the strategic level of accountability by the tracking of all crews and sectors/divisions/groups by location and function on a tactical worksheet.
- Command must know who is in charge of each sector/division/group, crews assigned to each sector/division/group, where each sector/division/group is located, and what each sector/division/group is assigned to do.
- Command will include accountability as a major element in strategy and attack planning and must consider and react to any barriers to effective accountability.
- Command will consider air supply when making tactical assignments including rotation of crews.
- Command must obtain personal accountability reports (PAR) from Sector Officers/Division/Group Supervisors and crews.

Sector Officer/Division/Group Supervisor/Tactical Level:

- Addresses the tactical level of accountability by tracking of crews assigned to their sector.
- Sector Officers/Division/Group Supervisors must know the location and function of assigned crews.
- Sector Officers/Division/Group Supervisors must be in his/her assigned area to maintain close supervision of assigned crews.
- Sector Officers/Division/Group Supervisors must obtain PARs of all crewmembers of all companies assigned to his/her sector/division/group.

**PHOENIX REGIONAL
STANDARD OPERATING PROCEDURES**

ACCOUNTABILITY

M.P. 201.03

01/21-R

Page 2 of 6

Company Officer/Task Level:

- Address the task level of accountability and must know where each firefighter is located and what each firefighter is doing.
- Company Officers shall maintain a current PASSPORT of personnel responding on the apparatus at all times.
- Company Officers shall maintain a current MCT roster of personnel responding on the apparatus at all times. This includes MCT roster alignment with the members assigned radio.
- Company Officers must ensure that all crewmembers have proper helmet company ID and nametags on helmet.
- Company Officers must obtain PARs for their crews, which is a confirmation that all members assigned to his/her crew are accounted for and have an adequate exit air supply.
- Company Officers must keep crew intact and maintain an awareness of the crews exit air supply.
- Company Officers must ensure that passport is delivered to their accountability location prior to entering the hot zone and retrieved upon exiting the hot zone.

Engineer:

- Accountability officer who tracks crews and crewmembers who take handlines from his/her apparatus.
- Collects passports from crews prior to entering the hot zone
- Places passport/pouch on discharge gate when hoseline is charged. If no passport is available, engineer should note crew id on pump panel with grease pencil at discharge gate.
- Places hoseline ID tags on each hoseline.

Firefighter:

- Must have proper company ID on his/her helmet.
- Ensure that nametag is placed on passport and roster is updated.
- Stay with his/her crew at all times.
- Maintain a constant awareness of his/her exit air supply.

All Members:

- Immediately update the company passport as they arrive for duty.
- Ensure that helmet IDs are accurate.
- Ensure that nametags are on helmet.
- Ensure that SCBA identification markings are in place.
- All crews work within the incident command system, no free lancing.
- Crews arriving on the scene should remain intact. A minimum crew size will be considered two or more members.
- Each member must have a radio.
- All crews entering the hot zone must have a supervisor.
- All crews will go in together, stay together, and come out together.

**PHOENIX REGIONAL
STANDARD OPERATING PROCEDURES**

ACCOUNTABILITY

M.P. 201.03

01/21-R

Page 3 of 6

- Reduced visibility and increased risk will require close supervision by the Company Officer.
- The entire crew will exit if a SCBA, radio, or any equipment that could compromise safety fails while in the hot zone.

ACCOUNTABILITY EQUIPMENT

The passport system will be used to effectively track firefighters in the hot zone. Accountability equipment for each piece of apparatus and shift consists of a passport with a pouch, small company id tag, helmet ID stickers, and hose ID tag. Passports are bright yellow tags, which measure approximately 3 by 4 inches that are marked with company identification and shift. Nametags of crewmembers assigned to each apparatus are affixed to the passport, which is placed in the passport pouch. The small company id tag is kept in a pocket on the back of the passport pouch and is used to replace the passport at the pump panel in the event that accountability is tracked closer to the building by a sector/division/group. The passport, passport pouch, and company hoseline id tag are kept together as a unit on the apparatus dash at the Company Officer position or passenger side. A Velcro strip will allow the passport/pouch to be affixed to the dash and easily removed.

Each firefighter is issued individual nametags. One nametag for each member presently assigned to the company is required to be placed on the passport. Extra individual nametags should be kept on the underside of their helmet.

Firefighter helmets shall always reflect the ID of the company the firefighter is presently assigned. All personnel, including rovers and constant staffers are required to keep their helmet IDs accurate. Extra helmet ID stickers are kept with the passport in the passport pouch. Nametags shall be affixed to firefighter helmets.

ACCOUNTABILITY HARDWARE USE

Each Company Officer will be responsible for ensuring that the passport and MCT roster reflects only the members presently assigned to the company. Passports shall reflect only those crewmembers about to enter the hot zone. When entering the hot zone with a partial crew, such as when an engineer remains at the engine to pump lines, the Company Officer must remove the nametags of those members not entering the hot zone. The nametags of these members may be returned to the member, placed on the Company Officer's helmet Velcro strip or placed in his/her coat pocket.

Implementation of the passport system will occur at any incident that requires the use of an SCBA. The use of the accountability system will commence as the first unit arrives on the scene. The first arriving company will give an on-scene report by radio and assume command. In the follow up report, their accountability unit identification and geographic location, north, south, east, or west will be announced. As staged units are assigned, Command will give assignments, which will include their respective accountability unit identification and geographic location. Each crew will deliver their passport to the engineer of the engine where they deployed a handline.

**PHOENIX REGIONAL
STANDARD OPERATING PROCEDURES**

ACCOUNTABILITY

M.P. 201.03

01/21-R

Page 4 of 6

When the engineer charges the stretched hoseline with water, their unit's passport, passport pouch, and hoseline ID tag are placed on the discharge gate at the pump panel. In the event a passport is not available, the engineer will use a grease pencil or other material to mark the pump panel. The passports on the discharge gates identify crews and crew members on each hoseline, allow engineers to identify hoselines to change pump pressure, and makes the pump panel an accountability station for the engineer to track crews. Hoseline ID tags are removed from the passport at the discharge gate and placed on each respective hoseline by the engineer. These hoseline ID tags provide a means to identify hoselines that crews entered the building on and are a reference point to find lost or trapped firefighters. As additional companies arrive, their passports/pouches are delivered to the engineer of apparatus that the crew took the handline off. The engineer becomes the accountability officer for those crews that took hoselines from his/her apparatus.

Ladder crews will leave their passport on the apparatus dash when going to the roof to perform ventilation. When going to the interior of the structure, each ladder crew will deliver their passport to the engine closest to their point of entry.

Once a passport is delivered to the pump operator, the passport will remain on the designated discharge gate indicating the "point of entry" to the hot zone. Upon exit, the Company Officer must retrieve their passport. Both the Company Officer and accountability officer will be responsible to see the passports are retrieved. Crews exiting at a different location other than the original point of entry must immediately notify their original Sector Officer Division/Group Supervisor and/or Accountability Officer of their changed status. The passport must be retrieved.

BACK UP ACCOUNTABILITY KIT

A backup accountability kit has been issued to each engine to provide a means to maintain accountability in the event that a crew arrives at an accountability location without their accountability equipment. Each back up kit is kept in a blue nylon bag that contains the following equipment:

- Three blank hoseline id tags – to mark company ID with grease pencil
- One passport pouch
- One blank passport – to mark crew member IDs with grease pencil
- One blank passport with Velcro – to attach crew member nametags from underside of helmet
- One grease pencil

Command Officers should carry a backup accountability pack to maintain and track accountability when assigned to a forward position. The backup accountability pack should contain the following equipment:

- Two blank passports with Velcro – to mark with grease pencil
- One wrist mounted accountability board with Velcro
- Three hoseline tags – to mark company ID with grease pencil
- Two grease pencils

**PHOENIX REGIONAL
STANDARD OPERATING PROCEDURES**

ACCOUNTABILITY

M.P. 201.03

01/21-R

Page 5 of 6

ACCOUNTABILITY TRACKED BY SECTORS DIVISIONS/GROUPS

As Battalion Chiefs are assigned to manage sectors/divisions/groups, the FIT will assume safety sector/division/group responsibilities for that sector/division/group, which includes accountability. At these incidents and at incidents involving a lost or trapped firefighter, "May Day" situations, accountability may be managed by a Battalion Chief and FIT in a sector/division/group closer to the building. The Battalion Chief and FIT would collect the passports/pouches from the initial engine accountability locations. The small company ID tag is removed from the back of the passport pouch and replaces the passport/pouch on the discharge gate at the pump panel. Accountability is now established and tracked closer to the building using their accountability pack.

TERMINATING THE PASSPORT SYSTEM

Passport accountability will be maintained throughout the entire incident. Accountability can be terminated following a report of "fire under control," at which time a PAR for all crews must be obtained. Based on a risk management assessment of the scene, Command will determine whether to continue or terminate the use of the passport system. If visibility remains impaired or if a significant hazard exists, Command may choose to extend the use of the passport system further. Upon termination and release from the incident, Company Officers and crewmembers will ensure that the passport/pouch is accurate and returned to the dash of their apparatus.

PASSPORT RULES

- Passports will reflect only those personnel presently in the hot zone.
- Passports will be delivered to the assigned accountability location prior to entering the hot zone.
- Passports will be maintained at the point of entry to the hot zone.
- Passports never enter the hot zone.
- Passports will be retrieved upon exiting the hot zone.
- Passport accountability location is the engine where the crew deployed hoseline.

PERSONNEL ACCOUNTABILITY REPORT (PAR)

The Personnel Accountability Report (PAR) involves a roll call of all personnel assigned to crews and sectors/divisions/groups that are working in the hot zone. The PAR is a confirmation that all members are accounted for and have an adequate exit air supply. For the Sector Officer/Division/Group Supervisor, a "PAR" is an accounting for all crewmembers of all companies assigned to his/her sector/division/group. For the Company Officer, a PAR is an accounting of all crewmembers assigned to his/her company. Reports of PAR's should be conducted face-to-face within the sector/division/group or company whenever possible.

A personnel accountability report will be required for the following situations:

- Any report of a missing or trapped fire fighter
- Any change from offensive to defensive
- Any sudden hazardous event at the incident - flash over, back draft, collapse, May Day, etc.
- As companies report an all clear

**PHOENIX REGIONAL
STANDARD OPERATING PROCEDURES**

ACCOUNTABILITY

M.P. 201.03

01/21-R

Page 6 of 6

- As companies report under control
- At every 30 minutes of elapsed time
- Any time Command feels it is necessary

MULTI-STORY / HIGH-RISE

The use of an accountability system will commence as the first unit arrives on the scene. The unit containing the passport / pouch and hose ID tag will be removed from the apparatus dash. All crews reporting to the building will deliver their passports to the building lobby. The hoseline ID tag will be taken by each crew to mark their hose line in the stairwell at the standpipe. Lobby Sector/Division/Group will utilize the passports to track all crews and crewmembers in the building. Crews will leave their passports with fire personnel in the fire control room with Building Systems if Lobby/Sector Officer/Division/Group has not been established. The lobby sector/division/group will be responsible for collecting the passports of the initial companies as soon as possible once it is established.

**PHOENIX REGIONAL
STANDARD OPERATING PROCEDURES**

M.P. 201.04 2 In / 2 Out Page 1 of 2
01/14-R

Purpose

The purpose of this procedure is to define the considerations for meeting the 2 in / 2 out procedure requirement based on OSHA **29 CFR 1910.134(g)(4)**. This procedure is meant as the standard application for the Phoenix Regional Dispatch System for the OSHA standard to meet all requirements and at the same time provide for all tactical needs in the hazard zone.

Objective

OSHA states that “once fire fighters begin the interior attack on an interior structural fire, the atmosphere is assumed to be IDLH and paragraph **29 CFR 1910.134(g)(4)** [two-in/two-out] applies.”

The objective of 2 in / 2 out is to have fully equipped firefighters in position during the initial fire attack to react in the event of a Mayday situation.

The 2 in / 2 out procedure will be established anytime firefighters are on air inside a structure and no other units have arrived onscene. In the event the initial company arrives onscene of a fire in the incipient stages the 2 in / 2 out procedure is not required. OSHA further defines an incipient stage fire in **29 CFR 1910.155(c)(26)** as a “fire which is in the initial or beginning stage and which can be controlled or extinguished by portable fire extinguishers, Class II standpipe or small hose systems ***without the need for protective clothing or breathing apparatus.***”

Standard Exceptions to the 2 in / 2 out Requirement at Structure Fires

1. When there is a reported or suspected life hazard where ***immediate action could prevent the loss of life.***
2. When the fire is in an incipient stage as defined above.

During the initial deployment of the first in company, the only radio communications with regards to 2 in / 2 out that are necessary is when the 2 in / 2 out standard is **not met**. The only acceptable reasons for not meeting the 2 in / 2 out standard would be as defined above. Also, the 2 in / 2 out standard is met when the second arriving fire company arrives and is positioned onscene or in Level 1 staging.

When the standard is met, it is critical that the accountability for the 2 in / 2 out team members is managed by the Incident Commander whether they are in the fast attack or stationary command mode. It is the requirement that the Incident Commander (initial arriving Company Officer) account for the individual members of the 2 in / 2 out team. It is also the requirement for the individual 2 in / 2 out team members make the Incident Commander aware of their position and function for accountability.

**PHOENIX REGIONAL
STANDARD OPERATING PROCEDURES**

M.P. 201.04 2 In / 2 Out Page 2 of 2
01/14-R

Operational 2 in / 2 out

- Temporary two-person tactical reserve assigned at the outset of an incident to allow teams to enter an IDLH, or potential IDLH atmosphere.

One primary member of the 2 in / 2 out pair must be solely dedicated to tracking interior personnel. Their function is to react in a safe and effective manner based on their capabilities and ability to communicate in the event of a Mayday by firefighters making the initial fire attack. This position requires appropriate PPE, a radio with the appropriate hazard zone capabilities and to work within the incident management system.

The standards state that the second member of the 2 in / 2 out team may be engaged in other activities within the hazard zone including Engineers operating the pumper.

If members of the 2 in / 2 out team are required to assist with a Mayday situation, it is imperative that they communicate their actions with Command or AHQ. 2 in / 2 out members must maintain a level of accountability to Command even when acting in a Mayday situation.

Standard Implementation of 2 in / 2 out for a Four-Person Crew

The 2 in / 2 out procedure should be used when the initial arriving Company Officer is operating in the fast attack mode as the Incident Commander on an interior attack with another crew member. The plug person assumes the primary 2 in / 2 out position and the engineer assumes the secondary 2 in / 2 out position.

It is necessary that any rescue efforts be initiated as a team (2 members) and well communicated prior to action. Mayday response should always be managed with the Risk Management Plan by the incident commander and acted upon based on the capabilities of the 2 in / 2 out team.

**PHOENIX REGIONAL
STANDARD OPERATING PROCEDURES**

INCIDENT SAFETY OFFICER SYSTEM

(formerly Safety Sector/Section)

M.P. 201.05A

5/11-R

Page 1 of 9

PURPOSE

The Phoenix Fire Department (PFD) holds the safety of our members as our highest priority. The purpose of this procedure is to describe the Incident Safety System that assigns the responsibility for firefighter Safety to an individual beginning with the first arriving Company Officer and the process by which this responsibility is transferred, expanded, and continued as the incident grows up to and including termination of Command. Information related to this M.P. may be found in:

- M.P. 201.01 Command Procedures
- M.P. 201.01A On Deck
- M.P. 201.04 IRIC, RIC Rescue Sector/Group
- M.P. 201.04A Rescue – Lost Firefighters - Command Responsibilities when a May-Day occurs.
- M.P. 202.03A May-Day Communications
- M.P. 202.05C Air Management
- M.P. 205.01H Welfare Sector

OVERVIEW

It is the policy of the Phoenix Fire Department that any member witnessing an unsafe act by another member that may result in injury or worse to one of our members has the authority and obligation to intervene and stop the unsafe act. The Incident Safety System is implemented any time the Phoenix Fire Department responds to an incident. This Procedure describes how an Incident Safety Officer (ISO) and/or Assistant Incident Safety Officers (AISO) are integrated into our Incident Management System, automatically, every time we respond to an incident. The language and safety system structure used in this procedure are intended to conform to NFPA standard 1561, the National Incident Management System (NIMS), and to embody the intent of NFPA 1521.

Fire departments in the Phoenix Regional Automatic Aid Consortium (the consortium) manage safety using two different but interoperable systems; the single dedicated Incident Safety Officer (ISO), and the Incident Safety Officer System (ISOS). It is the intent of this procedure to describe both systems, outline roles and responsibilities of key safety positions, and to explain the interoperability of the systems. While these two different systems exist for smaller scale incidents within the region, when incidents escalate to greater alarms and command van operations are initiated there exists only one formalized safety system. This is also described in this procedure.

This procedure in no way diminishes the responsibility of each and every member to safe work behaviors and to operate within standard operating procedures at all times. Company officers carry an additional responsibility of ensuring that all members of their crew are operating in a safe manner. Chief Officers and sector officers must also insure that operations are conducted safely.

DEFINITIONS

This section briefly describes the positions listed below. Further details and duties for positions are included in the body of this procedure.

Incident: An incident is described as “any emergency situation that threatens life, safety, or property”. Timely response and effective management of EMS, rescue, hazardous material release and fire control situations represent the most immediate priorities of the fire department.

**PHOENIX REGIONAL
STANDARD OPERATING PROCEDURES**

INCIDENT SAFETY OFFICER SYSTEM

(formerly Safety Sector/Section)

M.P. 201.05A

5/11-R

Page 2 of 9

Incident Commander (IC): This refers to the position within the Incident Command System (ICS) that is in charge of incident management. The IC has overall responsibility for the safety of responders working at an emergency scene. That responsibility cannot be delegated. The SOFR/ISO assists the IC and acts as the IC's eyes and ears on matters related to safety, and has the authority to manage safety as described further in this procedure.

Support Officer: A position within ICS that supports the IC. This position functions as the Incident Safety Officer in the ISOS until command van operations are commenced and a Safety Officer is assigned.

Sector Officer: This refers to the position within ICS that is assigned to a geographical area or particular function and manages units assigned to these areas during incidents.

Field Incident Technician (FIT): A company officer assigned to work with a command officer. Often this position is assigned the Support Officer/ISO or Assistant Incident Safety Officer (AISO) role during incidents. Some cities in the Automatic Aid Consortium use a Battalion Safety Officer (BSO) to fill this position.

Safety Officer (SOFR)/ Incident Safety Officer (ISO): A member of the Command Staff responsible for monitoring and assessing safety hazards or unsafe situations and for developing measures for ensuring personnel safety.

Assistant Incident Safety Officer (AISO): An individual appointed or assigned at an incident scene by the Incident Commander (IC) to assist the ISO in the performance of ISO functions.

Initial Rapid Intervention Crew (IRIC): Temporary two-person team assigned at the outset of a working fire to allow a two-person team to enter the structure to perform primary search and rescue when information indicates a potential life hazard situation that can be resolved by rapid search and rescue.

Rapid Intervention Crew (RIC): Four-person crew fully equipped on site, in a ready state, to immediately react and respond to rescue firefighters.

Incident Safety Plan: Hazard control strategies developed by the ISO to address the incident action plan and the type of incident encountered.

INCIDENT SAFETY SYSTEM – DEPLOYMENT MODEL

An incident safety system will be implemented every time the Phoenix Fire Department responds to an incident. The incident safety function begins with the first arriving unit, typically the company officer/IC as part of the initial size up and continues until the incident is terminated. Safety is integrated in the strategic decision making process of looking at critical fireground factors present at the incident, and applying the risk management profile to choose an appropriate strategy and develop an Incident Action Plan (IAP). This process begins implementation of the incident safety system, and identifies the initial IC as responsible for the safety function; this IC is the initial IC/ISO. The initial IC/ISO maintains this responsibility until Command is transferred or the incident is terminated.

**PHOENIX REGIONAL
STANDARD OPERATING PROCEDURES**

INCIDENT SAFETY OFFICER SYSTEM

(formerly Safety Sector/Section)

M.P. 201.05A

5/11-R

Page 3 of 9

Role and responsibility of the initial IC/ISO:

- Follow Phoenix Regional Standard Operating Procedures
- Use the Standard Risk Management Plan
- Analyze critical fire ground factors present at the incident
- Determine a strategy (Offensive or Defensive)
- Establish the Personnel Accountability System
- Provide a standard initial radio report that includes an On-Scene Report and Follow-up Report as defined in Command Procedures M.P. 201.01 08/10/R
- Establish Initial Rapid Intervention Crew (IRIC)
- Manage incoming resources until incident command is passed to another arriving company officer or command officer.
- Provide for the ongoing safety of all members involved in the incident

This initial company officer as the IC/ISO provides the beginning of the Incident Safety Officer System (ISOS) and insures that firefighter safety is a priority upon arrival of the first unit and is maintained through standard transfer of Command and ISO responsibilities until the incident is stabilized or Command is terminated.

EMS (one or two units) and Still Assignments

For incidents such as a still assignment or car fire, and one or two company response to an EMS call, the company officer maintains the role of IC and ISO. The company officer's safety responsibilities include:

- Manage task level safety concerns (driving safety, appropriate PPE, equipment use, etc.)
- Size up critical factors and apply the Risk Management Plan at all incidents
- Manage crew accountability through sight, voice, or touch
- Actively monitor air supply of crew
- Monitor crew member fatigue and need to for recycle
- Communication and mitigation of hazards
- Continue monitoring and reevaluating incident hazards and risk /benefit of actions
- Request additional resources and command components as necessary

Those filling the role of IC/ISO must be a capable of filling the role of company officer.

Structure Fire Assignments (3-1's, First Alarms)

Individual jurisdictions may customize the primary and secondary response requirements on a given Nature Code. CAD will automatically dispatch the required units per Nature Code entered for each jurisdiction. The RSPREQ command may be utilized to determine the specific primary and secondary response requirements per Nature Code for an individual jurisdiction:

Format: RSPREQ *Nature Code. Jurisdiction Code* (3 letters)

Example: RSPREQ STR1A, PHX

The first arriving company officer, following standard Command Procedures will assume Command and become IC #1. IC #1's role includes both Command and Incident Safety Officer. When information indicates a potential life hazard situation exists that can be resolved by a rapid search and rescue by the first arriving company (four person crew), the IC may establish an IRIC. A Firefighter and Engineer can fill this role while the IC and the other firefighter conduct a rapid search and rescue. One member of the IRIC must monitor the tactical radio channel and both members must be prepared to assist the interior portion of the crew if needed.

**PHOENIX REGIONAL
STANDARD OPERATING PROCEDURES**

INCIDENT SAFETY OFFICER SYSTEM

(formerly Safety Sector/Section)

M.P. 201.05A

5/11-R

Page 4 of 9

The first arriving response command officer (usually a Battalion Chief), following standard transfer of Command procedures will assume Command and becomes the IC. The FIT assigned to the IC becomes the support officer and assumes the responsibilities of the Incident Safety Officer. Company officers continue to manage the task level safety of their crews.

Note: In some departments within the consortium, responding BC's may not have a FIT. If the first arriving BC does not have a FIT, and assumes Command, he/she assumes both Command and ISO responsibilities until a support officer/ISO is assigned.

It is the Responsibility of the IC to perform the Functions of Command to achieve the Tactical Objectives.

- Assume and announce Command and establish an effective initial command position (Command Post).
- Rapidly evaluate the situation (size up)
- Initiate, maintain, and control effective incident communications.
- Provide and manage a steady, adequate, and timely stream of appropriate resources.
- Identify the incident strategy, develop an Incident Action Plan (IAP), and assign companies and personnel consistent with plans and standard operating procedures.
- Develop an effective incident organization using Sectors/Divisions/Groups to decentralize and delegate geographic and functional responsibility.
- Review, and revise (as needed) the strategy to keep the IAP current.
- Provide for the continuity, transfer, and termination of Command.

Roles and Responsibilities of the Support Officer:

- Define, evaluate, and recommend changes to the incident action plan.
- Provide direction relating to tactical priorities and specific critical fireground factors.
- Become the Incident Safety Officer
- Evaluate the need for additional resources.
- Assign logistics responsibilities.
- Assist with the tactical worksheet for control and accountability.
- Evaluate the fireground organization and span of control.
- Other duties as necessary.

The next arriving BC can be assigned Recon when appropriate or assigned to the most critical Sector/Division or Group. **Note:** Sectors Divisions and Groups are addressed in M.P. 201.01 Command Procedures. For the remainder of this M.P. we will refer to Sectors with the understanding that some departments will substitute divisions and/or groups where appropriate.

Once assigned to a sector, the BC assumes the responsibilities' of a Sector Officer as described in Command procedures. The BC's FIT becomes the Sector Safety Officer and an AISO for the incident.

Role of the FIT as a Sector Safety Officer (AISO) partnered with a BC

- Perform Sector Safety Officer (AISO) function/role
- Assess and address safety concerns within the sector
- Assist the BC with managing the sector (stay together)
- Manage accountability within the sector (hose tags too)
- Provide air management within the sector
- Manage work/rest cycles within the sector
- Manage the sector's On-Deck crews recycle and rehab

**PHOENIX REGIONAL
STANDARD OPERATING PROCEDURES**

INCIDENT SAFETY OFFICER SYSTEM

(formerly Safety Sector/Section)

M.P. 201.05A

5/11-R

Page 5 of 9

- Establish communications with the ISO (you will call them 'Command') once the IC has assigned a Safety Channel
- Coordinate with other Sector Safety Officers (AISOs)

On-Deck Companies

"On Deck" is defined as; a forward staging position located just outside the immediate hazard zone, safely distanced from the entrance of a tactical position/Sector. On Deck crews will be supervised either by the Sector Officer or Company Officer and they will remain On Deck until assigned by the IC or Sector Officer. The most likely assignments for On Deck companies are:

- Reinforce a position within an assigned sector
- Crew relief within an assigned sector
- Any other tactical position assigned by the IC
- Rapid Intervention Crew

On Deck provides the IC with the ability to move companies from Level I or Level II staging to a forward position providing a tactical reserve on the fire ground., On-Deck also allows the IC to maintain a continuous work cycle in a sector and provide a back-up crew with immediate intervention capability in any given sector (RIC).

Examples:

Garden apartment complexes, large commercial assignments and high rise fires are all examples of where 'On-Deck' would be used to provide a tactical reserve and a RIC in forward sectors. House fires are another situation where the use of On-Deck helps the IC function more efficiently. Rather than piling additional companies into a small structure, the IC can place them On-Deck and wait for reports from interior crews as to their manpower and resource needs. This placement also eliminates the need to tie up personnel occupying a RIC (rescue) position.

On-Deck Company Use to Assist with a Rescue

The ability to respond quickly to a May-Day situation is one of the most important reasons to assign companies to On-Deck positions. Assignment to the task of firefighter rescue requires a level-headed, coordinated and quick approach. Companies assigned to On-Deck must prepare themselves to function as rescue crews by performing the following tasks/actions:

- Monitor tactical radio channel;
- Retrieve RIC Bag and confirm contents;
- Confirm TIC is in a ready state;
- Determine which line each interior company is on—(hose tags);
- Coordinate the opening of doors and windows;
- Illuminate entrance/exits;
- Develop and discuss a possible search and rescue plan.

On-Deck Company Actions for Rescue include:

- Confirm May-Day information;
- Determine resource and equipment needs based upon May-Day report;
- Determine last known location of firefighter/crew in trouble;
- Communicate plan with crew;
- Implement Plan;
- Utilize information and technology (radio reports, TIC, flashlights, etc.);
- Monitor air supply;
- Provide C.A.N. report to Command.

**PHOENIX REGIONAL
STANDARD OPERATING PROCEDURES**

INCIDENT SAFETY OFFICER SYSTEM

(formerly Safety Sector/Section)

M.P. 201.05A

5/11-R

Page 6 of 9

C957 North and South

On all first alarm or greater incidents cars 957 north and south or BC152 will be dispatched and will fill the role of a mobile AISO when assigned by the IC to provide an additional layer of safety. If C957 or BC152 feels there is a need to enter the hot zone he/she must team up with the second C957 and communicate with Command to describe conditions, the reason to enter the hot zone, and their plan. The C957/BC152 team will not enter the hot zone until the IC approves their plan.

In addition to being company officers, C957 personnel are cross trained in Hazardous Materials and Technical Rescue. This makes them a valuable resource at all Special Operations calls and may be paired up to perform recon and mobile incident safety for the IC.

In addition to the above duties, C957 may be assigned the following duties:

- Secure Utilities
- Work with the responsible party at commercial or apartment fires
- Isolate known hazards
- Follow up with defined hazards such as lines down etc.
- Work with utility companies

Greater Alarms and Command Van (CV) operations

When transitioning to the CV the IC and support officer/FIT retain their positions as the IC and the Support Officer/ISO. The IC and Support Officer now join the Senior Advisor and the three of them become the Command Team. When an ISO qualified person arrives at the Command Post (CV), the Senior Advisor may assign him/her to the position of ISO. The Support Officer (FIT) can now focus on supporting the IC and the ISO can focus on Incident Safety.

The Incident Safety Officer (ISO) function operating in the Command Van (CV) works under the direction of the Senior Advisor (SA) and provides the incident commander with a second set of eyes and ears for fire ground operations. The presence of an ISO enables Command to set up a tactical safety channel that can communicate location, accountability, resource needs, and sector safety concerns to the command team without using valuable radio time from the tactical channel.

The tactical safety channel also provides for an additional communication tool for sector officers to communicate with the command team in the event of a significant incident situation ("May Day" building collapse, explosion, etc) that dominates radio traffic on the assigned incident channel. The channel should not be used for tactical reports or resource requests unless contact on the tactical channel is unavailable and the report or need is critical in nature.

STRATEGIC INCIDENT SAFETY OFFICER RESPONSIBILITIES

- Identify the Safety Channel assigned by the dispatch center.
- Obtain a briefing from the Command Team that includes the incident action plan (IAP).
 - The ISO monitors the IAP, conditions, activities and operations to determine whether they fall within the criteria as defined in the department's risk management plan. The ISO shall take necessary action, through the IC, if activities do not fall within the risk management plan.
- Using a tactical worksheet, identify the existing organizational structure.
 - This can be accomplished by working with the CV staging officer by using the resource list function of the staging officer's computer.

**PHOENIX REGIONAL
STANDARD OPERATING PROCEDURES**

INCIDENT SAFETY OFFICER SYSTEM

(formerly Safety Sector/Section)

M.P. 201.05A

5/11-R

Page 7 of 9

- Once Command has advised the tactical level (Sector) Safety Officers (AISO's) to go to the Safety Channel, contact each sector safety officer and assure that the department's personnel accountability system is being used and confirm resources assigned.
 - Provide the SA with any differences between the organizational assignments Command has and what is reported by the sector safety officers.
- Provide the SA with any resource requests from sector safety officers.
- Offer judgment to the SA on establishing control zones and no-entry zones and ensures that established zones are communicated to all members present on the scene.
- Ensure that the IC establishes the incident scene rehabilitation tactical level management component during the emergency operation.
 - Critical incident stress interventions should be recognized and the IC should be notified if such circumstances require response.
- The ISO shall communicate to the IC the need for additional safety officers and/or tactical specialists due to the need, size, complexity or duration of the incident.

TACTICAL INCIDENT SAFETY OFFICER RESPONSIBILITIES

- Identify the Safety Channel assigned by Command.
- Size up the sector of responsibility–
 - Monitor the Sector Action Plan, conditions, activities and operations to determine whether they fall within the criteria as defined in the department's risk management plan.
 - Alter, suspend, or terminate activities that are unsafe or involve an imminent hazard.
 - Survey the sector – identify hazards and potential hazards
 - Communicate the building size, layout, construction type,
- Assure that the department's personnel accountability system is being used within the sector and confirm resources assigned.
 - Wear full protective clothing and SCBA and operate just outside the "hot zone"
 - Confirm sector assignments and companies assigned to sector
 - Utilize accountability tools provided at the task level (passports, hose line tags, accountability boards, etc)
 - Develop a rescue plan – revise the plan as conditions change
- Offer judgment to the ISO on establishing control zones and no-entry zones and ensure that established zones are communicated to all members present in the sector.
 - Ensure the safety of crews – make sure the proper equipment is being utilized and that personnel are operating in a safe position
 - Fire line tape (yellow) helps to control bystanders and the scene
 - Hazard tape (white/red) helps to control firefighters
 - No Access tape (red/black) identifies exclusion zones for all personnel
- Communicate the need for additional safety officers and/or tactical specialists in the Sector due to size, complexity or duration of the incident to the ISO.
- Establish RIC team deployments in each hazard zone area.
 - Assure that the RIC Bag (air and tools) have been deployed in the sector
- Advise the IC of hazards, fire extension and collapse potential.
 - Forecast needs
- Evaluate visible smoke (color, volume, density, velocity, location) and fire conditions (location and size) and advise Command on the potential for flashover, back draft, blow up, or other events that could pose a threat to operating crews.

**PHOENIX REGIONAL
STANDARD OPERATING PROCEDURES**

INCIDENT SAFETY OFFICER SYSTEM

(formerly Safety Sector/Section)

M.P. 201.05A

5/11-R

Page 8 of 9

- Monitor the accessibility of entry and egress of structures and its effect on the safety of members conducting interior operations
 - Track personnel accountability closer to building
 - Air management – manage time on air/working time and work/rest cycles
 - Manage on deck crews – share information, including rescue plan
 - Manage the cycling of crews to rehab
 - Progress reports
 - Constantly monitor crews and building conditions
- Develop an overhaul plan for the Sector that falls within the IAP

The additional layers of safety provided at this level of organization are:

- Provides a critical secondary means of communication during a Mayday
- Reconciling accountability (a cross check to make sure people are where command thinks they are)
- Eliciting safety concerns from the Sector Safety Officers
- Completion of safety worksheet to include identification of safety issues and plan to mitigate
- Second means of strategic/tactical/safety communication with the command team

Transition to multi operation period events and a Type I or III Incident Management Team (IMT).

When the authority having jurisdiction (AHJ) has decided that the scale, complexity, and duration of an incident warrant the use of an IMT the ISO will participate with the Command Team in an interagency briefing. The ISO will provide current safety issues during the briefing when appropriate. The IMT Command Staff including the Safety Officer are the recipients of this briefing. Following the formal briefing, the ISO will meet with the IMT Safety Officer and provide the current safety worksheet, and if possible assist in the safety planning process for the upcoming operational period. More about transitioning to an IMT appears in M.P. 201.01 Command Procedures.

SINGLE ISO – DEPLOYMENT MODEL

Departments in the consortium using the single ISO model either dispatch an ISO or assigns the ISO position to a qualified Command or Company Officer during incidents. Command should only assign units qualified and familiar with the ISO. Once the IC assigns an ISO they will be identified as SAFETY on the tactical channel. Single ISO's shall remain out of the hot zone unless they are paired up. Single ISO's should provide the following functions:

- Incident Recon
- Assess the risk/benefit of operations
- Communicate and report safety issues to command
- Intervene as necessary to provide for safety using one of the three methods described below

SAFETY INTERVENTION

Intervention at scene operations involves three approaches. First is for life threatening situations, the second is for non-life threatening situations; the third approach occurs in the on-going incident planning process.

**PHOENIX REGIONAL
STANDARD OPERATING PROCEDURES**

INCIDENT SAFETY OFFICER SYSTEM

(formerly Safety Sector/Section)

M.P. 201.05A

5/11-R

Page 9 of 9

First Approach- life threatening conditions:

Any LIFE THREATENING conditions will be corrected immediately and directly. Where time permits, Command must be notified. Corrective action will be initiated by Command immediately. In obvious life threatening situations that do not allow time for Command's intervention, the Safety Sector/Section shall immediately stop any action, or countermand any order, under these circumstances by DIRECT and IMMEDIATE intervention (i.e., order crews out of a building, countermand an order for crews to go to the roof etc.). Such action may be taken with the understanding that the Safety Sector/group works for Command and is accountable to Command for actions taken. **COMMAND MUST BE IMMEDIATELY ADVISED OF ANY DIRECT INTERVENTION BY THE SAFETY SECTOR/SECTION UNDER THESE CIRCUMSTANCES.**

A change of strategy and/or tactics by Command or Sector officers may be required as a result of the Safety officer's actions. Sector officers must be notified of hazards, required safety corrections, or updated on the strategic plan, tactics, and objectives.

EMERGENCY TRAFFIC SHOULD BE USED FOR ANY CRITICAL EMERGENCY NOTIFICATIONS/ALERTS REQUIRED AT THE INCIDENT SCENE!

Second approach- non life threatening conditions:

The second approach is for non-life threatening situations and involves a more "one on one" correction of safety problems with individual firefighters, company officers, and/or sector officers (i.e. require SCBA, correct ladder position) and often does not affect incident strategy. This approach is the most frequent type of interaction. Where corrective action does not affect Command's strategy; Command may not need to be notified. Corrected items should, however, be noted for discussion at a critique of the incident.

Third approach- on going incident planning:

The third approach occurs in the on-going incident planning process. Upon the implementation of the Safety Sector/Section, Command must provide the Safety Sector/Section an overview of the incident action plan and specific details of the safety plan. The Safety officer, upon his/her arrival, will confirm that a safety plan is in effect, review it, and provide recommendations as needed. In some cases Command may request that the Safety Sector/Section officer develop a proposed safety plan and recommendations for Command.

Command must be kept aware of any adjustments that affect overall site operations, or the strategic plan, via frequent and timely progress reports.

The Safety Sector/group/ AISOs must remain a part of the on-going planning process with Command and/or the Safety Officer.

The officer, assuming Safety Sector/group responsibilities, may utilize any previous Safety Sector Officers to his/her best advantage, coordinating resources and incident assignments as approved by Command.

**PHOENIX REGIONAL
STANDARD OPERATING PROCEDURES**

Support Sector

M.P. 201.05B

04/18

Page 1 of 2

Purpose

This procedure establishes a standard structure and guidelines for the provision of Support Sector at all incidents requiring response from Resource Management, and incidents involving special supply needs.

Procedure

The Resource Sector is a part of our Incident Command System and may be assigned under the Logistics Section Officer. The responsibilities assigned to the Resource Sector will vary to some degree in each situation depending on type, size and complexity of operations. The specific responsibilities will include:

- Assisting the Logistics Section Officer in initial and continuing evaluation of support needs.
- Providing and re-supply of all expendable supplies, such as air, oxygen, medical supplies, foam, Gatorade, food, etc.
- Providing and coordinating field refueling of apparatus.
- Liaison with Equipment Management to provide for the ongoing performance of all Department apparatus.
- Providing and coordinating equipment and manpower for delivery of fire hose and other equipment to the scene and/or back to stations.
- Provide for the delivery to the incident site of specialized and backup equipment, as may be needed.
- Coordinate provision of specialized equipment or services required at the scene from other City departments or outside agencies, and provide liaison as required.
- Coordinate the exchange of portable radios and communications equipment requiring servicing.

It is the responsibility of Command to make an early determination of situations requiring the establishment of the Resource Sector or the Logistics Section, and to assure that the Resource Officer (RM-50) on call has been notified and is responding to the incident. Notification can be made through Deployment. Command may assign an individual or company to establish a Resource Sector prior to the arrival of the Resource Officer.

It is the responsibility of the Resource Management Deputy Chief to provide the designated personnel and response capability to meet the requirements of this procedure. This response capability is available on a 24-hour basis through the on-duty Resource Officer (RM-50).

**PHOENIX REGIONAL
STANDARD OPERATING PROCEDURES**

Support Sector

M.P. 201.05B

04/18

Page 2 of 2

It is the responsibility of RM-50 to respond to all working first alarm incidents or greater, or any other incident where response is requested by Command. RM-50 will report to the Command Post on arrival and verify establishment of the Resource Sector.

RM-50 will check with Command for any particular needs or problems which have been identified. Unless otherwise directed, RM-50 will automatically assess the situation in terms of support requirements. RM-50 will coordinate the response of additional Resource personnel and make assignments to provide for completion of assigned responsibilities.

RM-50 will remain at the Command Post and respond to any particular needs identified by Command or the Logistics Officer. Progress reports will be made to Command or the Logistics Officer as necessary. RM-50 is responsible for determination and notification of personnel at the Resource Management facility, if necessary, to further support Resource Sector needs on the incident. For major incidents, the Resource Management Deputy Chief will respond to the incident to manage Resource Sector. Other Resource Management Division Officers and Section heads may be requested to respond to the scene of all second alarm incidents or greater.

Fleet Management provides 24-hour service to maintain apparatus and equipment and to meet emergency needs of the Department. This service is maintained by three Fire Engineers working a 56-hour week. The on-duty Fire Engineer may be contacted at 261-8744.

**PHOENIX REGIONAL
STANDARD OPERATING PROCEDURES**

Lobby Sector

M.P. 201.05C

11/14-R

12/19-SR

The following outlines the directives for Lobby Sector.

PROCEDURE

Lobby Sector is used to control access to a building or area during fires, hazardous materials incidents, rescue operations or any other situation where it is necessary to control and maintain accountability for the entry and exit of personnel. The Lobby Sector Officer is responsible for the following:

1. Identified all entrance/exit points
2. Control all access points when alternate entrances are present
3. Identify suitable entrance/exit point or location
4. Maintain full accountability
5. Record names, times and assignment of personnel
6. Collect all accountability tags
7. For High-rise buildings, normally Lobby Sector is the ground floor lobby area
8. Special Ops Incident: Define perimeter with HAZARD ZONE tape

*****Limit Entry to authorized personnel with appropriate PPE*****

OPERATIONAL INFORMATION

Lobby Sector is used to control access to a building or area necessary to maintain and control accountability for the entry and exit of personnel. Access control is established at an identified entrance/exit point from the building or area involved. In the case of a high-rise building this is normally the ground floor lobby area. In other cases it may be any suitable entrance/exit point or a location designated to meet the needs of the situation.

In the case of a technical operation, e.g., hazardous materials incident, trench rescue, or confined space, the perimeter shall be defined by HAZARD ZONE tape with an entrance/exit point identified.

The Lobby Sector is the only location where personnel shall enter or exit from the controlled area in order to maintain full accountability. Lobby Sector personnel must control all access points when alternate entrances are available.

Lobby Sector personnel will limit entry into a controlled building or area to those authorized by Command and having the required level of protective clothing and equipment appropriate for the situation.

The Lobby Sector will record the names, times, and assignments of all personnel entering and exiting the controlled area. Accountability tags will be collected from all personnel entering and should be retrieved on departure.

**PHOENIX REGIONAL
STANDARD OPERATING PROCEDURES**

Lobby Sector

M.P. 201.05C

11/14-R

12/19-SR

BUILDING/AREA ACCESS CONTROL

A Lobby Sector should be established by Command at high-rise fires and other situations where control of access is necessary. When beginning operations at these incidents, at least one firefighter from the initial arriving companies should be left to establish a Lobby Sector. A company should be assigned to establish Lobby Sector as quickly as possible and additional resources may be needed in major situations.

When Lobby Sector is established all personnel entering the building or area must report to Lobby Sector before reporting to any other sector or assignment. Company Officers will keep crews intact while awaiting assignment. Civilian personnel entering the building area shall be accompanied by a firefighter with a portable radio.

For primary responsibilities assigned to the Lobby Sector at a High-rise building incident see High-rise Plans procedure.

Other incidents that may require a Lobby Sector shall include hazardous materials, confined space, trench rescue, water rescue, structural collapse, and any other incident where control of access is critical.

**PHOENIX REGIONAL
STANDARD OPERATING PROCEDURES**

Environmental Sector

M.P. 201.05D

11/14-R

12/19-SR

The purpose of this procedure is to establish guidelines for handling large-scale events during and after fire ground mitigation. These incidents could include multiple alarm fires, fires involving hazardous materials, major spills, leaks, and other significant events that may result in environmental contamination or have a major impact on the operation of City services. Many times the process of handling large-scale fires and associated environmental impacts, especially those involving hazardous materials, is much more involved and time consuming than the actual extinguishment of the fire.

Environmental Sector is responsible for the following:

1. EMERGENCY CONTACTS

The following is a list of contacts that shall be notified and respond to these types of incidents:

- a. Phoenix Fire Department Special Operations Section designee. This person will coordinate the activities of the following agencies and assure communications regarding the event to the Incident Commander & Executive Staff of the Department.
- b. State of Arizona Department of Environmental Quality designee. This person will coordinate the activities to determine air, water or soil contamination and to assure that all environmental issues are identified. This person will also work collectively with Department of Health Services to mitigate conditions caused by environmental issues that are identified. This person will also work collectively with the Department of Health Services to mitigate conditions caused by environmental issues that may adversely affect the public health. This person will also work collectively with the Division of Management and State Emergency Response Commission & Federal Agencies in the coordinating of resources.
- c. City of Phoenix Safety designee. This person will be responsible for safety briefing of City employees other than Fire Department personnel.
- d. City of Phoenix Emergency Management Coordinator. This person will be responsible for the operation of the City's Emergency Operations Center (if applicable) and the functions of this Center.
- e. City of Phoenix Office of Environmental Programs designee. This person will be responsible for tracking the environmental problems associated with the incident as identified by ADEQ and ADHS.
- f. Maricopa County Local Emergency Planning Committee designee. This person will assist in coordination with county agencies for the actions needed to mitigate the event.
- g. State of Arizona Emergency Response Commission designee. This person will assist in coordinating with State and Federal agencies the actions needed to mitigate the event.
- h. State of Arizona Department of Health Services designee. This person will be responsible for matters that affect public health as a result of environmental contamination from an incident.
- i. Maricopa County Health Department, Public Health Director or designee or Director of Epidemiology/Data Services or designee. This person will be responsible for matters that effect public health as a result of environment contamination from an incident.

**PHOENIX REGIONAL
STANDARD OPERATING PROCEDURES**

Environmental Sector

M.P. 201.05D 11/14-R 12/19-SR

2. RESPONSE NEEDS

The severity of the incident will dictate if all these members will be required on site. Special Operations Staff will be assigned by Command to notify the appropriate parties. As appropriate parties are ~~this committee~~ assembled, areas of responsibilities will be further defined as the incident dictates.

3. ACTION PLAN

An action plan will be developed and agreed upon as to what each member will be responsible for and who will be the central point of contact. As information is developed, the agency designated as the central point of contact will inform all the members, and a joint release of information will be made to the public. This information will be real time and updated as often as needed until the event is terminated and all related issues of public concern have been handled.

4. INCIDENT CONCLUSION

At the conclusion of the incident, the members will reassemble and a joint report will be generated regarding all activity involving the incident. In this way, all information will be fully shared amongst all agencies involved in the information gathering and decision making process.

**Flow Chart During HM Incidents
(Environmental Issues)**

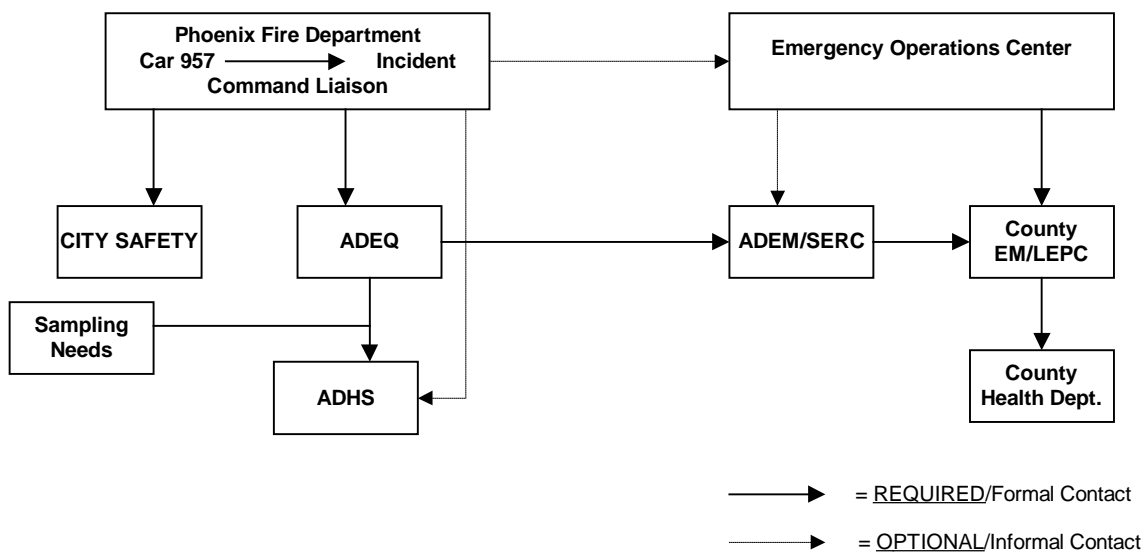

PHOENIX REGIONAL
STANDARD OPERATING PROCEDURES

Environmental Sector

M.P. 201.05D

11/14-R

12/19-SR

Flow Chart After HM Incidents (Environmental Issues)

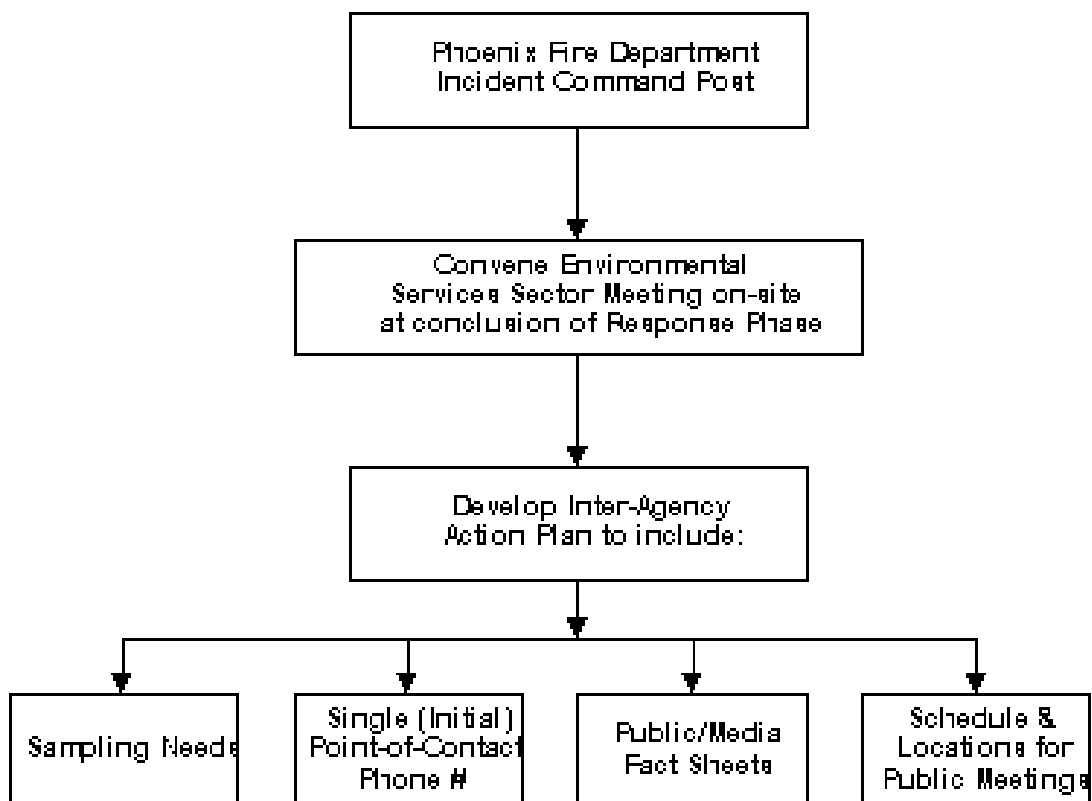

**PHOENIX REGIONAL
STANDARD OPERATING PROCEDURES**

Evacuation Sector

M.P. 201.05E 11/14-R 12/19-SR

PURPOSE

The purpose of this procedure is to provide guidelines to conduct an evacuation of citizens in a geographic area during an emergency incident. The potential for evacuation should be considered during all emergency incidents. The key to an organized and manageable evacuation is to develop an Incident Command System early and initiate a plan and to continually update the plan.

A plan for evacuation should address the following factors:

1. A Command structure
2. Determine the need for evacuation versus in-place sheltering
3. Early notification of the Police Department
4. Identification of an area to be evacuated, perimeters, etc.
5. Required resources
6. Evacuation time frame
7. Identification of shelter sites and preparation of these sites
8. Duration of the evacuation
9. Re-entry of those evacuated
10. Information about the hazard and evacuation presented to evacuees (multi-lingual)
11. Follow-up with evacuees upon re-entry
12. Security of the area evacuated

Other areas which will need to be considered also include:

1. Activation of the Emergency Operations Center (EOC)
2. Assignment of a Police Liaison Sector
3. Communications
4. Media support (PIO)
5. Establishing a Transportation Branch/Sector for evacuees
6. Communicating evacuation plan and shelter sites to the Command organizations of all agencies involved

AREA OF EVACUATION

The area of initial evacuation should be identified by the Incident Commander. The Planning Section will re-evaluate the evacuation area and recommend any necessary adjustments. The evacuation boundaries should follow streets and established roadways. A map should be utilized and distributed to all officers and agencies involved. Maps need to be provided to the Evacuation Branch and the Police Department.

In some situations, in-place sheltering can be used to protect the public rather than initiating an evacuation. In-place sheltering can be considered during the following circumstances:

1. The hazardous material has been identified as having a low or moderate level of health risk
2. The material has been released from its container and is now dissipating
3. Leaks can be controlled rapidly and before evacuation can be completed

**PHOENIX REGIONAL
STANDARD OPERATING PROCEDURES**

Evacuation Sector

M.P. 201.05E 11/14-R 12/19-SR

4. Exposure to the product is expected to be short-term and of low health risk
5. The public can be adequately protected by staying indoors

Command may need to provide instructions to the affected public such as the need to stay indoors shutting down their evaporative cooling systems and closing all doors and windows.

LEVELS OF EVACUATION

There are three levels of evacuation. Each requires a different resource commitment. They include:

1. SITE EVACUATION

Site evacuation involves a small number of citizens. This typically includes workers at the site and people from adjacent occupancies or areas. The citizens are easily evacuated and collected upwind of the perimeter area. Evacuation holding times are typically short, generally less than an hour or two, and citizens are permitted to return to their businesses or homes.

2. INTERMEDIATE LEVEL EVACUATION

The Intermediate Level involves larger numbers of citizens and/or affects a larger area. This level affects off-site homes and businesses and normally affects fewer than 100 people. People may remain out of the area for two to four hours or more. Evacuation completion times will be somewhat longer than a site evacuation but generally rapid. Collecting, documenting and controlling the evacuees becomes more difficult. Off-site collection sites or shelter areas will need to be determined and managed. Some evacuees will leave the area on their own or be sent home by employers. Site perimeters become larger and perimeter security requires more resources. Close coordination with the Police Department and other agencies will be required.

3. LARGE-SCALE EVACUATION

A large or concentrated release of a hazardous substance may cause a large scale evacuation. Thousands of citizens could be evacuated. Rapid initiation of the evacuation process may be required. Evacuees may be out of their homes and businesses for many hours if not days. Evacuation completion time frames will be extended. Evacuation shelters will need to be located, opened and managed. Documentation and tracking of evacuees becomes more important as well as more difficult. Very close coordination with the police and other agencies will be required. Site and evacuation perimeters become extended and require much more resources to maintain. Security of the evacuated area is always a concern. The Emergency Operations Center (EOC) will be activated to support the evacuation and site operations.

There are no precise parameters differentiating one level of evacuation from another. The Incident Commander must implement a Command Organization that meets the needs of each particular incident.

**PHOENIX REGIONAL
STANDARD OPERATING PROCEDURES**

Evacuation Sector

M.P. 201.05E 11/14-R 12/19-SR

DURATION OF EVACUATION

The evacuation should be sustained as long as the risk continues in the evacuated area. Caution should be taken when deciding to allow residents to return to their homes to ensure that the situation is truly under control. Re-evacuating is difficult to complete as many residents will not want to go a second time. It can also be extremely hazardous. Evacuees must be updated with information as soon as possible and periodically throughout the incident.

WHO SHOULD BE EVACUATED

All residents living/working in the area identified should be evacuated. In the event that a resident decides not to evacuate, they should be specifically informed of the risk and, if they still refuse, left to stay. The Evacuation Branch is to be notified and a note of the citizen's address made for further follow-up.

RED CROSS RESPONSIBILITIES

Once long-term sheltering is identified, the Red Cross will manage shelters. Early notification is required. The Red Cross will need up to three hours to get adequate personnel, equipment and supplies to the shelter sites.

SHELTER SITES

When developing the evacuation plan, shelter sites must be identified early. Shelter site selection cannot wait on the Red Cross. Site selection must be made by the Incident Commander at the time evacuation is ordered and sites need Sector officers assigned.

Some Fire department resources will need to be committed to the shelters, particularly in the area of initial opening and staffing by a shelter crew, and later for potential emergency medical support and information management.

A Red Cross representative should be assigned to each shelter. An Occupant Services officer should also be assigned to each shelter.

COMMAND STRUCTURE

The Planning Section is responsible for all planning associated with the evacuation. The evacuation plan is communicated to the Incident Commander for approval or modification. The actual evacuation process would normally be managed in the Operations Section as an Evacuation Branch or Sector. The Evacuation Branch must be provided with sufficient resources to effectively complete the task. Sector assignments within the Evacuation Branch will be assigned as necessary. The following Sections may be implemented:

1. Operations Section
2. Planning Section
3. Logistics Section
4. Administration Section

**PHOENIX REGIONAL
STANDARD OPERATING PROCEDURES**

Evacuation Sector

M.P. 201.05E 11/14-R 12/19-SR

The Planning Section would be responsible for developing an evacuation plan in joint cooperation with the Police Department. Other Sections play a supporting role in the Command Organization. The following Branches may be implemented:

1. Evacuation Branch
2. Transportation Branch
3. Medical Branch
4. Haz Mat Branch
5. Fire Branch
6. Geographic Branches

The Evacuation Branch officer may be a police officer. Branches will be implemented as needed. Branch officers receive the plan and objectives from Command. Branch officers direct sectors in completing the plan and objectives. Separate radio channels will be required.

Sectors to be considered include:

1. Public Information Sector
2. Geographic Sectors (Multiple Sectors)
3. Police Liaison Sector
4. Staging Sector
5. Transportation Sector
6. Shelter Sectors
7. Other Agency Liaison Sectors
8. Other Sectors as necessary

COMMAND RESPONSIBILITIES

Command's responsibilities include the following items:

1. Rapidly size up the situation to determine the need to evacuate
2. Develop Evacuation Plan
3. Request a police supervisor to the Command Post
4. Determine evacuation perimeters
5. Determine the number and location of shelter sites and communicate the locations to the Command organization (Use the CAD INFO SHELTERS or the Yellow Evacuation Manual for shelters and maps)
6. Order evacuation
7. Provide resources required
8. Establish police liaison; request a ranking police officer to the Command Post
9. Provide a ranking fire officer to the police liaison officer/Police Command Post
10. Order the alert of other appropriate agencies
11. Expand the Command organization to meet the incident/evacuation needs
12. Establish an evacuation plan and communicate the plan to Branches, Sectors and agency liaisons

**PHOENIX REGIONAL
STANDARD OPERATING PROCEDURES**

Evacuation Sector

M.P. 201.05E 11/14-R 12/19-SR

13. Monitor, support and revise the evacuation process as necessary
14. Evacuate persons from the greatest danger first
15. Assign specific areas to evacuate in order to avoid duplication or missed areas [use Fire department map book - either page numbers (e.g., NE0107) or hydrant zone numbers as grids]
16. Provide the transportation necessary for evacuees
17. Provide continuing command of the evacuation, de-commitment and return of evacuees
18. Determine the need to implement a unified command structure involving other agencies (this would depend upon the nature of the incident)

COMMUNICATIONS

A separate radio frequency should be used for the Evacuation Branch. This should be assigned as early in the incident as possible.

DISPATCH AND DEPLOYMENT RESPONSIBILITIES

1. Dispatch appropriate resources as requested
2. Notify the appropriate Fire and City officials
3. Notify the appropriate support agencies as requested or listed in Standard Operating Procedures
4. Initiate recall of additional Dispatch staff to meet the demands of the incident
5. Notify the City telephone switchboard operator and provide the operator a status report. Update the operator as needed
6. Notify the hospitals in the area of evacuation (both those exposed and not exposed) and provide a status report and updates as needed (intermediate and large-scale evacuations)
7. Update Fire Administration staff of the status of the incident if it is during normal business hours (they will receive many calls from citizens requesting information)

PUBLIC INFORMATION OFFICER'S RESPONSIBILITIES

1. Establish PIO Sector
2. Notify the news media and provide status reports and updates as necessary
3. Provide the media with consistent and accurate evacuation instructions as provided by Command
4. Utilize the media and coordinate evacuation notices through news media

MEDIA SUPPORT

The incident PIO should be informed of the evacuation plan so that the media is aware of the areas to be evacuated, shelter sites and any evacuation instructions to the public. The PIO should make every effort to assemble the media at the scene to keep them away from hazards and out of the evacuation area. Residents may receive information from the media during the evacuation, so it is critical that the media information be accurate.

Also needed is a single phone number that should be released to the public for information.

**PHOENIX REGIONAL
STANDARD OPERATING PROCEDURES**

Evacuation Sector

M.P. 201.05E 11/14-R 12/19-SR

POLICE LIAISON

A police representative will need to be assigned to the Planning Section and another to the Evacuation Branch as a liaison. The police liaisons will communicate with the Police Incident Commander and keep other parties in the Police Department informed of the plan, progress, etc.

POLICE RESPONSIBILITIES

The Police Department will be an integral part of the evacuation process, as a large portion of the evacuation is usually accomplished by the Police Department. Police responsibilities include:

1. Provide a ranking officer to the Incident Command Post
2. Provide a ranking officer to the Evacuation Branch/Sector
3. Develop a Police Incident Command System to manage police operations
4. Provide a communication system for police resources
5. Provide police resources needed for evacuation
6. Provide traffic control and traffic routing
7. Provide perimeter security
8. Provide evacuation zone security
9. Identify transportation needs

EVACUATION BRANCH RESPONSIBILITIES

On large-scale evacuations, a Branch level position on a separate radio channel will be necessary. Sectors will also need to be established and report to the Evacuation Branch officer.

Typically, a large commitment of police officers will be required to accomplish an evacuation. The Evacuation Branch officer may be either a police or fire officer. The Evacuation Branch must obtain a ranking police official at his/her location in order to closely coordinate evacuation efforts. An appropriate commitment of police resources must be obtained. Evacuation responsibilities include:

1. Obtain resources needed to evacuate
2. Obtain ranking police officer as liaison
3. Provide a ranking fire officer to serve as or support the Branch officer
4. Establish Sectors as needed
5. Provide Sectors objectives and specific areas to evacuate (use Fire department map pages or hydrant zones in Fire department map book for grids)
6. Provide Sectors with shelter location and instructions
7. Provide Sectors with evacuation instruction pads and written evacuation information for evacuees if possible (consider needs for multiple languages)
8. Provide Sectors with private vehicle routing instructions (out of the area)
9. Obtain/provide ambulances, buses or other transportation to those requiring transportation out of the area
10. Evacuate those at greatest risk first

**PHOENIX REGIONAL
STANDARD OPERATING PROCEDURES**

Evacuation Sector

M.P. 201.05E 11/14-R 12/19-SR

11. Evacuate the greatest concentrated areas next (e.g., apartment complex)
12. Consider individual Sectors for large population occupancies (e.g., multi-story buildings, large apartment complexes, schools, etc.)
13. As individual geographic or grid Sectors complete their evacuations, terminate the Sector identity and reassign resources to other developing Sectors (for large-scale evacuation)
14. Closely document and maintain records of the evacuation process to avoid duplication or missed areas
15. Document those addressees and times for those refusing to leave

INFORMATION AND NOTIFICATION

The Police Department and fire companies should be used for resources/staffing to conduct a walk-through or drive-through in the area to be evacuated. Fire companies should be assigned to hazardous areas with police assigned to safe areas. The officers should provide residents with information about the situation and be told that they are being evacuated, to where, and why. It is necessary to inform the residents of shelter areas being established to minimize confusion and anxiety.

ON-SITE NOTIFICATION TO EVACUATE

Door-to-door notification is time-consuming. In many cases, adequate resources and time is not available to do this type of face-to-face notification. Use of sirens, air horns and PA systems will speed the alert process.

When making door-to-door evacuations:

1. Be in uniform
2. Wear your helmet

Face-to-face notification should include the following instructions:

1. There is an emergency
2. You are in danger
3. Leave immediately
4. Go to shelter (location)
5. Take (____) route out of area
6. Do you need transportation?
7. Consider multi-lingual needs

Evacuees should be advised to take the following items:

1. Wallet/purse
2. House and car keys
3. Money
4. Eyeglasses
5. Medications
6. Proper/warm clothing
7. Family pet

In other situations, where immediate and rapid evacuation makes door-to-door notification impossible, use the following notification method:

**PHOENIX REGIONAL
STANDARD OPERATING PROCEDURES**

Evacuation Sector

M.P. 201.05E

11/14-R

12/19-SR

1. Use three (3) five-second blasts of the siren while on the "YELP" setting
2. Follow with the standard evacuation instruction over PA system (see instructions above)
3. Use maximum volume on PA system
4. Proceed slowly to maximize notification
5. Initiate notification at the beginning of each block and each 50 yards after that

****Once each assigned grid of objectives is complete, report completion to the Evacuation Branch/Sector Officer****

An information phone line may need to be set up to provide an information source for citizens with concerns about the incident. This information would be for family members affected by the evacuation or medical information for Haz Mat incidents and general information about the evacuation.

REFUSAL TO LEAVE

Evacuations follow somewhat of a triage philosophy; we will evacuate the greatest number for the greatest benefit. Individual refusals will be left to fend for themselves. There simply may not be enough time or resources to initiate forced removal of persons from their homes. However, documentation of the refusal should be done. Write the address down (or if radio traffic permits, radio the address to the Evacuation Branch). A few methods of persuasion include:

1. Be in uniform
2. Wear your helmet
3. Wear SCBA and facepiece (air hose may not need to be connected) when advising the citizen to leave
4. Ask for next of kin and a phone number
5. Write the next of kin information down
6. Refusals should be noted and reported to the Branch Officer by radio

TRANSPORTATION BRANCH/SECTOR

A Transportation Sector should be established within the Evacuation Branch. Ambulances and other transport vehicles should be staged in the event that a citizen may need transportation to a shelter or other location. Non-ambulatory people must be located and information provided to the Transportation Sector so that they are not overlooked in the evacuation. Transportation Branch/Sector responsibilities include:

1. Obtain buses (start with a minimum of two) and other vehicles that can be used for transportation
2. Stage all transportation resources
3. Put one firefighter (or police officer) on each vehicle equipped with a fire or police department radio
4. Coordinate the Evacuation Sector (or Evacuation Branch) pick-up points or addresses of those citizens needing transportation

**PHOENIX REGIONAL
STANDARD OPERATING PROCEDURES**

Evacuation Sector

M.P. 201.05E 11/14-R 12/19-SR

EMERGENCY OPERATIONS CENTER (EOC)

If a significant or major evacuation occurs, the City's Emergency Operations Center (EOC) will be activated. The EOC will collect department heads and senior staff from the Fire, Police, City Manager's office, Public Works and other City departments to the EOC. The EOC's objective is to use the City's resources to support the incident.

Command should be prepared for this support and potential policy direction in regards to the incident and evacuation operations.

If the EOC is in operation, the Planning Section is responsible for briefing and maintaining communication with the EOC. A radio communications link (another radio channel) with the EOC and a cellular telephone link may be required. If the EOC has a CAD terminal, the EOC liaison will need access to an MCT. Responsibilities of the Planning Section's EOC Liaison Officer are:

1. Obtain a radio communications link with the EOC (through Dispatch Headquarters on a separate channel)
2. Obtain a cellular telephone or other communications link with the EOC (City of Phoenix EOC phone numbers: 262-6100, 262-6664, 262-7293)
3. Obtain an immediate status report from Command and provide that report to the EOC Fire Officer
4. Provide an immediate report to the EOC on any changes in plans, strategy, problems encountered, etc
5. Provide progress reports every 30 minutes unless the EOC requires more frequent reports
6. Act as the communications link from EOC to Command
7. Provide Command with direction, policy information, etc., that is communicated from the EOC

Once established, the EOC will usually remain in operation for the duration of the evacuation. Command will maintain an EOC liaison and a communication link with the EOC throughout the evacuation, including decommitment and return of evacuees.

RETURN EVACUEES

The decision to return evacuees to their homes will be the sole responsibility of the fire department Incident Commander. If the EOC is operating, the decision to return evacuees will be made by the EOC staff. No other City agency will be authorized to order the return.

The Planning Section will jointly develop a return plan for evacuees.

Returning evacuees may require some transportation be provided. A Transportation Sector should be reactivated to organize these needs.

**PHOENIX REGIONAL
STANDARD OPERATING PROCEDURES**

INFORMATION SECTOR

M.P. 201.05F 09/98-R Page 1 of 2

INTRODUCTION

It is the policy of the Phoenix Fire Department to establish and maintain a positive working relationship with the media.

This directive will establish a standard operating procedure to provide the media with information normally requested from the Fire Department on emergency incidents, to monitor the movements of media personnel for safety reasons, and to establish an operating framework for an Information Sector that will effectively integrate into the overall incident management system.

STANDARD OPERATING PROCEDURE

Command will be responsible for the assignment of an Information Sector on the fireground or any significant incident. As soon as practical, after basic rescue and fire operations are extended, Command will establish an Information Sector. The establishment of this sector will relieve Command of the responsibility of dealing directly with the media during critical Command stages and provide standard information the media will require to accurately report the emergency.

The Public Information Officer (PIO) will report to Command, upon arrival, and establish an Information Sector if not already established.

NOTE: If a fire company or other fire department member has been assigned Information Sector responsibilities the PIO will report to the sector location, receive a briefing from the sector officer, and assist as needed. The PIO may assume sector responsibilities at his/her discretion.

Radio designation will be "Public Information Sector."

Individuals assigned to perform this sector function should consider the following general guidelines:

Basic Information:

- A. Timely response
- B. Number of units and personnel on-scene
- C. Human Interest or Safety Information

If possible, add anything to the basic information that will enhance the story; such information might include:

- A. Highly skilled and trained professionals (high rise, technical rescue, etc.)
- B. An extremely hazardous situation
- C. A person or company that did an outstanding job on or off duty fire fighter involvement
- D. A rescue scenario
- E. Projected duration of incident

**PHOENIX REGIONAL
STANDARD OPERATING PROCEDURES**

INFORMATION SECTOR

M.P. 201.05F

09/98-R

Page 2 of 2

- This information will assist the reporters in their coverage of the incident and enhance the quality and accuracy of their stories.
- When possible, an interview with the company officer or crewmember is encouraged. Don't be afraid to talk to reporters. They will report the facts you give them.
- Every effort should be made to provide accurate information.

Usually, while gathering information, you will have inquiries from reporters. Provide the information you have at that point and emphasize that this information is preliminary. If it gets to the point that questions from reporters are keeping you from gathering information, use these alternatives:

1. Tell the reporters to gather in one place and that you will return shortly with more information.
2. Request additional manpower from Command to assist in gathering information and remain with the reporters.
3. Tell the reporters to go ahead and get pictures and film footage without interfering with incident operations while you are gathering information. Certified Fire Journalists (CFJ), identified by their green helmets and fire journalist identification, may be assigned to sectors. Journalists without green helmets or the proper CFJ identification will not be assigned to a sector and will be required to remain outside the incident perimeter. Make sure and point out the hazard zone. Arrange to meet with them shortly and give them any additional or updated information.
4. If they have deadlines to meet, get a phone number(s) where they can be reached and phone them as soon as possible.
5. **BEFORE RELEASING NAMES OF PERSONS SERIOUSLY INJURED OR DECEASED CONFIRM THAT NEXT OF KIN HAS BEEN NOTIFIED.** Notifications are usually handled by police and/or hospitals. Ask the Dispatch supervisor to check with PD or hospital to confirm that next of kin has been notified. **DO NOT USE THE NAMES OF DECEASED OR SERIOUSLY INJURED PERSONS IN YOUR INTERVIEW OR OVER THE RADIO UNTIL NOTIFICATION OF NEXT OF KIN HAS BEEN CONFIRMED.** Ask for assistance from the PIO office.
6. Do not speculate as to the cause of a fire or car accident.

The individual or company assigned to the Information Sector may be required to escort the media on a tour of the fire damage area following knockdown. This must be cleared with Command and coordinated with operating sectors prior to entering the area.

The Information Sector will be responsible for insuring that all media personnel wear proper protective clothing on the fireground or any other area when needed.

Each Sector Officer is responsible for the safety of media personnel in the area. If media personnel create a safety problem, or hinder operations, they will be requested to move. **AVOID CONFRONTATIONS!** The policy of the Department is to cooperate with the media.

**PHOENIX REGIONAL
STANDARD OPERATING PROCEDURES**

CRITIQUE SECTOR/INCIDENT ANALYSIS

M.P. 201.05G

03/02-R

Page 1 of 14

Post-incident critiques of major and significant incidents provides an opportunity to review the effectiveness of actions and procedures in their application during actual incidents. It is also an opportunity to review the overall quality of the services provided to the customers at the incident. This review is extremely valuable in improving procedures and incident operations. Formal departmental critiques will be conducted at the discretion of the Tactical Services Chief.

Critique Sector--Implementation

An incident Critique Sector may be utilized at major incidents. This sector will be implemented automatically by the Training Academy officer responding to the incident. Command must be notified of the Critique Sector's establishment. In the absence of an Training Academy officer, the Tactical Services chief or the Incident Commander will designate a fire officer to implement this Sector.

A critique "team" may also be implemented as part of the Critique Sector at greater alarms, or other significant incidents at the request of Command, to prepare and conduct a critique. Command must be notified of the Critique Sector's establishment. The Tactical Services Chief, or his/her designee, will select team members and make critique assignments.

Critique--Sector Responsibilities

The responsibilities of the Critique Sector will be:

- * Produce a drawing of the incident layout and other details needed for a critique. This includes a drawing of the building or incident site with appropriate dimensions, apparatus placement, size and positions of hose lines and master streams, accountability locations, etc.
- * Provide descriptive notes of observations related to actions and effectiveness of companies and sectors, unique problems, etc.
- * Coordinate and ensure the photography/videography of the incident by the fire department personnel.
- * Complete/Coordinate any other request of the Incident Commander, or operations officer as related to critique preparation.

Post-Incident Preparation

Post incident preparation for a critique will begin immediately following a major incident. The shift commander or battalion chief will determine the need for a critique and initiate the post-incident preparation once the incident is identified as one which will be critiqued. The Tactical Services Section will assist in gathering information and coordination of the critique.

Determining Critique Levels

The incident may qualify for one of five levels of critique. The Assistant Chief of Operations, or designee, will determine the level at which the incident will be critiqued. The Tactical Services Section will coordinate and/or conduct the critique.

**PHOENIX REGIONAL
STANDARD OPERATING PROCEDURES**

CRITIQUE SECTOR/INCIDENT ANALYSIS

M.P. 201.05G

03/02-R

Page 2 of 14

1. Individual--Conducted within the individual company by the company officer. May include other companies. Usually self initiated by the company officer. No documentation of the critique required.
2. Company Level--Post-incident critique conducted on site, prior to departing the scene. Initiated by Command or battalion chief. Informal and brief.
3. Battalion Level--Initiated and organized by the battalion chief. Scheduled assembly of the necessary companies as soon as possible after the incident. Structured critique format. Battalion chief completes critique analysis form and forwards to the Tactical Services Section.
4. Operations Level--Conducted within the battalion by the battalion chief or Shift Commander. This may be a first alarm or multiple-alarm incident, or other significant incident whose site operations were uncomplicated, and generally did not involve a large response of fire department resource or outside agencies. A standard critique packet will be utilized to prepare for and conduct the critique. A critique summary will be completed. All critique materials and documents will be forwarded to the Tactical Services Section for filing.
5. Department Level--Utilized for critiquing large-scale or complex incidents that involved a large response of fire department resources and several outside agencies or incidents that were unusual or tactically significant occurrences. A chief officer will be selected to prepare and conduct the critique. A team may be assigned to assist also. A standard critique packet will be utilized to prepare for and conduct the critique. A critique summary will be completed. All critique materials and documents will be forwarded to the Tactical Services Section. The Tactical Services Section will be responsible for coordinating the date and location of department level critiques and making Buckslip and other notifications.

This critique will require greater coordination, investigation, and preparation. It will be conducted at a selected location to accommodate a large attendance.

Critique Preparation Packet

Since a major incident affects all divisions and sections of the department in one degree or another, the operations and department level critique will review the total incident response rather than just simply the site operations aspects of the incident. A thorough critique of major incidents may require the assistance of several divisions or sections. Therefore, the following Divisions and Sections will be asked to submit at least the following information/materials. Turnaround for submitting the information to the Tactical Services chief will be ten (10) calendar days.

Urban Services--Code Enforcement Section

- * Submit a summary of the building fire inspections history and history of fire code violations, including a list or a summary of the number and types of Certificates of Occupancy's that have been issued and any building alterations or other modifications that have been made.
- * Ensure and provide site photography, including aerials as needed.
- * Provide slide/photograph processing and duplicating (10 working-day turnaround).

Resource Management---Responsibilities

- * Provide summary of incident observations and response.
- * Provide a summary of Resource Management's response (who responded and on-scene actions).

**PHOENIX REGIONAL
STANDARD OPERATING PROCEDURES**

CRITIQUE SECTOR/INCIDENT ANALYSIS

M.P. 201.05G

03/02-R

Page 3 of 14

- * Provide a summary of any sector or Section responsibilities assumed and their effectiveness (i.e., Rehab sector, water supply, Logistics Section etc.).
- * Submit a summary determination as to whether the building met the current fire code, and if not, what requirements were needed to meet the code. Also indicate any code requirements that the fire building is required to meet as an existing building/fire code.
- * Provide a summary analysis of the building, describing the type of structure, type of roof structure, etc., and the affect of fire on the structure and systems.

Urban Services--Investigations Section

- * Provide a summary report identifying the point of origin, type of ignition (i.e., accidental electrical, suspicious flammable liquids, etc.).
- * Provide a brief description of type and route of fire spread. Specifically, if the building did not collapse, identify locations within the structure that were compromised and near collapse, or presented other hazards to firefighters.
- * Provide building value and loss figures.
- * Provide a summary of the fire protection and detection systems in the building and the effectiveness of those systems during the fire.
- * Provide a list of fire protection and detection systems, or building designs, that were not provided, that would have reduced life loss, injury, or would have reduced property loss (this list shall not be restricted to current code required features).
- * Provide information as to whether the fire may have been related to other fires.
- * Provide a follow-up report by the critique date on additional information (releasable) on the investigation.
- * Provide releasable photographs or slides and/or video taken by investigators that may be helpful to the critique process.

Training Academy--Responsibilities

- * Responds to major incidents for training needs, evaluation, and establish the critique sector.
- * Provide site drawings of incident layout, apparatus positioning, attack line placement, accountability locations, etc.
- * Provide a summary description of equipment or apparatus performance, repairs, refueling, etc.

Corporate Communications--Responsibilities

- * Provide incident video.
- * Provide collection of appropriate news media video, photographs, etc.
- * Provide editing/production of critique video.
- * Provide graphic slide or transparency production.

Dispatch and Deployment--Responsibilities

- * Provide audio tapes (2 copies) of the phone reports, dispatch, and tactical channel operations through to the report of fire control. Forward to Tactical Services.
- * Provide incident history printout. Forward to Tactical Services.
- * Conduct an in-house critique of dispatch and alarm activities during the incident.
- * Provide a summary of Dispatch and Deployment critique and incident activities, identifying such items as call-back of personnel, equipment or activity problems, number of other incidents dispatched, etc., and any lessons learned from the in-house critique. Forward to Tactical Services.

**PHOENIX REGIONAL
STANDARD OPERATING PROCEDURES**

CRITIQUE SECTOR/INCIDENT ANALYSIS

M.P. 201.05G

03/02-R

Page 4 of 14

Safety--Responsibilities

- * Provide a summary of incident observations of safety related issues.
- * Provide a summary of firefighter injury history, patient follow-ups.
- * Provide a list of recommended corrective actions.

Emergency Medical Services Section--Responsibilities

If the incident involves multiple patients:

- * Provide a summary of the EMS sections response and incident evaluation.
- * Provide a summary on patient distribution by hospital, number of patients to each, triage category at site, hospital priorities, etc.
- * Provide a summary of triage tagging effectiveness & accuracy based on patient follow-up.
- * Provide follow-up report summary on patient injuries, expected outcomes, etc.
- * Provide lessons learned from any in-house critiques of EMS operations.

Special Operations Section--Responsibilities

If the incident involves a response of special operations resources:

- * Provide a summary of Special Operations Section response and evaluation by section officer.
- * Provide a summary of site operations/actions by special operations units.
- * Provide a summary of hazardous materials present, their hazards to fire fighters, and suggested incident management and procedures.
- * Provide copies of DOT Guidelines and other related literature and reference material for product(s) involved.
- * Provide a summary of cleanup operations.
- * Provide lessons learned from any in-house critiques of Special Operations incident activity.

Battalion Chief's--Responsibilities

- * Initiate Critique Process
- * Provide a summary of observations, problems, actions, and activities encountered.
- * Provide a summary of responsibilities and activities and their effectiveness from each sector.
- * Complete an incident analysis form (#) and submit it to the Tactical Services chief where appropriate.
- * Provide recommendations as appropriate.
- * Provide photographs/slides/video taken by Field Incident Technicians.

Field Incident Technician Responsibilities

- * The Field Incident Technician of the Incident Commander, or designated critique officer, is responsible for the following.
- * Assist Battalion Chief/Shift Commander in preparing critiques.
- * Immediately collect all slide film, including film shot by other FIT's, for rush processing.
- * Immediately provide all video tape, including video from other FIT's.
- * Immediately send out CAD critique questions using the Battalion/Shift Commander CAD Terminal. Questions should be sent to all companies involved and returned to the Battalion/Shift Commander printer.

**PHOENIX REGIONAL
STANDARD OPERATING PROCEDURES**

CRITIQUE SECTOR/INCIDENT ANALYSIS

M.P. 201.05G

03/02-R

Page 5 of 14

Field Incident Technician Responsibilities

- * Initiate the mailing, through department mail of the critique packet request for critique information to the appropriate identified sector officers, and designated divisions and sections. This material should be returned to the sending battalion or Shift Commanders office.
- * Collect all tactical worksheets and other drawings.
- * Coordinate, with the Incident Commander, a drawing of the organization chart, using the diagram in the critique packet.

Shift Commander's--Responsibilities

- * Initiate/support Critique Process
- * Provide a summary of observations, problems, actions, activities encountered.
- * Complete an incident analysis form and submit it to the Tactical Services chief where appropriate.
- * Provides recommendations as appropriate.

Tactical Services Section - Responsibilities

- * Responds to incident for incident evaluation and analysis.
- * Initiates critique process once critique level is determined.
- * Field Incident Technician distributes/collects critique packet information requests to/from Divisions and Sections.
- * Collects critique materials (i.e., slides, information requests, etc.).
- * Meets with Shift Commander and Incident Commander to review incident and prepare critique materials.
- * Provides selected critique officer with critique packet and materials.
- * Battalion Chief/Shift Commander coordinates critique presentation notifications with affected shift commanders, as needed.
- * Coordinates time and location of critique.
- * Assists as needed with critique preparation/presentation.
- * Collects post-critique materials, lessons learned.
- * Coordinates the final drawing of site layouts, etc.
- * Prepares critique review training package.
- * Publishes results of critique lessons learned for company review and entry into Volume 8.
- * Maintains file of all critique materials and lessons learned.
- * Initiates changes in procedures, plans, equipment, etc.

Critique Officer--Responsibilities (Selected Chief officer)

- * Review CAD - L.O.C. information on building.
- * Determines if building is in CAD, if information is complete and accurate; makes appropriate updates.
- * Obtains a hard-copy printout of CAD L.O.C. history for critique.
- * Reviews collected critique materials.
- * Prepares critique presentation materials.
- * Works with the Tactical Services Chief and Shift Commander in preparing and conducting critique.
- * Conducts the critique.
- * Provides Tactical Services Chief with lessons learned.
- * Prepares a critique summary with lessons learned.
- * Returns all critique materials to Tactical Services Chief.

**PHOENIX REGIONAL
STANDARD OPERATING PROCEDURES**

CRITIQUE SECTOR/INCIDENT ANALYSIS

M.P. 201.05G

03/02-R

Page 6 of 14

Critique Package--Collected Materials

Once all requested summaries and other materials are returned to the Tactical Services Chief, they will be forwarded to the selected critique officer as a critique package.

Critique Presentation Scheduling

All Divisions, Sections, and Command officers from other departments will be notified of a department-level critique via a Buckslip/e-mail notification. The Tactical Services Section will initiate the notice. Shift Commanders will coordinate the scheduling of selected companies and personnel to the critique in their affected districts.

For operations-level critiques, the affected Shift Commander and battalion chief will be responsible for coordinating the scheduling and attendance of selected personnel and companies.

Critique Presentation Format

In order to provide consistency in the critique process, the critique officer should follow the standard format when conducting the critique. Modifications and additions in the format are permitted.

Incident Critique Summary

Following the critique, the Critique Officer is responsible for completing the critique summary. This is a two-three page written summary of the event and lessons learned. The written summary, plus a drawing of the incident site, must be completed. This summary is used for training purposes and a final copy will be issued to Volume 8 (see page 16 for summary outline). All data, and other materials used to prepare for and conduct the critique must be forwarded to the Tactical Services Section within 10 days of the critique.

Company-Officer Critique Review

Company-level critique review will be presented to all company officers on a regular basis throughout the year. The objective of the critique review is to provide the follow-up training of lessons learned to all company and Command officers of the department.

The Tactical Services Section will prepare the Critique Review Training Packet. The training packet will include video, slide, transparency, and other materials emphasizing lessons learned. The Tactical Services Chief, or his designee, will conduct the critique review at quarterly company officer meeting.

**PHOENIX REGIONAL
STANDARD OPERATING PROCEDURES**

CRITIQUE SECTOR/INCIDENT ANALYSIS

M.P. 201.05G

03/02-R

Page 7 of 14

CAD Questionnaire

CRITIQUE QUESTIONS--FIRES

Please respond to the following critique questions and send your responses to (List the Battalion/District printer code). There is no need to rewrite the question, just use the corresponding number for your response. Respond by the end of today's shift. Thank you for your help.

The questions are for the:

Incident # _____ Address

1. Describe the conditions of the emergency upon your arrival.
2. Describe your actions or assignments.
 - A. If you laid a supply line, from where to where?
 - B. If you used an attack line, what was it's original size?
If it changed in size, what size was used after the change?
 - C. Where were your attack lines (streams) deployed?
3. If you were a sector officer, identify the sector and describe the objectives of your sector.
4. Identify and describe any unique problems you may have encountered.
5. Describe any events or actions at this emergency that assisted you in accomplishing your objectives or tasks.
6. Describe any events or actions at this emergency that may have hindered you in accomplishing your objectives or tasks.
7. Did you encounter any SAFETY problems? If so, identify.
8. Did you experience any equipment failures? List/Describe failures.
9. What would you do differently the next time?
10. Any recommended changes in plan, procedures, training, or equipment as a result of this incident?

**PHOENIX REGIONAL
STANDARD OPERATING PROCEDURES**

CRITIQUE SECTOR/INCIDENT ANALYSIS

M.P. 201.05G

03/02-R

Page 8 of 14

CRITIQUE PRESENTATION FORMAT--STRUCTURAL FIRES

- Critique should be limited to a maximum of 1 to 1-1/2 hours in duration if possible.
 - Conflict should be moderated by the Critique Officer so that the critique remains a productive learning experience.
- I. Introduction
 - a. General introduction on the incident
 - b. Unique circumstances/problems, etc.
 - c. Review Tactical Preplan information
 - II. Building Structure/Site Layout
 - a. Review type of structure, and post-incident structure analysis, or incident site layout.
 - III. Review Fire Code History
 - a. Review code requirements, deficiencies etc., as applicable.
 - b. Review file history on building alterations, inspections, etc.
 - IV. Dispatch and Response
 - a. Play tapes of reporting, dispatch, on scene reports
 - b. Analyze dispatch, on scene reports
 - c. Was dispatch appropriate for nature of reports?
 - V. Site Operations
 - a. Analyze structural integrity of building based fire conditions on arrival, at 10 minutes, at 20 minutes, at 30 minutes
 - b. Review/analyze size-up decisions by Command
 - c. Review/analyze strategy/action plan
 - d. Review/analyze offensive/defensive decisions by Command
 - e. Review risk analysis applied to the incident
 - f. Review/analyze sector operations
 - g. Review/apparatus positioning
 - h. Review attack line selection/positioning, etc.
 - i. Review ventilation operations
 - j. Review loss control operations
 - k. Review night time and interior lighting operations
 - VI. Rescue Sector
 - a. Review/analyze Sector activities
 - b. Review apparatus positioning
 - c. Review hoseline selection
 - d. Review search plan
 - e. Review rescue plan
 - f. Discuss problems encountered

**PHOENIX REGIONAL
STANDARD OPERATING PROCEDURES**

CRITIQUE SECTOR/INCIDENT ANALYSIS

M.P. 201.05G

03/02-R

Page 9 of 14

- VII. Staging
 - a. Early Level II
 - b. Location adequacy
 - c. Communications
 - d. Site Access

- VIII. Communications
 - a. Review dispatch and deployment functions during incident
 - b. Review/analyze the communication process
 - c. Did Command receive adequate, accurate and timely information?
 - d. Did Command effectively communicate his/her plan, objectives and other information to sectors/companies?
 - e. Did sectors effectively communicate plans, objectives and other information to companies?

- IX. Support Functions
 - a. Review rehab operations
 - b. Review equipment/apparatus failures, repairs
 - c. Review water supply

- X. Safety Sector
 - a. Discuss safety aspects of incident
 - b. Review injuries, causes, etc.
 - c. Review corrective actions

- XI. Accountability
 - a. Discuss fireground accountability
 - b. Determine if accountability was accurate
 - c. Were accountability locations easily identified
 - d. Have Accountability officers describe accountability operations, problems
 - e. Discuss, Review Accountability Sector operations
 - f. Accountability Benchmarks

- XII. Investigations
 - a. Review cause, point of origin, fire spread
 - b. Update on investigation

**PHOENIX REGIONAL
STANDARD OPERATING PROCEDURES**

CRITIQUE SECTOR/INCIDENT ANALYSIS

M.P. 201.05G

03/02-R

Page 10 of 14

**PRESENTATION
CRITIQUE FORMAT--MAJOR MEDICAL**

- Critique should be limited to a maximum of 1 to 1-1/2 hours in duration if possible.
- Conflict should be moderated by the Critique Officer so that the critique remains a productive learning experience.

I. Introduction

- A. General Introduction
- B. Unique circumstances, problems, etc.

II. Scene Operations

- A. Unique Problems
- B. Situation on arrival, 10 minutes, 20 minutes, 30 minutes
- C. Size-up
 - 1. Early call for assistance
 - 2. Updates/progress reports
 - 3. Action plan updates/progress reports
- D. Plan of action/strategy
- E. Command Operations
- F. Sector Operations
 - 1. Scene safety, extrication, treatment, transportation, staging, occupant services, AR vans
- G. Scene arrangement/layout
 - 1. Sectors, apparatus positions, lighting, rescue access, loading points, obstacles, barriers
- H. Outside Agencies
 - 1. Private Ambulance
 - 2. Hospitals
 - 3. Police
 - 4. City Transit
 - 5. Medical Examiner
 - 6. Airport

III. Communications

- A. Dispatch, On-scene reports
- B. Dispatch and Deployment Operations
 - 1. Notifying hospitals, outside agencies
 - 2. Progress Reports
 - 3. Problems encountered
- C. Transportation Sector Communications/Coordination

**PHOENIX REGIONAL
STANDARD OPERATING PROCEDURES**

CRITIQUE SECTOR/INCIDENT ANALYSIS

M.P. 201.05G

03/02-R

Page 11 of 14

IV. Support Functions

- A. Safety Sector
- B. Rehab Sector
- C. Resource Management - Equipment/Supplies

V. Staging Operations

- A. Early Level II?
- B. Rescues
- C. Fire Apparatus
- D. Other agencies

VI. Triage/Patient Outcomes

- A. Accuracy of Triage Decisions
- B. Appropriate Treatment & Packaging

VII. Conclusion

- A. Patient Follow-ups/Outcome
- B. Department Medical Physician - Review/Input
- C. Lessons Learned
- D. At-A-Boy's

**PHOENIX REGIONAL
STANDARD OPERATING PROCEDURES**

CRITIQUE SECTOR/INCIDENT ANALYSIS

M.P. 201.05G

03/02-R

Page 12 of 14

CRITIQUE PRESENTATION FORMAT--HAZARDOUS MATERIALS

- Critique should be limited to a maximum of 1 to 1-1/2 hours.
- Conflict should be moderated by the Critique Officer so that the critique remains a productive learning experience.

I. INTRODUCTION

- A. General introduction on incident
- B. Unique circumstances/problem, etc.
- C. Review Tactical Preplan information

II. SITE REVIEW

- A. Review type of structure and post incident structure analysis as appropriate, or site layout review
- B. Review storage/Interior – Exterior
- C. Review type of container/transport involved
- D. Review roadway location, access, drainage
- E. Review storm drains and sewer systems
- F. Review weather conditions

III. FIRE CODE HISTORY

- A. Review code, laws, regulations and deficiencies
- B. Review file history on building alternatives, inspections, citations, etc.
- C. Review file on spill history

IV. DISPATCH AND RESPONSE

- A. Play tapes of reporting, dispatch, on scene reports
- B. Analyze dispatch, on scene reports
- C. Dispatch adequate for nature of reports?

V. SITE OPERATIONS

- A. Analyze structural/container integrity, based on arrival conditions, at 10 minutes, at 20 minutes, at 30 minutes, etc.
- B. Analyze the spill/release conditions at 10 mins, 20 mins, 30 mins, etc.
- C. Review/analyze size-up decisions by Command
- D. Review/analyze strategy/plan
- E. Review/analyze offensive/defensive decisions by Command
- F. Discuss risk analysis
- G. Review/analyze sector operations
- H. Review apparatus positioning
- I. Review ventilation operations
- J. Initial action by first responder
- K. Initial action by HIRT units
- L. Did HAZ MAT sector establish all necessary sub-sectors?
- M. Review/analyze evacuation process

**PHOENIX REGIONAL
STANDARD OPERATING PROCEDURES**

CRITIQUE SECTOR/INCIDENT ANALYSIS

M.P. 201.05G

03/02-R

Page 13 of 14

- VI. Staging
 - A. Early Level II
 - B. Location adequacy
 - C. Communications
 - D. Site Access

- VII. HAZ MAT OPERATIONS
 - A. Review product identity process
 - B. Review product fire, explosive, and health risk
 - C. Review product containment and control measures
 - D. Review entry and Hazard zone operations
 - E. Review clean-up process
 - F. Review weather monitoring
 - G. Review decontamination measures/practices
 - H. Review research data used
 - I. Review instrumentation measures/practices

- VIII. AGENCY COORDINATION
 - A. Review outside agency response
 - B. Review agency coordination and usage at incident

- IX. COMMUNICATIONS
 - A. Review/analyze the communication process
 - B. Did Command receive adequate, accurate and timely information?
 - C. Did Command effectively communicate his/her plan, objectives and other information to sectors/companies?
 - D. Did sectors effectively communicate plans, objectives and other information to companies?
 - E. Did Command request appropriate information from Haz sector to develop a plan of action?

- X. SUPPORT FUNCTIONS
 - A. Review Dispatch & Deployment functions during incident
 - B. Rehab operations
 - C. Equipment/apparatus failures, repairs
 - D. Water supply

- XI. SAFETY SECTOR
 - A. Discuss safety aspects of incident
 - B. Review injuries, causes, etc.
 - C. Review corrective actions
 - D. Haz Mat sector officer function

- XII. INVESTIGATIONS
 - A. Review cause, point of origin, fire spread
 - B. Update on investigation

PHOENIX REGIONAL
STANDARD OPERATING PROCEDURES

CRITIQUE SECTOR/INCIDENT ANALYSIS

M.P. 201.05G 03/02-R Page 14 of 14

CRITIQUE SUMMARY

ADDRESS OF INCIDENT
NUMBER OF ALARMS
DATE
INCIDENT NUMBER AND TIME

RESPONSE

Time - type of alarm - companies dispatched (list time, alarms, companies)

UNIQUE PROBLEMS

(List any unique problems)

ON-SCENE ACTIONS

Describe in brief summary of 2-3 paragraphs, the actions, tactics and plan of on-scene companies and Command.

LESSONS LEARNED

List lessons learned. Reference MP's where appropriate. Emphasize the positive. Present negatives in a positive manner.

INCIDENT ORGANIZATION CHART

Provide a Command organizational chart.

FIRE GROUND DRAWING

Attach an 8 x 11 drawing of the fire ground reflecting apparatus positioning, and hose line placement.

Example

An example of a completed critique summary will be included in critique packet supplied by the Tactical Services Section.

**PHOENIX REGIONAL
STANDARD OPERATING PROCEDURES**

Welfare Sector

M.P. 201.05H 06/18 Page 1 of 6

Activation of Welfare Sector

A Welfare Sector Officer will be established for any incident involving the serious injury or fatality of a member (or members) of the Phoenix Regional Department. This procedure will apply to both on-duty and off-duty incidents.

For on-duty incidents, the Incident Commander will be responsible for establishing the Sector. For off-duty incidents, the Appropriate Deputy Chief will establish the Sector and immediately notify the Assistant Chiefs of the Personnel Division, Operations, and the Fire Chief.

Chief Officers should be assigned Welfare Sector, Hospital Liaison, and Family Liaisons. It may be necessary for Dispatch and Deployment to “Special Call” a number of Chief Officers as needed.

Welfare Sector Duties

The Welfare Sector Officer will report to the Incident Commander and will be responsible for the following:

- Obtaining the latest information regarding injuries, circumstances, etc.
- Updating the Dispatch and Deployment
- Managing the notification of fire stations.
- Assigning a Hospital Liaison Officer(s).
- Assigning a Family Liaison Officer(s).
- Coordinate with the Public Information Officer.
- Notify and coordinate activities with Local 493.
- Notify the Fire Chief and Senior Staff.
- Provide/coordinate family transportation as needed.
- Coordinate Chaplain and other support needs.
- Securing the personal belongings of the injured member.

For major incidents, the Welfare Sector may be expanded to a Branch within the Incident Management System (i.e., multiple patients at multiple hospitals).

Reference the personnel section of Volume I for Welfare Sector functions stated in greater detail.

**PHOENIX REGINAL
STANDARD OPERATING PROCEDURES**

Welfare Sector

M.P. 201.05H 06/18 Page 2 of 6

Notification of Dispatch and Deployment Chief

Once a report is received that a firefighter has been seriously injured the Welfare Sector must communicate the following information to the Dispatch and Deployment Chief:

- Patient name(s)
- Receiving hospital(s)
- Nature and priority of injuries
- Hospital Liaison Officers (name, car #)
- Family Liaison Officers (name, car #)
- Other pertinent information

This information should be communicated in a confidential/secured manner. The Welfare Sector will identify persons that the Dispatch and Deployment Chief may release information to. The Dispatch Center staff will not release any names or identifying details to anyone not approved by the Welfare Sector.

Dispatch and Deployment Responsibilities

Dispatch and Deployment will be used to coordinate information and activity. The following additional Dispatch Center duties should be considered:

- Designate a Dispatch Liaison Officer (Alarm Room Chief)
- Coordinate information requests between family and the responding Family Liaison Officer and the Hospital Liaison Officer.
- Provide progress reports to the Welfare Sector.
- Do not release any names or identifying details to anyone not approved by the Welfare Sector.

Notification of Fire Stations

The Welfare Sector will initiate the notification of all fire stations of the incident involving injured Firefighters. Notification will not include names until the families are notified. This notification should include:

- A brief description of the incident.
- The number and priority of injuries.
- Receiving hospitals.

Updates should be given as more information is obtained. E-mail messages to station computer terminals should be used for this purpose, or the Dispatch Center can broadcast a message

**PHOENIX REGINAL
STANDARD OPERATING PROCEDURES**

Welfare Sector

M.P. 201.05H 06/18 Page 3 of 6

developed by the Welfare Sector. All updates must be approved by the Welfare Sector Officer before release.

Family Liaison Officers

The Welfare Sector officer must insure that a Family Liaison Officer is assigned to each family. It is essential that this officer make contact with the family as soon as possible. This notification should occur after all patients have arrived at hospitals. Family Liaison Officer duties include:

- Obtaining the latest information from the Welfare Sector Officer.
- Rapidly obtain the home or work address of the involved member.
- Rapidly respond to the family member (i.e., wife, husband).
- Provide appropriate, supportive notification.
- Provide/coordinate Chaplain or other support duties (i.e., CR Van).
- Provide/arrange transportation of family to the hospital or other locations.
- Provide progress reports to the Welfare Sector Officer.
- Coordinate information and activities with Hospital Liaison Officer.
- Coordinate any information needs of the family.
- Assist with any paperwork or other needs, support.
- Remain as the Family Liaison Officer until another Officer is assigned, or the incident is terminated, and the family agrees additional services are not needed.

Hospital Liaison Officer

The Welfare Sector will assign a Hospital Liaison Officer to each receiving hospital. The duties for this officer include:

- Rapid response to the assigned hospital.
- Coordinate activities and information with the hospital staff to ensure best patient care.
- Obtain the latest information regarding injuries, treatment, prognosis, etc.
- Communicate information to the Welfare Sector and the appropriate Family Liaison Officer.
- Provide on-going progress reports to the Welfare Sector Officer and Family Liaison Officer.
- The Hospital Liaison will remain in place until the Welfare Sector Officer and the family members determine it is no longer needed.

**PHOENIX REGINAL
STANDARD OPERATING PROCEDURES**

Welfare Sector

M.P. 201.05H 06/18 Page 4 of 6

Off-Duty/Out-of-Town Event

Should an incident occur while the member is off-duty or out of town/out of state, the Appropriate Deputy Chief will immediately be notified.

The Appropriate Deputy Chief will assume the initial Welfare Sector responsibilities or assign these responsibilities to another Chief Officer. Duties will include:

- Notify the Fire Chief and Senior Staff.
- Notify the Good and Welfare Officer.
- Assign a Family Liaison Officer.
- Assign a Hospital Liaison Officer (for Phoenix metro area hospitals).
- Implement the appropriate items listed in this procedure.

For events out of the Phoenix metro area, or out of state, it may be necessary to contact the Local Fire Department, as well as the Local Firefighters Union, to serve as the initial Hospital Liaison Officer and to provide other assistance.

Fire Department Member Responsibilities

Fire department members and co-workers will be highly concerned in these incidents. Members must understand that the Welfare Sector is designed to provide rapid, and accurate, support to the family. It is important that members not “freelance” and take self-initiated action. This kind of action in the past has often resulted in inaccurate information delivered to the family member, or the family transported to the wrong hospital. This only increases the emotional stress for the family.

Those members desiring to help should contact the Welfare Sector Officer. The system is designed to absorb the assistance to, as well as, provide the maximum support to family members.

Transfer of Welfare Sector Duties

During escalating serious incidents, the Welfare Sector responsibilities may be transferred to the Assistant Chief of Personnel Division, or a designee. At some point, the “crisis” management part of the Welfare Sector will stabilize. At this stage, duties may be transferred to the Welfare Officer at the Health Clinic for ongoing monitoring and support.

PHOENIX REGINAL
STANDARD OPERATING PROCEDURES

Welfare Sector
M.P. 201.05H 06/18 Page 5 of 6

Single Patient

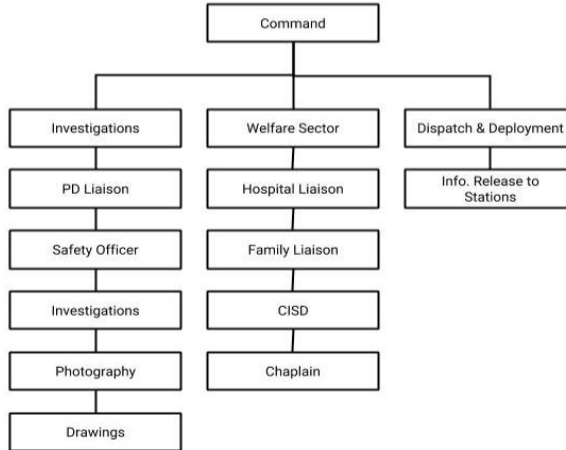

Welfare Branch-Multiple Patients, Multiple Hospitals

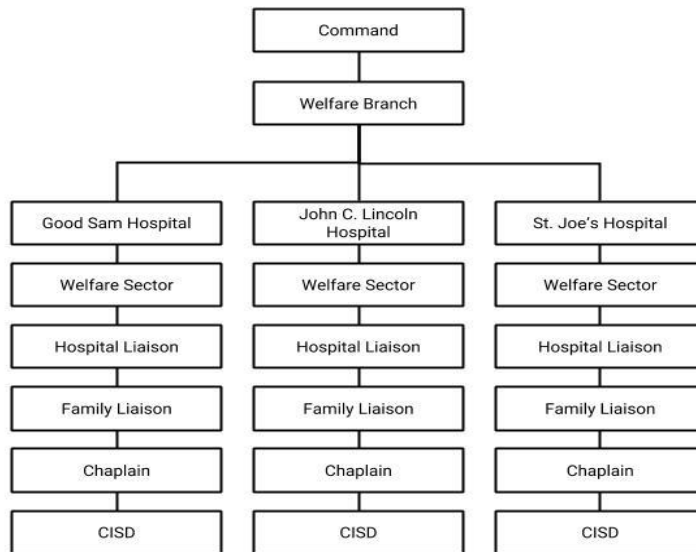

PHOENIX REGINAL
STANDARD OPERATING PROCEDURES

Welfare Sector
M.P. 201.05H 06/18 Page 6 of 6

Command Team

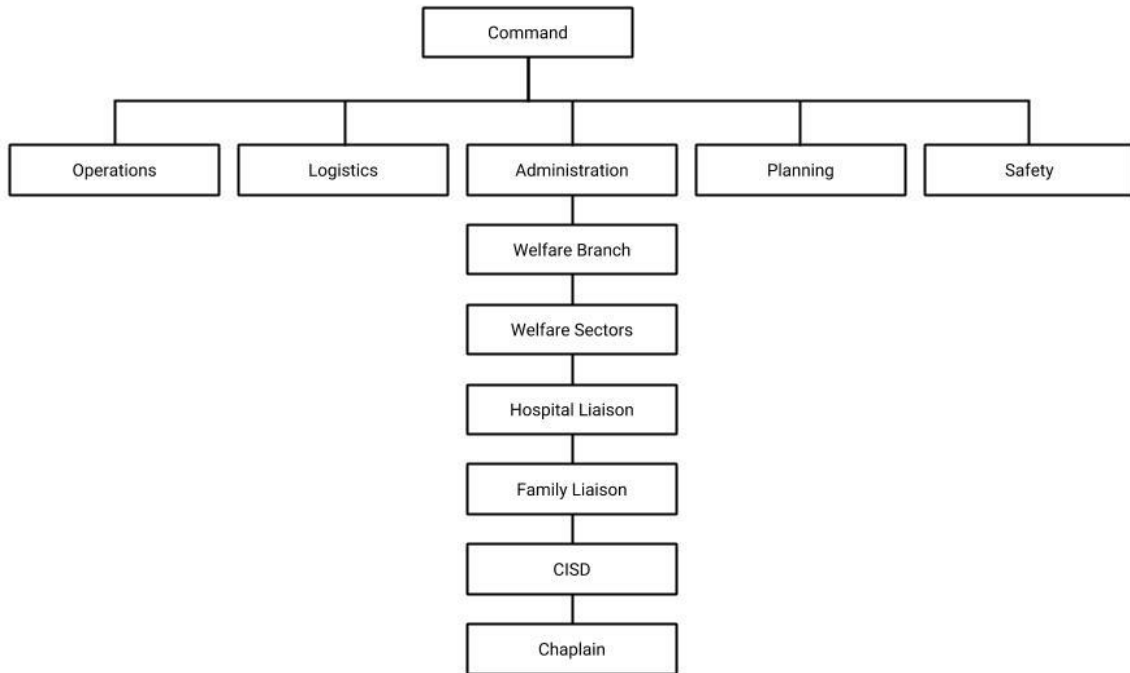

**PHOENIX REGIONAL
STANDARD OPERATING PROCEDURES**

FIRE THREAT LIAISON OFFICER (TLO)
M.P. 201.05I 02/21 Page 1 of 2

PURPOSE

The purpose of this procedure is to define the roles and responsibilities of the Threat Liaison Officer (TLO) in the Phoenix Regional Response System.

OVERVIEW

A large proportion of fire company responses involve some interaction of a routine nature between Law Enforcement and Fire personnel. These incidents are regularly and routinely handled in a very successful manner between the Company Officer and the Police Officers or Supervisors that respond. When incidents occur that require coordination and communication between law enforcement tactical units and fire companies, a request for the TLO of the jurisdiction having authority (JHA) shall be made to ensure all involved agencies work effectively. This coordination and communication is critical to ensure the safety of the community and the public safety personnel.

The request for the TLO is made using an incident assigned tactical channel or by contacting the appropriate regional dispatch center.

- For those agencies dispatched by the Phoenix Regional Dispatch Center, contact the Alarm Room Supervisor via phone at (602) 262-7496.
- For those agencies dispatched by the Mesa Regional Dispatch Center, contact the Alarm Room Supervisor via phone at (480) 644-2609.

The regional dispatch center will then contact the appropriate TLO for the jurisdiction, or representative assigned, share pertinent information, and determine the requirement for a response. The on-duty TLO will then contact the agency requesting assistance for additional information, intelligence, and determination of what type of response will be required. In most cases, this will include the initiation of a TLO nature code. For example, in the Phoenix Regional Dispatch System, the on-duty TLO will initiate a TLO-Operation (TLOOPS CAD nature code) and request the appropriate resources for the incident.

The TLO will assist in activities requiring coordination between the respective fire and law enforcement agencies. This includes but is not limited to:

- Law enforcement tactical operations, for example:
 - Special Assignment Units (SAU) or Special Weapons & Tactics (SWAT)
 - Fugitive Apprehension Investigations Detail (FAID)
 - Street Crimes
 - Explosive Ordnance Disposal (EOD)
 - Phase 1 Barricades

**PHOENIX REGIONAL
STANDARD OPERATING PROCEDURES**

FIRE THREAT LIAISON OFFICER (TLO)

M.P. 201.05I

02/21

Page 2 of 2

- Any nature code included in the following list:
 - 962PD, A3, ARFMR, BARHOS, CRASH, DL, GSW2, GSW2PD, GSW2S, GSW3, GSW3PD, GSW3S, GSWACT, GSWPD, GSWPDS, GSWSPD, INJPD, JUMP, NBC, STAB2, STAB2S, STAB3, VIACT
- Any request made by fire department or law enforcement personnel that require additional coordination or an extended operation related to a law enforcement incident.

The assigned TLO will be responsible for determining each situation's specific needs and communicating them to the law enforcement supervisor. The fire and law enforcement TLOs should remain at the Command Post to facilitate continuing communications.

INCIDENT RESPONSE

Incidents that meet the mission of law enforcement are led by the law enforcement agency having authority. These incidents may require Fire, EMS, or Special Operations functions to work in conjunction or coordination with law enforcement to mitigate or react to a potential hazard. In these situations, the Fire TLO should report to the Police Command Post to coordinate requests for assistance from the Police Department.

At times, the on duty TLO will be asked to support law enforcement activities in other municipalities. The on duty TLO will make the appropriate notifications to the TLO in the responding jurisdiction in which municipality the law enforcement operation will take place in. Any TLO responding to a law enforcement request that requires action in any other city or jurisdiction shall communicate this response to the on-duty TLO for that jurisdiction (or appropriate agency). At no time should a Fire TLO from any jurisdiction open a TLO-Operation incident and request resources without first notifying the TLO in the municipality of the operation.

A TLO-Operation shall require a TLO to serve as a liaison for fire response, coordinating efforts with their law enforcement counterpart, intelligence officer, and Incident Commander. TLO-Operations cannot be managed by any fire-based tactical EMS resource at any incident, regardless of whether they are a trained TLO or not. These fire-based tactical EMS resources include trained SWAT Medics, or TEMS personnel (or units).

Anytime a fire-based tactical EMS resource requests assistance, the Alarm Room Supervisor should notify the on duty TLO for that jurisdiction. An on scene TLO, working outside of the hazard zone, and dedicated to this function, must act as the liaison for fire companies at any law enforcement incident. This is to ensure effective communication, coordination, and operational focus between fire companies and law enforcement personnel.

**PHOENIX REGIONAL
STANDARD OPERATING PROCEDURES**

3 DEEP DEPLOYMENT MODEL & ADDITIONAL RESOURCES

M.P. 201.06

05/21

Page 1 of 3

POLICY

The decisions required to provide for adequate resources are an important factor in effective emergency incident management. The Incident Commander (IC) must balance the tactical problems with the resources required to control those problems and stay ahead of the situation through effective forecasting. Beware of "Crisis Management." Crisis management is often a situation that grows at a rate faster than the response rate to that situation. Often times the IC ends up with an out of control situation and inadequate resources to control it. Many times, the IC will reach a point where they begin to debate whether to call another alarm or not, in such cases call for it. If the extra resources are not needed, they can easily be put back in service.

3 DEEP DEPLOYMENT MODEL

Command must provide for a tactical reserve of fire companies. Command must deploy resources in support of their incident action plan. Command must have enough resources to provide for a tactical reserve of fire companies deployed in appropriate forward positions. This is to manage the strategic and tactical needs of the incident or sector and provide a reserve of resources to address a firefighter rescue should one arise. Command should expand the incident organization through sectorization and should utilize a 3-deep deployment model for resources within those sectors. The 3-deep deployment model for managing resources is as follows:

- Working
- On-Deck
- Recycle/Staged

ADDITIONAL RESOURCES

In most cases, Command should utilize the greater alarm mechanism, it is the quickest, provides for automatic move-ups and provides the support necessary for the additional resources/expanding incident. Command should resist the temptation to request assistance in a piecemeal fashion. Additional alarms should be struck sequentially which includes going from a 3 & 1 assignment, to a 1st alarm, to a 2nd alarm, etc. It is the continuing responsibility and function of Command to determine the resources required to control the situation and to provide for the timely call for any additional resources required.

The early call for additional resources will tend to consistently save the day. Command must be aware of both the capability and response time of additional resources and effectively integrate these factors in their decision to call more resources. Some tactical

**PHOENIX REGIONAL
STANDARD OPERATING PROCEDURES**

3 DEEP DEPLOYMENT MODEL & ADDITIONAL RESOURCES

M.P. 201.06

05/21

Page 2 of 3

situations move slowly, while some move very quickly. Command must call for additional resources at a rate that stays ahead of the incident. Some situations require the categorical call for additional alarms or upgrading an assignment upon knowledge of particular characteristics or conditions. In other situations, Command will initiate some fire control activities, ask for reports and, based upon receipt of bad news, will strike more alarms.

When calling for additional resources, Command must expand the incident organization to manage those additional resources. Command cannot encounter a big fire situation, call additional alarms and then expect to effectively manage those additional resources without expanding the incident organization through sectorization.

The following provides some examples of situations that will necessitate additional resources:

- An actual or potential fire situation exists, and the life hazard exceeds the rescue EMS capabilities of initial alarm companies.
- The number, location and condition of actual victims exceeds the rescue/removal/treatment capabilities of companies.
- An actual or potential fire situation exists, and the property protection demand exceeds the fire control capabilities of initial alarm companies.
- Fire conditions become more severe or the situation deteriorates significantly.
- All companies have been committed and the fire is not controlled.
- Command forecasts that forces could be depleted due to exhaustion; command must forecast the effect the fire will have on personnel and provide for the support of such personnel in advance.
- Command anticipates running out of some resource (firefighters, apparatus, water, equipment, command officers, etc.).
- There is evidence of significant fire, but companies are unable to determine location and extent.
- The commitment of companies is not effective.
- Companies cannot effectively perform early loss control operations.
- Situation becomes so widespread/complex that Command can no longer effectively manage; the situation requires a larger command organization and more sector functions.
- The weather is or has the potential to have a particularly exhausting effect on resources.

**PHOENIX REGIONAL
STANDARD OPERATING PROCEDURES**

3 DEEP DEPLOYMENT MODEL & ADDITIONAL RESOURCES

M.P. 201.06

05/21

Page 3 of 3

- Command instinctively feels the need to summon additional resources (don't disregard fireground hunches).

**PHOENIX REGIONAL
STANDARD OPERATING PROCEDURES**

AIR OPERATIONS

M.P. 201.07

09/01-R

Page 1 of 9

SCOPE

Several public and private helicopter services are available for various purposes, including emergency medical transportation, rescue from inaccessible locations, aerial reconnaissance of emergency scenes, brush firefighting, and emergency transportation of personnel and/or equipment.

The agencies involved in these services and available for emergencies are:

- Air Evac
- Life Net
- Mesa Police Department
- Native Air
- Department of Public Safety
- Phoenix Police Department
- Sheriff's Department
- Arizona Army National Guard
- Television Stations Channels 3, 5, 10, 12, 15
- Air Services International

PROCEDURES

Each agency's operating procedures, along with equipment and training limitations, present different operational capabilities. Command should request the type of helicopter and pilot support needed for a particular situation. Information on each agency is maintained in the CAD system.

Fire personnel should not fly with pilots or in aircraft that have not been approved and appropriately carded. If Command has a concern about the ability of the pilot or the overall safety of the operation, Command should stop the operation immediately.

EMERGENCY MEDICAL TRANSPORTATION

Helicopter transportation is available for patients within city areas, when time and distance affect ground transportation time. When sufficient ambulances are unavailable, or when patients are in locations inaccessible to ground units, helicopter transportation should be considered.

Med-Evac helicopters are capable of carrying; only one Immediate patient. Additional helicopters should be requested for incidents involving multiple Immediate patients. These aircraft are not approved for Technical Rescue air operations.

DPS helicopters are capable of carrying one patient only. DPS helicopter pilots must be advised of a litter patient prior to taking off or landing so that the interior of the helicopter can be put in proper configuration to accommodate the patient.

Helicopter medical transportation should be considered for -- Immediate trauma patients requiring urgent surgery, patients requiring specialized treatment (OB, pediatric, burns, neurological.) or any other patient Medical Control deems necessary.

**PHOENIX REGIONAL
STANDARD OPERATING PROCEDURES**

AIR OPERATIONS

M.P. 201.07

09/01-R

Page 2 of 9

AERIAL RECONNAISSANCE

Aerial observation may be desirable to assist Command in complex situations. This has proven extremely effective in brush firefighting, complex structural fires involving difficult access, high-rise fires, and for tracking direction and distance of air contamination at haz mat fires. Helicopters may be requested to place a fire department observer overhead with communications to Command.

Helicopters belonging to television stations and other media aircraft have been requested to avoid interference with ground operations. The same rules apply to landing in the incident area as apply to any other helicopters.

News station helicopters may be requested to provide assistance at incidents. Most news station helicopters have the capability to communicate on fire channels.

During major incidents, Command may request to have the surrounding airspace restricted to avoid interference with emergency operations. The request must be made to the FAA Flight Service Station. (Contact information is maintained in CAD file). News helicopters may or may not be restricted from this space at the discretion of command. News helicopters are not approved for use in technical rescue (SPECIAL USE) operations except as aerial observers.

TRANSPORTATION OF PERSONNEL AND/OR EQUIPMENT

Helicopters may be requested for transportation of personnel and/or equipment urgently needed at the scene of an emergency, particularly when distance is a factor. The request for assistance should include the number of personnel and the weight and volume of equipment to be transported.

Helicopters may also be used to transport personnel and equipment to the top of a high-rise building or across difficult terrain for firefighting purposes. An appropriately sized landing zone should be identified in close proximity to the staging area, with enough space and separation to provide for safe operations.

BRUSH FIREFIGHTING

Two methods of brush firefighting are available using helicopters. The Phoenix Police Air Unit has the ability to put two Bambi Buckets in service and are available to respond to brush fires to provide aerial water drop capability.

The Mesa Police Department has the ability to put one Bambi Bucket in service.

The Phoenix Fire Department currently has four buoy wall tanks. Mesa Fire Department has one buoy wall. The buoy wall tanks will hold either 3,000 or 4,000 gallons of water.

The Bambi Buckets can hold from 67 to 96 gallons of water, depending on air temperature and humidity and may be filled from a canal, buoy wall tank, or any other body of water that is available.

All drop instructions and reporting effectiveness of drops will be relayed to pilot by Command or an individual designated by Command. All personnel will remain clear of the drop zone.

NOTE: Helicopters with full buckets are prohibited from flying over occupied structures or traffic. Roadways must be closed or structures evacuated if no other flight path can be used.

**PHOENIX REGIONAL
STANDARD OPERATING PROCEDURES**

AIR OPERATIONS

M.P. 201.07

09/01-R

Page 3 of 9

BUOY WALL SET UP

The engine company assigned to the landing zone sector will assist the water tender driver with set up and filling the buoy wall tank. The buoy wall must be set up in a large flat area clear of overhead obstruction. Place one or two salvage covers on the ground to protect the bottom of the tank. Buoy wall tanks fill from the bottom only. Start filling the tank slowly after approximately one foot of water is in the tank the flow rate can be increased. Foam concentrate can be added to the tank when it is about one foot from the top.

NOTE: Apparatus must be kept at least 150' to the side of the flight path of helicopters dipping the tank.

CONTRACT HELICOPTER SERVICES

This service is provided by contract with the Phoenix Fire Department and involves an hourly charge for service. These helicopters can drop approximately 120 gallons of water on each pass over the fire. The drop can be directed on one spot or along a running pass.

One or more helicopters may be requested for the operation. Average flying time per fuel load is 1-1/2 to two hours and a refueling vehicle can be dispatched to the scene.

An engine company shall be assigned to control the landing zone. A supply line shall be laid from a hydrant and two 1-1/2 inch lines shall be extended. Lines are to refill belly tanks, wet down area, and to provide fire protection.

Crews will approach the helicopter only after making eye contact with the pilot and the pilot has to refill and re-arm belly tank. All refilling is done from the right side of the aircraft.

Crews will approach and withdraw along the same path; to front of the aircraft within 45 degrees. When the crew is clear and off to the sides, the landing zone officer will signal the pilot for take-off.

All drop instructions and reporting effectiveness of drops will be relayed to pilot by Command or an individual designated by Command. All personnel will remain clear of the drop zone.

RESCUE

Helicopters are particularly suited for physical rescue of persons stranded in inaccessible locations. Depending on the location of the victim, a helicopter may be useful in removing the victim or placing rescue personnel in a position to reach the victim.

Technical Rescue Team personnel, along with proper helicopter agency, should be considered for access to particularly difficult locations. The risk of using helicopters and placing rescue personnel in dangerous situations must be weighed against the urgency of the rescue situation. These considerations may be critical during hours of darkness or poor flying weather.

SPECIAL USE

"Special Use" of helicopters are activities that require pilots and rescuers to use certified technical rescue skills to affect the rescue of a patient or patients that are in critical condition or life-threatening situations. These are high-risk operations that can pose a serious threat to the life safety of both patients and rescuers.

**PHOENIX REGIONAL
STANDARD OPERATING PROCEDURES**

AIR OPERATIONS

M.P. 201.07

09/01-R

Page 4 of 9

The following are considered “Special Use” helicopters operations:

1. External load (slingloads, longlines, water bucket, etc.)
2. Hover sites (low-level hovering)
3. Helicopter rappelling (insertions and extraction’s)
4. Flights conducted below 500 feet above ground level (AGL)
5. Helicopter operations around a fire perimeter
6. Single skid landings
7. Any takeoff or landing requiring special pilot technique due to terrain, obstacles, or surface condition.

Any “Special Use” of helicopters during rescue operations will require a Technical Rescue Sector to be established by Command. It shall be the responsibility of the Technical Rescue Sector officer to establish and coordinate the rescue plan with the appropriate pilots and Fire Command.

“Special Use” helicopter operations shall only be performed by certified City of Phoenix Police Department pilots and Phoenix Fire Department Technical Rescue Technicians. Prior to initiating any rescue operation that required the “Special Use” of a helicopter, a risk benefit analysis will be completed by Technical Sector Officer (T.S.O), Phoenix PD pilot, and Command. The “Special Use” operation will only continue if this analysis determines the patient to be in critical condition, or a life-threatening situation exist for the patient(s) or rescuers.

HELICOPTER LOAD CALCULATION

Any “Special Use” of helicopters during rescue operations will require proper load calculations to be completed. Prior to initiating a rescue the pilot will perform a power check. After landing, the pilot will meet with the Technical Rescue Sector officer or a representative; together they will complete and sign the helicopter load calculation form. *The load calculation form will be required for both internal and external loads.*

The load calculation form will be retained by Technical Rescue Sector officer and submitted with the T.R.T. rescue report.

The pilot will insure that proper loading procedures are followed. All helicopters will be flown within the center-of-gravity envelope and gross weight limitations.

COMMUNICATIONS

Air-to-ground communications shall be used whenever possible to give landing instructions to approaching helicopters. Dispatch will coordinate the establishment of air-to-ground communications.

The pilot of a helicopter approaching the scene will advise Dispatch when ready to communicate with ground units. Dispatch will assign the radio channel to be used and advise Command of the identity of the helicopter. Direct air-to-ground communications shall then be established between the helicopter and Landing Zone personnel. Personnel in the landing area should have direct communications with the pilot before landing.

**PHOENIX REGIONAL
STANDARD OPERATING PROCEDURES**

AIR OPERATIONS

M.P. 201.07

09/01-R

Page 5 of 9

When helicopters are actively engaged in operations at the scene of an incident, Command should assign all helicopter communications to a separate radio channel and designate a person to work exclusively with this channel.

“Special Use” operations require a designated radio channel that is clear of any other traffic.

NOTE: National Guard helicopters have no direct communications capability with fire department ground units. Landing instructions must be given by hand signals.

Helicopters will not land in the incident area without first making contact with ground units. If unable to make contact on an assigned channel, the arriving helicopter shall circle or hover in the vicinity until contact is established.

Helicopters may be directed to land via hand or light signals when radio communication proves unfeasible. Landings shall not be made in proximity to the incident without positive contact (radios or hand signals).

FIREBIRD

Firebird is the designation for a helicopter operating under the direction of the Phoenix Fire Department. This includes Phoenix Police helicopters providing aerial reconnaissance, brush firefighting operations, transportation, or special use operations.

The designations "Firebird 1,2,3" etc., will be used to identify different helicopters in use on any one incident. Mesa Police Department helicopter designation is Falcon. Falcon 3 & 4 have the same capabilities as Firebird.

Ranger 41

Ranger 41 is the designation for the helicopter operating under the direction of the Department of Public Safety. This unit is staffed with 1 DPS officer/pilot, 1 DPS officer/paramedic, and 1 Phoenix Fire paramedic. R-41 has capabilities for emergency medical transportation and aerial reconnaissance transportation of manpower and equipment.

LANDING ZONES

The selection of an appropriate landing zone is of critical importance in all field situations. A suitable landing area must be located and identified for the pilot. **Should anything become unsafe during the approach of any helicopter during landing operations instruct the pilot to GO AROUND three times.**

Command will assign personnel to select and identify a landing zone. The assigned personnel shall have a portable radio, eye protection, ear protection, high-visibility safety vests. All personnel assigned to the landing zone operation shall be on the designated landing zone radio frequency. Engine companies are more suitable for this assignment.

**PHOENIX REGIONAL
STANDARD OPERATING PROCEDURES**

AIR OPERATIONS

M.P. 201.07

09/01-R

Page 6 of 9

The landing zone must be relatively flat and free of obstructions for an area of at least 100' x 100' for each helicopter. All spectators, vehicle traffic (including emergency vehicles) and animals must be kept a minimum of 200' away from the landing zone. In the center of the landing zone, a 60' x 60' "touch down" area shall be identified with appropriate visual markers. The individual communicating with the pilot shall stand at the front right corner (as seen by the pilot) of the touch down area. A visual check should be made for overhead wires, poles, towers, and similar obstructions. Any obstructions noted must be communicated to the pilot before he/she is committed. The pilot can then assess the obstruction.

"Special Use" landing zones are defined as any landing zone where the pilot cannot land and shut down power to the aircraft. "Special Use" landing zones are technical by nature and shall be staffed by members of the Technical Rescue Team at both the base and off-site landing zones.

The approach and departure paths (into the wind) must be free of obstructions. For heavily loaded helicopters (i.e., water drop), the clear path should extend at least 100 yards in each direction.

Approach and departure paths should not pass over a treatment area, Command Post, or other activity areas where noise and rotor wash will cause problems.

The landing zone should be located at least 100 yards from other activity areas.

The landing zone and surrounding area must be free of small objects which can be blown around by rotor wash. Check for metal objects and secure loose clothing or blankets.

Avoid dusty locations if possible. If the landing area is dusty, wet down the area with a hose line before landing.

Once a helicopter has landed the pilot may elect to shut down for added safety in the landing zone. While the helicopter is on the ground, whether running or not, a "tail guard" shall be stationed 50 to 100 feet from the tail rotor to keep the area secured. **At no time shall personnel pass behind the body of the helicopter and the tail rotor.**

Radio contact and the landing zone shall be maintained for two to three minutes after departure of the helicopter in case an in-flight emergency is experienced and the helicopter needs to return to the landing zone.

HELICOPTER SAFETY FACTORS

- Approach and depart helicopter from the front or 45 degrees from the front, in a crouching position; remain in view of the pilot.
- Establish eye contact with pilot or observer before approaching if rotors are moving.
- Do not approach helicopter after landing until pilot or observer signals approval to approach aircraft.
- Approach and depart in pilot's or observer's field of vision (never towards the tail rotor).
- At no time will personnel approach the tail area of any helicopter.
- Landing zone personnel shall use eye protection or helmet face shields and ear protection. Helmet chinstraps shall be tightened securely.
- Use a chinstrap or secure hardhat when working around main rotor.

**PHOENIX REGIONAL
STANDARD OPERATING PROCEDURES**

AIR OPERATIONS

M.P. 201.07

09/01-R

Page 7 of 9

- Keep landing areas clear of loose articles that may "fly" in the rotor down wash.
- Provide wind indicators for take-off and landings; back to the wind, arms extended in front of body.
- Beware of rotor wash. Small objects and clothing (caps, jackets, etc.) can be blown around easily. Do not grab or chase articles blown off by the rotor wash.
- Be aware the spotlights used to illuminate obstructions can blind the pilot. Extreme caution should be used. Only use spotlights to illuminate the bottom of poles. Do not shine upward.
- Fasten seat belt upon entering helicopter and leave buckled until pilot signals to exit. Fasten seat belt behind you before leaving.
- Use the door latches as instructed; caution should be exercised around moving parts or Plexiglas.
- Do not throw items from the helicopter.
- Carry tools horizontally and below waist level, never upright or over shoulder.
- Secure items internally and externally on the helicopter.
- Provide pilot with accurate weights and types of baggage.
- Stage patients waiting to be loaded at least 150 feet away. Secure sheets and blankets and cover eyes during landing.

PERSONAL PROTECTIVE EQUIPMENT (PPE)

PPE consists of clothing and equipment that provide protection to an individual in a hazardous environment.

All fire personnel and crew members will wear the following PPE when operating in or on the helicopter.

Flight Helmet: Must provide protection for the head.

Exceptions: TRT helmets or helicopter headsets may be used when a flight helmet is not necessary. (Flight helmets must be worn during long-line operations.) Fire helmets may be used by brush firefighters being transported to and from sites and firefighters in full protective clothing.

Fire Resistant Clothing: Nomex jumpsuit with length sufficient to eliminate exposure between boots and gloves, or structural firefighting coat and pants.

Exception: Brush firefighters may wear FR pants and Nomex brush jacket.

Leather Boots: Should extend above ankle.

Exception: Working in an environment not conducive to wearing leather boots.

Gloves: Should be leather or Nomex and leather.

SURFACE SELECTION

1. Concrete
2. Asphalt
3. Grass
4. Compacted dirt (lightly moistened to control dust)
5. Dry, loose dirt/sand (heavily moistened to control dust)

PHOENIX REGIONAL
STANDARD OPERATING PROCEDURES

AIR OPERATIONS

M.P. 201.07

09/01-R

Page 8 of 9

1

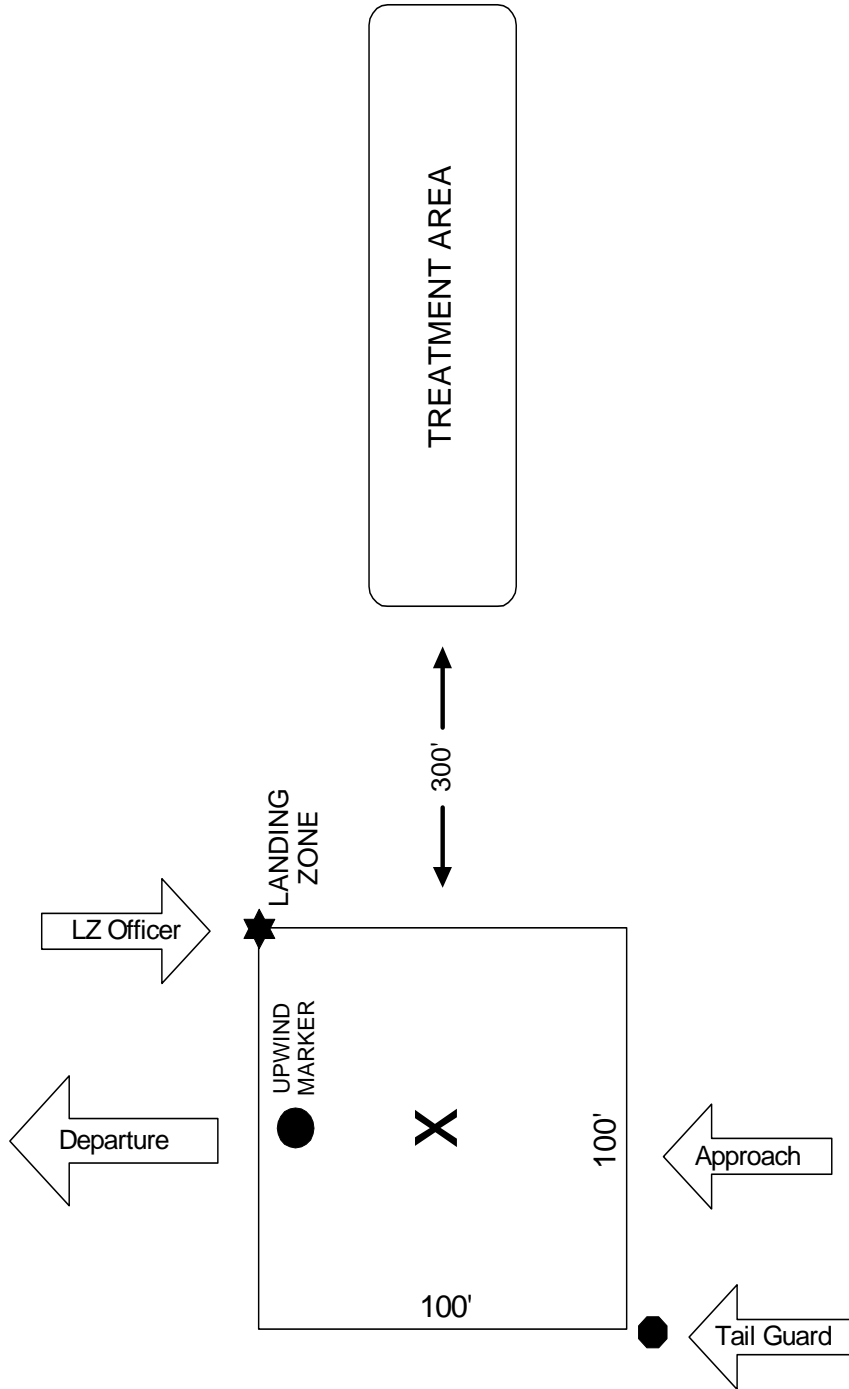

2

PHOENIX REGIONAL
STANDARD OPERATING PROCEDURES

AIR OPERATIONS

M.P. 201.07

09/01-R

Page 9 of 9

HELICOPTER HAND SIGNALS



CLEAR TO START ENGINE



TAKEOFF
Right hand behind back
Left hand pointing up



HOLD-HOVER
Place arms over head with clenched fists



MOVE UPWARD
Arms extended sweeping up



MOVE DOWNWARD
Arms extended, palms down, arms sweeping down



MOVE RIGHT
Left arm horizontal
Right arm sweeps upward to position over head



MOVE LEFT
Right arm horizontal
Left arm sweeps upward to position over head



MOVE FORWARD
Combination of arm and one hand movement in a circling motion pulling toward body



MOVE REARWARD
Hands above arm, palms out using a shoving motion



RELEASE SLING LOAD
Left arm down away from body. Right arm across left arm in a slashing movement from above



LAND
Arms crossed in front of body and pointing downward with backs to wind



SHUT OFF ENGINE
Slash across throat

**PHOENIX REGIONAL
STANDARD OPERATING PROCEDURES**

POST INCIDENT REVIEW

M.P. 201.08

08/96-R

Page 1 of 3

This procedure provides guidelines for conducting post incident reviews. Fire companies are usually involved with several incidents each shift after which they could participate in a post incident review. Participants will benefit most when a post incident review is conducted at the incident scene. Information will be fresh in everyone's mind and the scene may help to reinforce learning. The Battalion Chief or Company Officer can conduct a review after any incident.

Several areas will be identified for discussion in each review.

- Response times
- RIC response
- Safety
- Firefighting
- Rescue
- Property Conservation
- Loss Control
- Other customer service issues

A new form has been developed to assist the BC in being thorough and consistent in the review. The form should be completed by the Battalion Chief and forwarded to the Tactical Services Section for review, reporting, and training. The reverse side of the Tactical Worksheet and other review check sheets are good tools to use in assisting a review of any incident. Use visual references of the scene whenever possible.

The purpose of the **safety** component of this review is to emphasize firefighter safety by reinforcing safety behaviors, assess the current level of safety (measure how we're doing), and identify areas where safety improvement can be made.

The focus of the review should be on the overall operation, firefighter safety and survival, and customer service. Reinforce all safety behaviors. In doing so, remember that individual successes should not outweigh the safety of the overall operation or crews.

The Post Incident Review should be concluded on a positive note. Single company reviews which are conducted by Captains after an incident or training exercise can be used to chart a company's improvement. In areas such as safety, the review may assist in focusing on areas a company may need to improve. Included in this procedure are check sheets to be used as tools in evaluating operational safety.

**PHOENIX REGIONAL
STANDARD OPERATING PROCEDURES**

POST INCIDENT REVIEW

M.P. 201.08 08/96-R Page 2 of 3

CITY OF PHOENIX, ARIZONA
FIRE DEPARTMENT

FIRE CONTROL EVALUATION

EVALUATION # _____ SHIFT _____

INVESTIGATOR _____

BY _____

OFFENSIVE--DEFENSIVE--MARGINAL O/D

DATE _____ BATTALION _____

(Circle One)

WORKING FIRE--SMOKE CONDITION--OTHER

(Circle appropriate one(s))

Describe building/occupancy conditions on arrival and action taken _____

Describe effectiveness of operation _____

Describe special considerations (hazardous materials, rescue, welfare efforts, injuries) _____

Describe salvage/overhaul operations _____

Describe condition of scene for investigator/occupant _____

ITEMS REQUIRING ATTENTION

Procedures _____

Dispatch/Response _____

Apparatus _____

Training _____

Equipment _____

General Operations _____

Evaluations _____

Command _____

Protective Clothing _____

What operations would you Change? _____

What operations worked well? Why? _____

**PHOENIX REGIONAL
STANDARD OPERATING PROCEDURES**

POST INCIDENT REVIEW

M.P. 201.08 08/96-R Page 3 of 3

City of Phoenix, Arizona
Fire Department
E.M.S. INCIDENT EVALUATION FORM

Officer reporting _____ Battalion/Shift _____ Date _____

Card/Time _____ @ _____ Address _____

Treatment Level: E.M.T. Paramedic Other Units Responding _____

Description of incident (include number and priority of victims) _____

Describe extrication procedures performed _____

Describe treatment _____

Describe transportation _____

Describe how triage was performed _____

Describe anything that differed from Operational Manual; anything that created problems or caused the incident to work extremely well.

**PHOENIX REGIONAL
STANDARD OPERATING PROCEDURES**

Standard Company Functions

M.P. 202.01

01/18

Page 1 of 4

Standard Company Functions:

- Organize basic fireground functions and activities to companies based upon the capability and characteristics of each type of unit.
- Assign major fireground functions to the particular company who can best accomplish the operation.
- Integrate the efforts of Engine, Ladder, and Rescue companies to achieve effective rescue, fire control, and loss control activities.
- Increase the awareness and confidence of company members in the standard performance of other companies operating on the fireground.
- Reduce the amount and detail of orders required to get companies into action on the fireground.

Policy

The following items represent the standard functions that will normally be performed by Engine, Ladder, Heavy Rescue and Rescue companies. These basic functions will provide the framework for field operations for these companies. Incident Commanders shall assign Engine, Ladder, Heavy Rescue and Rescue companies with their appropriate function whenever possible.

Engine Company Functions:

- Incident Size up
- Assumption of Command
- Coordinate 360° incident assessment
- Search, rescue, and treatment
- Forcible Entry
- Stretch hose lines
- Operate nozzles
- Pump hose lines
- Loss control

**PHOENIX REGIONAL
STANDARD OPERATING PROCEDURES**

Standard Company Functions

M.P. 202.01

01/18

Page 2 of 4

Ladder Company/Tender Functions:

- Incident Size up
- Assumption of Command
- Coordinate 360° incident assessment
- Search, rescue, and treatment
- Coordinated horizontal and vertical ventilation
- Forcible entry
- Raise ground ladders
- Provide access/check fire extension
- Utility control
- Provide lighting
- Operate ladder pipes (aerials and platforms only)
- Perform overhaul
- Extrication
- Loss control

Rescue Company Functions:

- Transportation of sick and injured to hospitals
- Search, rescue, and treatment--Rescue companies should communicate commitment and location to Command and maintain a retrievable status for victim treatment and transportation
- General firefighting duties as assigned by Command

**PHOENIX REGIONAL
STANDARD OPERATING PROCEDURES**

Standard Company Functions

M.P. 202.01

01/18

Page 3 of 4

Heavy Rescue Company Functions:

- Incident size-up
- Assumption of Command
- Coordinate 360° incident assessment
- Search, rescue, and treatment
- Stretch hose lines
- Operate nozzles
- Loss control
- Obtain 360°
- Coordinated horizontal and vertical ventilation
- Forcible entry
- Raise ground ladders
- Provide access/check fire extension
- Utility control
- Provide lighting
- Perform overhaul
- Extrication
- Loss control
- Structural collapse/shoring
- Heavy lifting

Operational Information

In Level 1 Staging situations, first arriving Engine, Ladder or Heavy Rescue, and Rescue companies will perform these functions as required and ordered by Command.

Company Officers will determine based upon conditions and the Risk Management Plan, the priority of the functions for their company unless otherwise ordered by Command. This does not limit a company to only its listed functions. Every company will be expected to perform all basic functions safely within the limits of their capability, and it will be the on-going responsibility of Command to integrate tasks and functions as required with the on-scene units.

**PHOENIX REGIONAL
STANDARD OPERATING PROCEDURES**

Standard Company Functions

M.P. 202.01

01/18

Page 4 of 4

In the absence (or delay) of Ladder company response, Command should assign ladder functions to a Heavy Rescue or an Engine company. For example, Command may assign an Engine company to perform salvage or overhaul. The assignment of these basic operations represents a standard fireground plan for task and tactical operations designed to improve the effectiveness and safety of all units working together. This plan should in no way limit the initiative of any officer and should enhance the decision-making process of all officers by establishing a standard operational framework.

**PHOENIX REGIONAL
STANDARD OPERATING PROCEDURES**

Fireground Factors

M.P. 202.02

01/18

Page 1 of 6

Fireground factors offer a standard list that the Incident Commander must consider in the evaluation of an incident. Critical Fireground Factors are determined through deliberate and focused size-up with intent of evaluating the incident to determine how and to what extent the tactical objectives will be met for any particular incident.

Operational Information

The establishment of the Critical Fireground Factors for any incident is done through the standard process of size-up. Size-up is defined as: “an appraisal of the magnitude or dimensions of an event or incident”.

The Critical Fireground Factors are meant to be used as a tool to assist the Incident Commander with simplifying complex information into 7 distinct categories. They are meant to provide the Incident Commander the ability to categorize and simply communicate what is critical within a specific incident. Not all factors are typically critical for every incident. The ability of the incident commander to identify what size-up information is truly critical to the accomplishment of the tactical objectives is very important. It is equally important for the Incident Commander to set aside or disqualify factors that are not directly important to the incident outcome.

It is unacceptable to begin operations before adequately performing size-up and considering the critical fireground factors. A fire attack is many times an instinctive action-oriented process that involves taking the shortest and quickest route directly to the fire. Action feels good in fireground situations while it can be perceived that thinking delays action. Beware of non-thinking attack situations and non-thinking attackers, they are dangerous and unacceptable.

Fireground factors represent an array of items that are dynamic during the entire fireground process. The relative importance of each factor changes throughout that time frame. Command must continually deal with these changes and base decisions on fireground factor information that is timely and current. Beware of developing an incident action plan and sticking to that same plan throughout the fire, even though conditions continue to change. Effective fire operations require action plan revisions that continually reconsider fireground factors based upon information feedback.

In critical fire situations, Command may develop an incident action plan and initiate an attack based on incomplete information compiled in an initial size-up. This may leave the Incident

**PHOENIX REGIONAL
STANDARD OPERATING PROCEDURES**

Fireground Factors

M.P. 202.02

01/18

Page 2 of 6

Commander with significant questions regarding the incident structure, conditions and/or occupancy. This is defined as critical unknown information. In such cases, efforts must continue throughout the operation to improve the information on which those decisions are based. Command will seldom operate with complete information during initial operations.

The effective management of each fireground factor requires Command to apply all methods of information gathering and communication (i.e., visual, recon, preplan) to each factor. This is particularly true between the major categories of fireground factors. Command must deal with each factor in the most effective manner.

Most incident situations represent a complex problem regarding how Command deals with fireground factor information. There are factors that can be determined from a Command position on the outside of the structure and other factors that can only be determined from other operating positions, both outside and inside the structure. During an incident, fireground factor information is gathered utilizing one or more of the following overlapping forms of size up:

1. *Visual:* Fireground factors which are obvious to visual observation and those absorbed subconsciously. This visual information is categorized as the type that can normally be gained by actually looking at a tactical situation from the outside. This form of intelligence involves the perceptive capability of Command.
2. *Reconnaissance:* Fireground information that is not visually available to Command from a position on the outside of a tactical situation and must be gained by actually sending someone to check-out, go-see, look-up, research, advise, call, go-find, etc. This generally involves Command making a specific assignment for the coordination and completion of a 360° recon and then receiving an information-oriented report.
3. *Preplanning and Familiarity:* Intelligence that is gained from formal pre-fire planning, general informal familiarization activities and from C.A.D. through the M.D.T. (e.g., bldg. drawings, hazardous materials, etc.). Such intelligence increases the information initially available to Command from the OUTSIDE of a tactical situation. This information provides Command with intelligence that would otherwise have to come from a Reconnaissance report or might not be available.

The following are fireground factors which should be evaluated by Command as they pertain to each tactical situation. They can be obtained by using the above information management factors.

**PHOENIX REGIONAL
STANDARD OPERATING PROCEDURES**

Fireground Factors

M.P. 202.02

01/18

Page 3 of 6

BUILDING

- Size
- Roof type (bow string, bar joist, etc.), and condition
- Roof covering (concrete, composite, tile)
- Interior arrangement/access (stairs, halls, elevators)
- Construction type
- Age
- Condition (faults, weaknesses)
- Value
- Compartmentation/separation
- Vertical/horizontal openings (shafts, channels)
- Outside openings (doors and windows/degree of security)
- Utility characteristics (hazards/controls)
- Concealed spaces/attic characteristics
- Exterior access
- Effect the fire has had on the structure (at this point)
- Time projection on continuing fire effect on building

FIRE

- Size
- Extent (% of structure involved)
- Location
- Stage (inception, free-burning, flashover)
- Direction of travel (most dangerous)
- Time of involvement
- Type and amount of material involved (structure/interior finish/contents)
- Type and amount of material left to burn
- Product of combustion

**PHOENIX REGIONAL
STANDARD OPERATING PROCEDURES**

Fireground Factors

M.P. 202.02

01/18

Page 4 of 6

OCCUPANCY

- Specific occupancy
- Type/group (business, mercantile, public assembly, institutional, residential, hazardous, industrial, storage, school)
- Value characteristics associated with occupancy
- Fire load (size, nature)
- Status (open, closed, occupied, vacant, abandoned, under construction)
- Occupancy associated characteristics/hazards
- Type of contents (based on occupancy)
- Time (as it affects occupancy use)
- Loss Control profile/susceptibility of contents to damage/specific loss control needs (computers, business records, etc.)

LIFE HAZARD

- Number of occupants
- Location of occupants (in relation to the fire)
- Condition of occupants (by virtue of fire exposure)
- Incapacities of occupants
- Commitment required for search and rescue (personnel, equipment, and Command)
- Fire control required for search and rescue
- Needs for EMS
- Time estimate of fire effect on victims
- Exposure of spectators/control of spectators
- Hazards to fire personnel
- Access rescue forces have to victims
- Characteristics of escape routes/avenues of escape (type, safety, fire conditions, etc.)

**PHOENIX REGIONAL
STANDARD OPERATING PROCEDURES**

Fireground Factors

M.P. 202.02

01/18

Page 5 of 6

ARRANGEMENT

- Access, arrangement, and distance of external exposure
- Combustibility of exposures
- Access, arrangement, and nature of internal exposures
- Severity and urgency of exposures (fire effect)
- Value of exposures
- Most dangerous direction (avenue of spread)
- Time estimate of fire effect on exposures (internal and external)
- Obstructions to operations
- Capability/limitations on apparatus movement and use

RESOURCES

- Personnel and equipment on scene
- Personnel and equipment responding
- Personnel and equipment available in reserve or in Staging
- Estimate of response time for additional resources
- Condition of personnel
- Capability and willingness of personnel
- Capability of Command personnel
- Availability of hydrants
- Supplemental water sources
- Adequacy of water supply
- Built-in private fire protection (sprinkler, standpipe, alarms)
- Outside agency resource and response time

**PHOENIX REGIONAL
STANDARD OPERATING PROCEDURES**

Fireground Factors

M.P. 202.02

01/18

Page 6 of 6

OTHER FACTORS/CONDITIONS

- Time of day/night
- Day of week
- Season
- Special hazards by virtue of holidays and special events
- Weather (wind, rain, heat, cold, humid, visibility)
- Traffic conditions
- Social conditions (strike, riot, mob, rock festival)

**PHOENIX REGIONAL
STANDARD OPERATING PROCEDURES**

Tactical Objectives

M.P. 202.02A

01/18

Page 1 of 2

Tactical Objectives identify the three separate and critical events that must be completed to stabilize any incident.

These objectives though separate are interrelated activities which must be dealt with concurrently. Completion and priority of the objectives is directly correlated to the size up, risk management and conditions of the incident.

The tactical objectives are as follows:

1. Rescue
2. Fire Control
3. Property Conservation

Rescue - The activities required to protect occupants, remove those who are threatened and to treat the injured.

Fire Control - The activities required to stop the forward progress of the fire and to bring the fire under control.

Property Conservation - The activities required to stop or reduce primary or secondary damage to property.

When each tactical objective is reached the following benchmarks of completion are announced

<u>Tactical objective</u>	<u>Announce Benchmark</u>
Rescue/ primary search	- All clear
Fire Control	- Under control
Property Conservation	- Loss stopped

All three tactical objectives require somewhat different tactical approaches from a Command and an operational standpoint.

While Command must satisfy each tactical objective they often occur simultaneously. Notable examples are the frequent need to achieve interior tenability with active/extensive fire control efforts before proceeding with primary search, or the need to initiate property conservation activities while active fire control efforts are being extended.

PHOENIX REGIONAL
STANDARD OPERATING PROCEDURES

Tactical Objectives

M.P. 202.02A

01/18

Page 2 of 2

The tactical objectives, (Rescue, Fire Control, Property Conservation) are clear, measurable, and obtainable objectives. Completion and priority of the objectives is directly correlated to the size up, risk management and conditions of the incident.

Within the Command framework lies an on-going responsibility that is not completed with benchmarks. This is often referred to as the umbrella of service. The umbrella of service is made up of three on-going considerations. They are fire fighter safety, customer service, and loss control.

Customer Service

We recruit members that understand the importance of customer service. We acknowledge positive customer service actions and look for ways to better serve our customers.

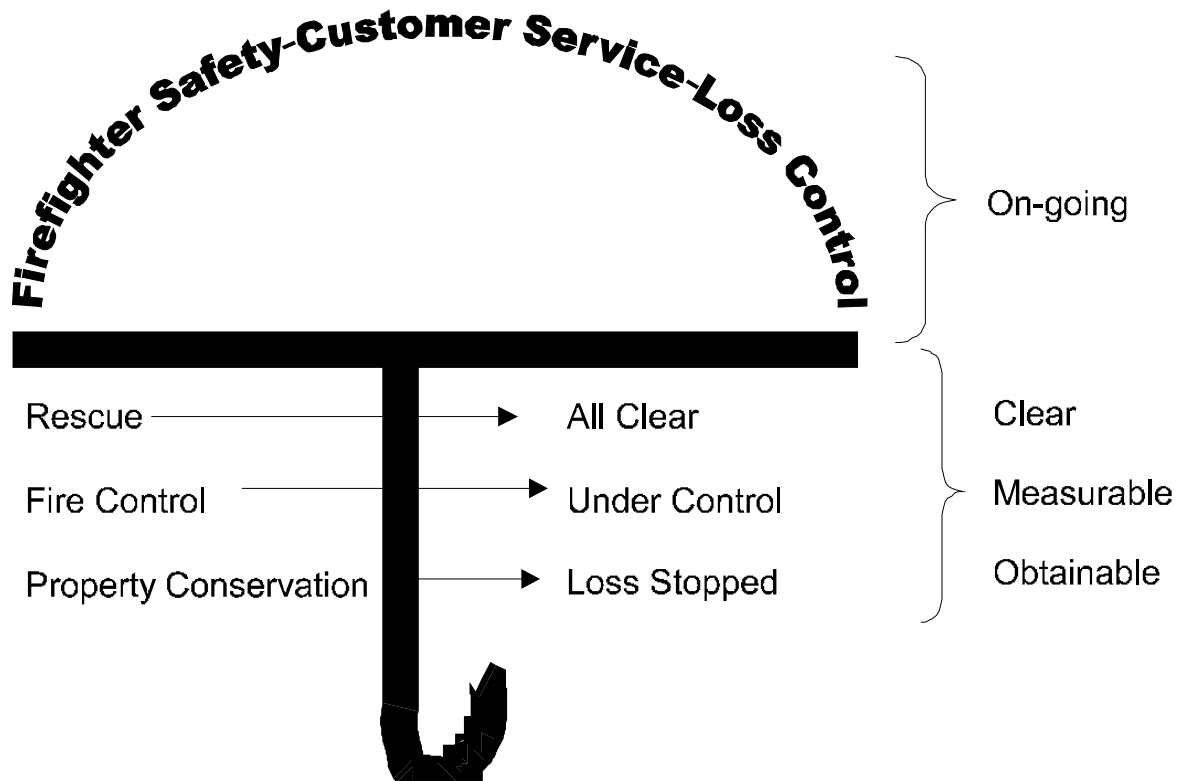

**PHOENIX REGIONAL
STANDARD OPERATING PROCEDURES**

Fireground Strategy

M.P. 202.02B

01/18

Page 1 of 7

Procedure

Structural fireground operations will fall in one of two strategies, Offensive or Defensive. Fireground strategy is determined and declared by the Incident Commander on all structure fire incidents. The Incident Command constantly reevaluates the fireground strategy, driven by size up and risk management.

The Offensive or Defensive strategies are based on the application of the Risk Management Plan.

1. We Will risk our lives a lot, in a calculated manner, to save SAVABLE lives.
2. We Will risk our lives a Little, in a calculated manner, to save SAVABLE property.
3. We Will Not risk our lives at all for lives or property that are already Lost.

Considering the level of risk, the Incident Commander will choose the proper strategy to be used at the fire scene.

The strategy can change with conditions or because certain benchmarks (i.e., ALL CLEAR) are obtained.

The fireground strategy is also based on a reevaluation of the incident size-up, all Fireground Factors and reconsideration of risk.

Fireground Factors:

- Building
- Fire & Smoke
- Life Hazard
- Occupancy
- Arrangement
- Resources
- Other

Operational Information

The Incident Commander is responsible for determining the appropriate fireground strategy. Once the appropriate strategy is initiated, it becomes the Incident Commander's job to ensure

PHOENIX REGIONAL
STANDARD OPERATING PROCEDURES

Fireground Strategy

M.P. 202.02B

01/18

Page 2 of 7

that all personnel are operating within the correct strategy. By controlling the fireground strategy, the Incident Commander is providing overall incident scene safety. The proper strategy will be maintained by the following actions:

- Avoiding simultaneous OFFENSIVE and DEFENSIVE strategies in the same fire area. This typically happens by first committing personnel to interior positions, then operating master streams from exterior positions, which places interior crews in danger of injury or death.
- Matching the appropriate strategy to the fire conditions of the structure and minimizing risk to fire fighters.

Managing fireground strategy must start with the arrival of the first unit and be constantly monitored and evaluated throughout the entire incident. The initial Incident Commander will include the fireground strategy in the on-scene report. As Command is transferred to later arriving officers, these officers assuming Command must reevaluate the fireground strategy based on the Risk Management Plan.

Fireground strategy provides a starting point for fireground operations. Once the strategy is announced, all firefighters know whether to operate on the interior or exterior of the building. The fireground strategy cannot be a mystery, everyone operating on the fireground must be operating in the same strategy mode (Offensive *or* Defensive).

Offensive Strategy



Commercial and residential fires require a thorough size up, assessment of life safety, and consideration of the Risk Management Plan. Once it is determined that an offensive attack is safe and appropriate, a smart and deliberate execution of the tactical objectives will be

**PHOENIX REGIONAL
STANDARD OPERATING PROCEDURES**

Fireground Strategy

M.P. 202.02B

01/18

Page 3 of 7

conducted. The following are guidelines for offensive fire attacks once size up has been completed and offensive strategy has been determined:

1. Assume Command
2. Address 2 in / 2 out decision prior to entry.



3. Initial attack efforts must be directed toward supporting a primary search. This may require rescuers to go to obvious victims or to manage the hazard and extinguish the fire. The first attack line must go where it can best affect this mission and its placement is dependent upon the variables present on the fireground, determine fire conditions and extent before starting fire operations (as far as possible). Gather 360° of information; identify the flow path and the most likely location of the fire and survivable environments for victims. Search, rescue and fire attack are simultaneous operations.
4. Offensive fires should be fought aggressively, with rapid and effective size up. Quickly identify conditions in the occupancy and apply the quickest, most appropriate, water to the fire.
5. Keep the building openings closed if possible to reduce ventilation of the fire until you have a charged hose line in place and are prepared to make entry.
6. *Before making entry* When possible reset or darken down the fire using a straight stream applied to the ceiling of the fire compartment. 15-30 seconds of water applied in this manner will dramatically reduce temperatures and improve tenability throughout the occupancy. This tactic must be followed by an aggressive interior attack to complete fire extinguishment and evacuate any victims.
7. Make every effort to enter the structure at the air intake side of the flow path. You want the air at your back as you make entry. This will reduce the likelihood of being caught in the flow path.
8. Co-ordinate all ventilation of the structure to ensure effectiveness and improvement of interior conditions.

**PHOENIX REGIONAL
STANDARD OPERATING PROCEDURES**

Fireground Strategy

M.P. 202.02B

01/18

Page 4 of 7

Companies must maintain situational awareness and resist the urge to focus only on the fire (this is known as the "candle moth" syndrome or "tunnel vision"). In some cases, the most effective tactical analysis involves an evaluation of what is not burning rather than what is actually on fire. The unburned portion represents where the fire is going and should establish the framework for fire control activities and requirements.

Command must consider the most critical direction and avenues of fire extension, plus its speed, particularly as they affect:

- Rescue activities
- Level of risk to firefighters
- Confinement efforts
- Exposure protection

Command must allocate personnel and resources based upon this fire extension/spread evaluation.

Command must not lose sight of the very simple and basic fireground reality that at some point firefighters must engage and fight the fire. Command must structure whatever operations are required to put water on the fire. The rescue/fire control-extension/exposure problem is solved in most cases by a fast, strong, well-placed attack. Command must establish an attack plan that overpowers the fire with actual water application, either from offensive or defensive positions.

Command must consider the seven sides (or sectors) of the fire: front, rear, both sides, top, bottom, and interior. Fires cannot be considered under control until all seven sides are addressed. Failure to address all seven sides will frequently result in fire extension.

Where the fire involves concealed spaces (attics, ceiling areas, construction voids, etc.), it becomes paramount that companies identify and operate fire streams into such areas. Early identification and response to concealed space fires will save the building. Officers who hesitate to gain access to concealed spaces because they don't want to beat up the building may lose the entire structure.

Early coordinated ventilation is a major support item that must be addressed during concealed space attacks. Ventilation must be initiated early and be well coordinated with interior crews. Ventilation openings should be made in the fire area.

PHOENIX REGIONAL
STANDARD OPERATING PROCEDURES

Fireground Strategy

M.P. 202.02B

01/18

Page 5 of 7

Command must "get ahead" of the fire. Command must make critical decisions that relate to cutoff points and develop a pessimistic fire control strategy. It takes a certain amount of time to get water to a location, and the fire continues to burn while the attack is being set up. Command must consider where the fire will be when attack efforts are ready to go into operation; if misjudged, the fire may burn past the attack/cutoff position before resources and personnel are in position. Do not play "catch up" with a fire that is burning through a building. Project your set-up time, write off property and get ahead of the fire. Set up adequately ahead of the fire, then overpower it.

Write-off property that is already lost and go on to protect exposed property based on the most dangerous direction of fire spread. Do not continue to operate in positions that are essentially lost.

The basic variables relating to attack operations involve:

- Location/position of attack
- Size of attack
- Support functions

Command develops an effective attack through the management of these factors. Command must balance and integrate attack size and position with fire conditions, risk and resources.

Many times, offensive/defensive conditions are clear cut and Command can quickly determine the appropriate strategy. In other cases, the conditions are Marginal, and Command must clearly communicate these conditions.

A Marginal situation is defined as defensive conditions with a known rescue

A Marginal situation has a very short window to affect a rescue or to discontinue the attempt and begin a defensive fire attack.

Strategy changes can develop almost instantly or can take considerable time. Command must match the strategy with the conditions. The Incident Commander controls overall incident scene safety by determining the proper strategy and subsequently the proper tactics to be used.

**PHOENIX REGIONAL
STANDARD OPERATING PROCEDURES**

Fireground Strategy

M.P. 202.02B

01/18

Page 6 of 7

If the Incident Commander doesn't change strategies from offensive to defensive until the building is disassembling itself due to structural damage, Command is late in strategy determination and on the receiving end of the building's decision governing the new strategy to be employed. Often times when the building gets to make those decisions, fire fighters become traumatized (physically and/or emotionally). The Incident Commander determines the strategy, the building should not.

Command needs to constantly evaluate conditions while operating in marginal situations. This requires frequent and detailed reports from Sector Officers.

It is imperative that Command assign a Roof Sector as early as possible during marginal situations for rapid evaluation of roof conditions. In certain situations, Command should strongly consider not committing crews to the interior of a structure unless he/she receives a report from Roof Sector that the roof of the structure is safe to operate on and under. It is better to go from an offensive to a defensive strategy too soon rather than too late.

Defensive Strategy

The decision to operate in a defensive strategy indicates that the offensive attack strategy, or the potential for one, has been abandoned. The elements of an effective defensive strategy always include:

- Identify what is lost
- Write it off
- Protect exposures

The announcement of a change to a defensive strategy will be made as Emergency Traffic and all personnel will withdraw from the structure and maintain a safe distance from the building. Captains will account for their crews and advise their Sector Officer on the status of their crew. Sector Officers will notify Command of the status of the crews assigned to their sector. A PAR (Personnel Accountability Report) shall be obtained after any switch from offensive to defensive strategy.

**PHOENIX REGIONAL
STANDARD OPERATING PROCEDURES**

Fireground Strategy

M.P. 202.02B

01/18

Page 7 of 7

Interior lines will be withdrawn and repositioned when changing to a defensive strategy. Crews should retreat with their hose lines if safe to do so. If retreat is being delayed because of hose lines, and it is unsafe to stay in the building, hose lines should be abandoned.

All exposures, both immediate and anticipated, must be identified and protected. The ability to protect these exposures from any appropriate position must be assessed and coordinated. This must match the overall strategic level incident size-up and position in the risk management plan.

An attempt to control the main body of fire is critical. This may be the best thing to assist in protection of exposures.

Master streams are generally the most effective tactic to be employed in defensive operations. For tactical purposes, a standard master stream flow of at least 750 GPM should be the guideline. Adjustments may be made upward or downward from this figure, but it is very significant in the initial deployment of master streams.

When the exposure is severe, and water is limited, the most effective tactic is to put water on the exposure. Once exposure protection is established, attention may be directed to knocking down the main body of fire and thermal column cooling. The same principles of large volume water application should be employed.

“FIRE UNDER CONTROL” means the forward progress of the fire has been stopped and the remaining fire can be extinguished with the on-scene resources; it does not mean the fire is completely out. When the fire is brought under control, Command will notify Alarm utilizing the standard radio report of "FIRE UNDER CONTROL" and alarm will record the time of this report. Command must initiate a PAR report from all sectors and crews.

If defensive operations are conducted from the onset of the incident, Command will notify Alarm that there will not be a primary search completed for the affected structure(s).

PHOENIX REGIONAL STANDARD OPERATING PROCEDURES	
Policy Name: RESCUE	Policy Number: M.P. 202.02C
This policy is for internal use only and does not expand an employee's legal duty or civil liability in any way. This policy should not be construed as creating a duty to act or a higher duty of care, with respect to third party civil claims against employees or the Phoenix Fire Department (PFD). Remedies for violations of this policy, if proven, are limited to administrative disciplinary action against PFD employees.	
Related Policies: 201.01, 201.01C, 201.06, 202.04, 202.05, 202.12E	
Other Reference: UL Fire Safety Research Institute	
Date Implemented: 03/2022-R	Review Date: 03/2026

Life safety is the highest tactical priority on the fireground and in all other hazard zones. The primary focus of hazard zone operations is to size up an incident to assess for the presence or likelihood of savable lives and build a plan to execute the rescue of victims. There are many potential actions that can best facilitate the successful rescue and/or removal of victims and are dependent on conditions and resources.

The two elements that are of greatest threat to fire victims are toxic and thermal exposure. Toxic exposure to the products of combustion is less about the proximity to the fire and directly impacted by the volume and movement of the smoke and gases in the interior of the structure. The degree of which victim(s) are exposed to toxic smoke is directly related to their elevation and location in the building. Since heat and smoke rises and travels throughout the building, victims in elevated locations are at a higher risk. Exceptions exist, like for instance a closed interior door that protects the victims from the smoke and heat.

Thermal exposure is directly related to the proximity to the fire and the elevation a victim is in the interior. Victims located near to or in the flow path inside the structure are at significantly more risk as well. The closer a victim is and the higher they are in the interior space, the greater the total exposure and danger. Barriers, such as closed doors and furniture, can provide some protection from thermal exposure to trapped victims inside of a structure.

We initiate every fire response with the expectation that we will encounter fire and smoke conditions that are endangering the occupants. An effective size up, utilizing all forms of information gathering available, is critical. Exterior fire and smoke conditions can give clues to the most endangered spaces but is not always reliable as to the extent and threat level to the victims. A size-up from the interior is necessary to assess the immediate conditions potentially impacting victims and may be very different from the exterior perspective. It is critical to assess the most

effective action on the fireground to improve the tenability of victims prior to rescue. Sometimes this action involves an effective fire attack from the most advantageous position (interior or exterior) to improve the conditions. Other times it may involve immediately working to remove victims utilizing the path of safest removal. Removing the victims from the fire or removing the fire/heat/smoke from the victims is a critical decision at all active fire incidents where savable lives exist.

PROCEDURE

The Incident Commander (IC) shall direct fireground efforts to protect savable lives. For example, on residential fires, the IC shall direct a primary search in all involved and exposed occupancies when aligned with the risk management profile. When appropriate at non-residential fires, the IC should take steps to facilitate and support evacuation of the fire occupancy as well as exposures.

The IC should determine the most effective action utilizing the limited initial resources to best impact victim rescue. The initial action may be an exterior or interior fire attack coupled with immediate rescue actions. The Incident Commander must structure initial operations around the completion of the primary search.

The Incident Commander must consider the following factors in developing a basic rescue size-up:

- Number, location, and condition of victims.
- Fire conditions and the impact it has on the victims.
- What actions best impact the survivability and/or tenability of the victims?
- What actions best impact our ability to search the structure?
- Can firefighters access the victims?
- How are they going to be removed from the structure?

Note: The IC should ensure a 360 is completed on all incidents to assess the factors above.

Command must make the basic rescue decision:

- Do we remove the victims from the fire? OR
- Do we remove the fire from the victims?
- Do the conditions and resources allow for simultaneous action?

Rescue efforts should be extended in the following order:

- Most severely threatened
- The largest number (groups)
- The remainder of the fire area
- The exposed areas

A primary search means companies have quickly gone through all affected areas and verified the removal and/or safety of all occupants. Time is the critical factor in the primary search process. Successful primary search operations must be extended as quickly as possible dependent on the conditions and fire suppression actions. The completion of the primary search is reported utilizing the standard radio reporting term "All Clear."

It is the responsibility of Command to coordinate primary search assignments and secure completion reports from interior companies. The tactical benchmark for completing a primary search is "All Clear." Alarm will record the time of the "All Clear" report from Command.

The rescue functions that follow fire control activities or completed after a primary search is completed will be regarded as a secondary search. A secondary search means that companies thoroughly search the interior of the fire area after initial fire control and ventilation activities have been completed. A secondary search should preferably be completed by different companies than those involved in the primary search activities. Thoroughness, rather than time, is the critical factor in a secondary search.

The objective of a secondary search is the confirmation of an "All Clear." This should be reported to the Alarm Room upon completion.

OPERATIONAL INFORMATION

The stage of the fire becomes a critical factor that affects the rescue plan developed by Command. On residential fire incidents, the following items outline the basic Command approach to fire stages:

- In nothing showing situations, or in very minor fire cases that clearly pose no life hazard, Command must structure a rapid interior search and report "ALL CLEAR." The interior search for victims will also include an interior size up for smoke or fire conditions.
- In smoke showing and working fire situations, fire control efforts must be extended simultaneously with rescue operations to gain entry and control interior access to complete a primary search. In such cases, Command and operating companies must be aware that this action is working with greatest allowable risk and is focused on the location and removal of victims. Fire knockdown or control may be a critical factor in completing a primary search. In working fire situations, a primary search must be followed by a secondary search.
- In cases of fully involved buildings or compartments of buildings, a fire attack with adequate water flow becomes the primary focus. A size up must be conducted to determine the ability to search exposed or connected areas if the conditions and building integrity allow. This must be coordinated with the fire attack plan. Clear communications and determination of what areas can be searched in conjunction with fire control and coordinated ventilation is critical. Command must determine which areas will not be

searched due to fire conditions and structural integrity. As quickly as fire control is achieved, Command must structure what is, in effect, a secondary search for victims.

Command and operating companies cannot depend solely upon reports from residents and spectators to determine status of victims. Fire companies should utilize reports as to the location, number, and condition of victims as supporting primary search efforts, and must extend and complete a primary search wherever entry is possible. Search and rescue operations are condition and structure dependent.

In some cases, protecting exposed occupants in a safe location inside the structure is the most appropriate action. These occupants are safer in their rooms than moving through contaminated hallways and interior areas. Such movement may also impede interior firefighting. When these actions are appropriate, this must be communicated to the Sector Officer or Command depending on the size and complexity of the incident.

Command must make specific primary search assignments to companies to cover specific areas of large or complex residential occupancies (e.g., high-rise, mid-rise, large care homes, etc.) and maintain on-going control of such companies until the entire area is searched when conditions allow. When primary search companies encounter and remove victims, Command must assign other companies to continue to cover the interior positions vacated by those companies.

All initial attack efforts must be directed toward supporting rescue efforts and hose lines must be placed in a manner to control interior access, confine the fire, and protect avenues of escape. Hoseline placement and adequate water flows become critical factors in these cases. Command, Sector Officers, and all operating companies must realize that the operation is still focused on the rescue of occupants in coordination with an effective fire attack.

Normal means of interior access (e.g., stairs, halls, interior public areas, etc.) should be utilized to remove victims whenever possible. Secondary means of rescue (e.g., aerial platforms and ladders, ground ladders, fire escapes, helicopters, etc.) must be utilized in their order of effectiveness.

Command must realistically evaluate the resources required to remove victims and then treat their fire-affected bodies. In cases involving such multiple victims, Command must call for the timely response of adequate resources and quickly develop an organization that will both stabilize the fire and provide for the removal and treatment of the occupants. Command must structure treatment of victims after removal. Multiple victims should be removed to one location for more effective triage and treatment. Command should coordinate treatment and assign treatment companies as required to a Treatment Sector.

Once the primary search has been completed and an "ALL CLEAR" transmitted, Command must maintain control of access to the fire area; beware of occupants (and others) re-entering the

building. The most urgent reason for calling additional alarms is for the purpose of effectively managing the life safety potential. Command must develop a realistic (and pessimistic) rescue size-up as early as possible.

The term "SEARCH & RESCUE" should be used when assigning companies to a primary search over the radio; "ALL CLEAR" should be used only as a completion report.

**PHOENIX REGIONAL
STANDARD OPERATING PROCEDURES**

Fire Control

M.P. 202.04

11/14-R

12/17-SR

The following outlines the directives for structural fire control.

PROCEDURE

It is standard operating procedure to attempt to stabilize fire conditions by extending WHEREVER POSSIBLE an aggressive well-placed and adequate offensive interior fire attack. A critical Command decision (both initial and on-going) relates to the Offensive/Defensive Strategy of the situation:

- Offensive Strategy--Interior attack and related support directed toward quickly conducting a search for victims and bringing the fire under control.
- Defensive Strategy--Exterior attack directed to first reduce fire extension and then bring the fire under control.

Command must define Offensive/Defensive Strategy based upon the Risk Management System. In addition, Command will consider the following when Fire Control is the principle objective:

1. Fire extent
2. Structural conditions
3. Entry capability
4. Ventilation profile
5. Rescue profile of occupants
6. Resources profile

The Incident Commander will support Offensive Strategy, aggressive interior attack, with whatever resource and action is required to reduce fire extension and to bring the fire under control. Command must declare which strategy is being used as part of the on-scene report and at each notification of elapsed time.

OPERATIONAL INFORMATION

BASIC OFFENSIVE PLAN

1. Take Command
2. Identify critical fireground factors
3. Establish IRIC
4. First line--fast, aggressive interior attack
5. Provide support activities (e.g., ventilation, forcible entry)
6. Do primary search
7. Second line--backup first/cover opposite side
8. Pumped water
9. Quickly evaluate success and react

BASIC DEFENSIVE PLAN

1. Take Command
2. Evaluate fire spread/write-off lost property
3. Identify critical fireground factors
4. Prioritize fire streams (provide big, well placed streams)
5. Pumped water
6. Quick determination on additional resource needs
7. Surround and drown

PHOENIX REGIONAL STANDARD OPERATING PROCEDURES	
Policy Name: <p style="text-align: center;">LARGE-SPACE BUILDING COLD SMOKE FIRES</p>	Policy Number: <p style="text-align: center;">M.P. 202.04A</p>
This policy is for internal use only and does not expand an employee’s legal duty or civil liability in any way. This policy should not be construed as creating a duty to act or a higher duty of care, with respect to third party civil claims against employees or the Phoenix Fire Department (PFD). Remedies for violations of this policy, if proven, are limited to administrative disciplinary action against PFD employees.	
Related Policies: 201.01A, 201.01B, 201.03, 201.06, 202.05, 202.19, 202.19A, 205.20, 205.20A, 205.02B	
Other Reference: NFPA Fire Protection Handbook, 2018	
Date Implemented: 12/2021-R	Review Date: 12/2026

PURPOSE

The purpose of this procedure is to establish guidelines for regional consistency regarding fire incidents in large-space buildings with fire sprinklers (cold smoke fires). Large-space buildings are structures with big, non-compartmentalized space(s). For example, warehouses, distribution centers, shopping centers, data centers, churches, bowling alleys, gymnasiums, public assembly occupancies, etc. Early incident operations necessitate controlling the advancement of interior companies due to the increased potential of firefighters becoming disoriented. This requires a strong command presence and focus on incident organization, communication, accountability, hose line management, air management, work cycles, etc.

RISK MANAGEMENT

Fire sprinkler systems have over a 100-year history of protecting life and property from the destructive forces of fire. History establishes that civilian fire fatalities in sprinklered buildings of any type are extremely rare. In the absence of a report of people trapped, we can anticipate our actions being focused on property protection and our application of risk management must align as such.

Fire incidents in large-space buildings with fire sprinkler systems expose firefighters to many challenges and hazards. These include but are not limited to:

- Cold smoke refers to smoke that has lost its velocity and flows calmly. In other words, smoke that lacks the speed, turbulence, or energy. Cold smoke is extremely dangerous. The presence of cold smoke identified during size up is significant. Cold smoke can be present with or without fire sprinkler control.

- Regarding large-space buildings, a small amount of smoke from one or more locations can mean a significant fire.
- Factors of storage configuration such as height and type (e.g., rack storage, floor storage). As materials get wet, they get heavier, and packaging can begin to break down causing rack storage collapse.
- Construction features including type, building size, fire rated enclosures, and large opened areas.
- Signs of an incident of any significance will typically require a first alarm or greater response.
- Large open interior spaces typically require truss construction. These large spans and construction methods can lead to early structural collapse if fire is not contained by the fire sprinkler system. Partial roof collapse should be assumed to have compromised the fire sprinkler system.
- Large-space buildings may have atypical roof characteristics that can be challenging for roof operations to include vertical ventilation.
- The types and quantities of materials stored may include hazardous materials.
- Presence, type, and suitability of fire protection and detection systems.
- Methods to facilitate ventilation such as roof vents, sky lights, doors, rollup doors, smoke control and exhaust systems.
- Available water supply and adequacy.
- Fixed and mobile equipment/machines for material handling.
- Warehouses with rolled paper storage are a significant hazard. In 1978, the fire sprinkler system had contained a fire in a warehouse storing large bales of rolled paper. Three Canadian firefighters were killed instantly during overhaul when 600-pound paper rolls became unstable and toppled over burying them.
- If the fire sprinkler system fails to control the fire for any reason, the fire will grow quickly. We should anticipate fire control necessitating defensive operations and exterior fire suppression via master streams outside of the collapse zone.

PRE-INCIDENT PLANNING

Pre-incident planning is critical as information gathered during planning visits before the incident is used by Company and Command Officers during an actual incident. Pre-incident planning allows personnel the opportunity to view conditions and factors within the structure or the site. This allows for an evaluation of how these conditions and factors are likely to develop in the event of an emergency incident. The following should be considered during pre-incident planning for large-space buildings:

- Exterior wall construction: Concrete, metal panel, masonry, wood frame, etc. This information is important as it relates to fire extension potential, exposure protection, collapse, and others.

- Occupancy type: Office, retail, manufacturing, warehouse, etc. Each occupancy has unique factors. Warehouses have rack storage, retail may have large storage areas (to include rack storage areas not immediately evident), manufacturing may have specialized equipment and hazardous materials.
- Many new data centers and other large-space buildings may have battery energy storage systems and/or photovoltaic systems (see M.P. 205.20, 205.20A, 205.02B)
- Roof construction: The type and construction of the roof will impact ventilation. Wood joist, steel joist, steel beam, etc. Decking material, wood plank, concrete, metal panel, etc. Roof covering may have built up tar and gravel or insulated membrane systems. Pre-incident planning should address how ventilation can be accomplished, to include the presence and location of skylights, and any manual or automatic vents.
- Ceilings and attics: False ceilings and common attics can lead to fire spread throughout the structure. False ceilings and common attics can result in fires burning undetected in areas not visible and absent fire sprinklers.
- Interior configuration and storage: Presence and height of rack storage, large-opened spaces, office areas and other separated spaces, fire walls, fire doors, smoke barriers, etc.
- Fire protection systems: Automatic sprinkler systems, fire pumps, special protection systems (e.g., dry chemical, foam, carbon-dioxide, etc.), standpipes, fire alarm systems, smoke control systems, and water supply.
- Site factors: Apparatus access and tactical positioning, security, exposures, utilities, etc.
- Environmental: Runoff from fire sprinklers or other suppression efforts contaminated with hazardous materials must be considered. This should include the location of drainage and collection points as well as other potential exposures.

Premises alerts for rolled paper, hazardous materials, rack storage, and other hazards should be entered into the CAD system when identified during pre-incident planning.

INCIDENT GUIDELINES

Early assessment of the seven sides of the structure is a high priority on these incidents. Size up should include the identification of smoke, flames, or water runoff. Look for signs for fire protection systems and the buildings Fire Department Connection (FDC). Look for a red bell on the outside of the building. If the bell is ringing, water is very likely to be flowing out of the fire sprinkler system. Some systems incorporate horn/strobe notification devices, listen for horns and look for flashing strobes. Also, identify signs of hazardous materials to include particulate scrubbers, containment areas, tanks, NFPA 704 Diamond(s), other signage, etc.

Determining the best access point(s) to the fire necessitates good size up of the building. Ideally, firefighters have an awareness of the building established through pre-incident planning. When operating in interior positions, firefighters must stay on the hose line, no complacency. Conditions can change quickly. Fire companies should recognize the importance of utilization of thermal imaging cameras (TIC), especially on these types of incidents due to the size of the building and

presence of cold smoke. The TIC camera is an excellent tool to support accountability and locating the fire.

All personnel within the incident organization must effectively manage their responsibilities with regard to work cycles, accountability, air management, communication (radio management), hose line management, etc. Companies must not extend hose lines more than 150 feet into the building.

If you cannot find the fire, pull the firefighters out of the building and implement another plan. The Incident Commander must be decisive with making the decision to switch to another plan, understanding the dangers of interior companies operating in a hazardous position with a limited air supply. Once firefighters are out of the building, regroup and implement plan B (this is the Incident Commanders responsibility). Consideration should be given to pumping the FDC and ventilating the building. Cold smoke fires should be approached in a similar manner to a hazardous materials incident, recognizing the hazards and where the incident resides from a risk management perspective. Ventilation options can include the utilization of fans, vertical ventilation, opening sky lights, using specialty building systems, and/or hydraulic ventilation with portable monitors. Ventilation will often utilize a variety of different options coordinated to ensure effectiveness and realizing that ventilation of cold smoke is a slow process.

Pumping the FDC is a good thing. Additional GPM and pressure can have a major positive impact on the effectiveness of fire sprinklers. Remember, every decision made should be coordinated. Prior to pumping the FDC, consider if firefighters are interior and if a sudden increase in volume and pressure may contribute to a rack storage collapse.

Note: Some large-space building fire protection systems are supported by a fire pump. Connecting to the FDC in this instance is a precaution in the event of a fire pump failure.

Conversely, we should not shut down the fire sprinkler system prior to verification of fire control. The outcome of testing after the Southwest Supermarket fire established the maximum distance a fire company will enter any building is 150 feet, without additional support mechanisms put in place by command. For cold smoke fires, if the fire cannot be located or accessed due to 150-foot limitations, command must pull firefighters from interior positions, pump the FDC, and ventilate the building. Command and operating personnel recognize that these tactics will take time. Once smoke has cleared out and we have assurances that the incident has stabilized, fire companies may go deeper than 150 feet into the building, if it is safe to do so. A Shift Commander should be present to review and approve any plan that takes fire companies more than 150 feet in the building. In this instance, a Battalion Chief with a Battalion Safety Officer should be in place to manage the Sector. Remember, the incident commander controls the incident, not the other way around. On cold smoke fires, we shall operate in the correct risk management position. If firefighters cannot reach the fire, pull them out of the building. At this point, time is on your side.

PHOENIX REGIONAL STANDARD OPERATING PROCEDURES	
Policy Name: FIREGROUND SAFETY	Policy Number: M.P. 202.05
This policy is for internal use only and does not expand an employee's legal duty or civil liability in any way. This policy should not be construed as creating a duty to act or a higher duty of care, with respect to third party civil claims against employees or the Phoenix Fire Department (PFD). Remedies for violations of this policy, if proven, are limited to administrative disciplinary action against PFD employees.	
Related Policies: 201.01, 201.05A	
Other Reference: NFPA 1500-2018, NFPA 1521-	
Date Implemented: 12/2021-N	Review Date: 12/2026

PURPOSE

The purpose of this procedure is to establish general safety guidelines for operating personnel.

TACTICAL POSITIONING

Positioning of operating companies can severely affect the safety/survival of such companies. Personnel must use caution when placed in the following positions:

- In the direct flow path of the fire
- Working into wind-driven conditions
- Above the fire (floors/roof)
- Where fire can move in behind or above them
- Where position and retreat cannot be controlled
- When involved with opposing fire streams
- Combining interior and exterior attack
- With limited access--one way in/out
- Operating under involved roof structures
- In areas containing hazardous materials
- Below ground fires (basements, etc.)
- In areas where a flashover or backdraft potential exists
- Above/below ground rescue

The safety of firefighting personnel represents the major reason for an effective and well-timed offensive/defensive decision and the associate write-off by Command. THE TWO STRATEGIES ARE BASED ON A STANDARD RISK MANAGEMENT PLAN THAT IS TO BE EMPLOYED AT ALL STRUCTURE FIRES.

STANDARD RISK MANAGEMENT PLAN

WE MAY RISK OUR LIVES A LOT, IN A CALCULATED MANNER, TO PROTECT SAVABLE LIVES

WE MAY RISK OUR LIVES A LITTLE, IN A CALCULATED MANNER, TO PROTECT SAVABLE
PROPERTY

WE WILL NOT RISK OUR LIVES AT ALL FOR LIVES OR PROPERTY THAT IS ALREADY LOST

When operating in a defensive strategy, operating positions should be as far from the involved area as possible while still remaining effective. Position and operate from behind barriers if available (fences, walls, etc.). The intent is for personnel to utilize safe positioning where possible/available, in an effort to safeguard against sudden hazardous developments such as explosion, structural collapse, down-powerlines, smoke, collision of heavy equipment, etc.

When operating in an offensive strategy, a controlled aggressive attack is required for firefighter safety. An effective, coordinated interior attack operation directed toward knocking down the fire eliminates most eventual safety problems. The operational focus should be to get water on the fire from the most effective position available. Water on the fire improves interior conditions for savable victims and firefighters.

Due to the inherent hazards of the fire or incident scene, efforts must be made by Command to limit the number of personnel on the fireground to those assigned to a necessary function. All personnel shall be:

- Responding
- Positioned in Staging
- Assigned to a task or operating within a sector
- Released to in-service status

The intent of this procedure is to minimize fireground confusion/congestion and to limit the number of personnel exposed to fireground hazards to only those necessary to successfully control the operation. Individuals or crews shall be restricted from wandering about the fireground or congregating in non-functional groups. If personnel have not been assigned to a sector or do not have a necessary staff function to perform, they shall remain outside the fireground perimeter.

When it is necessary to engage personnel in exceptionally hazardous circumstances (i.e., to perform a rescue), Command will limit the number of personnel exposed to an absolute minimum and assure that all feasible safety measures are taken.

In extremely hazardous situations (e.g., flammable liquids, LP gas, special operations, etc.) Command will engage only an absolute minimum number of personnel within the hazard zone. Unmanned fire streams (typically master streams) will be utilized wherever possible.

In situations where crews must operate from opposing or conflicting positions, such as front vs. rear attack streams, roof crews vs. interior crews, etc., utilize radio or face-to-face communications to coordinate your actions with those of the opposing crew in an effort to prevent needless injuries. It is critical that opposing or conflicting operations are avoided whenever possible. Notification and coordination between Company Officers, Sector Officers, and Command is necessary to manage conflicting operations.

Ground crews must be notified and evacuated from interior positions before ladder pipes go into operation. Command or Sector Officers should consider obtaining a PAR prior to ladder pipes going into service.

Do not operate exterior master streams into an area where interior crews are operating. Caution needs to be used if exterior hand line application is flowing water into a compartment where interior crews are operating. This procedure is intended to prevent injuries to firefighters and structural collapse.

When laddering a roof, the ladder selected shall be one which will extend 2' - 3' above the roof line. This shall be done in an effort to provide personnel operating on the roof with a visible means of egress.

If possible, when laddering buildings under fire conditions, place ladders near building corners or fire walls as these areas are generally more stable in the event of structural failure.

The ROCC recommends that personnel should be tethered to a ladder/platform anchorage point on the platform any time the device is in motion and whenever you are off the ground unless you are actively climbing or descending the ladder or entering or exiting the platform.

When operating either above or below ground level, establish at least two separate escape routes/means where possible, (such as stairways, ladders, exits, etc.), preferably at opposite ends or diagonal corners of the building or separated by considerable distance.

Hot Zone

The Hot Zone will be defined as any area that requires an SCBA, charged hoseline, special protective clothing, or in which firefighting personnel are at risk of becoming lost, trapped, or injured by the environment or structure. The following situations would be included inside the Hot Zone:

- Entering a structure reported to be on fire

- Operating in close proximity to an involved structure during exterior operations
- Confined Space
- Trench Rescues
- Operating close to crane operations or close to swift water operations
- Building collapse
- Operating close to helicopter operations
- Extrication

ALL FIREFIGHTERS WORKING IN THE HOT ZONE SHALL BE IN CREWS OF A MINIMUM OF TWO PERSONNEL, WEARING APPROPRIATE PPE, WITH A RADIO ON THE CORRECT TACTICAL CHANNEL AND MUST HAVE AN ASSIGNED TASK OR FUNCTION. THE ACCOUNTABILITY SYSTEM WILL BE IN PLACE.

Warm Zone

The Warm Zone will be defined as the area just outside of the Hot Zone where the firefighters start their operations on the fireground. This zone is where the firefighter is not at risk of becoming lost, trapped, or injured by the environment or structure. The following functions could be done inside the Warm Zone:

- Forward fire apparatus working the incident (e.g., engines, ladders, etc.)
- Laying lines
- Hazmat and TRT developing strategies & tactics
- Utility trucks
- Special equipment needs
- Accountability Officer
- Fire Investigations

If at any time firefighters in the Warm Zone become threatened, this area would become a Hot Zone.

Cold Zone

The Cold Zone will be defined as outside of the Warm Zone where no one is at risk because of the incident. The following functions could be done inside the Cold Zone:

- Command
- Level I & Level II staging
- Support and staff personnel
- Canteen
- Rehab
- Media

All operating personnel must remain vigilant on emergency incidents. Just because your operating in a Cold Zone does not mean there is no risk. Apparatus movements, traffic, and unforeseen violence are just a few examples of potential hazards at all incidents.

No-Entry Zone

The No-Entry Zone is defined as the area at an incident that no person shall be permitted to enter due to an imminent hazard, dangerous condition, or the need to protect evidence. Operating personnel need to be informed of the No-Entry Zone; during nighttime operations consideration should be given to illumination of the No-Entry Zone.

When possible, control zones should be identified with colored hazard tape or other appropriate means parallel to NFPA 1521 guidance.

- Hot Zone: Red
- Warm Zone: Yellow
- Cold Zone: Green
- No-Entry Zone: Red and white diagonal-striped or chevron

SECTORS

The safety of firefighting personnel represents a major reason for fireground sectorization. Sector Officers must maintain the capability to communicate with forces under their command so that they can control both the *position* and *function* of their companies.

Sector Officers and Company Officers shall be able to account for the whereabouts and welfare of all crews/crew members under their assignment.

Company Officers shall insure that all crew members are operating within their assigned sector only. Crews will not leave their respective sectors unless authorized by the Sector Officer.

When crews are operating within a sector, Company Officers shall keep the Sector Officer informed of changing conditions within the sector area, and particularly those changing conditions which may affect the safety of personnel.

Hazards that will affect only a specific sector area should be dealt with within that sector and need not necessarily affect the entire operation.

SAFETY SECTOR

The recognition of situations which present inordinate hazards to fireground personnel and the proper response to safeguard personnel from those hazards is of critical importance to all Fire Department operations.

Command has the responsibility to recognize situations involving a high risk to personnel and to initiate appropriate safety measures.

Command shall establish appropriate additional safety oversight at incidents involving an inordinate danger to personnel. Command may consider establishing a Safety Sector on any situation where it may be advantageous to the overall safety of operations.

When the need for specialized assistance is identified, Command should confirm the response of the appropriate personnel (Safety Officer/Structural Engineer).

Command may designate any available personnel to establish a Safety Sector when the need is indicated. This should be a high priority assignment.

The establishment of a Safety Sector in no way diminishes the responsibility of all officers for the safety of their assigned personnel. Each and every member shall utilize common (safety) sense and work within the intent of established safety procedures at all times.

STRUCTURAL COLLAPSE

Structural collapse has been a major cause of serious injury and death to firefighters. The possibility of structural collapse should be a major consideration in the development of any incident action plan. All fireground personnel should consider the possibility of structural collapse in the decision-making process.

Structural collapse is always a possibility when a building is subject to intense fire. In fact, if fire is allowed to affect a structure long enough, structural failure is inevitable.

Regardless of the age and exterior appearance of the building, the possibility exists that a principal structural supporting member is being seriously affected by heat and may collapse, inflicting serious injury to firefighters.

Example: A 100' length of unprotected steel will expand 9" when heated to 1100° F.

In the typical fire involved building, the roof is the most likely candidate for failure, however failure of the roof may very likely trigger a collapse of one or more wall sections. This is especially true if the roof is a peak or dome type which may exert outward pressure against both the bearing and non-bearing walls upon collapse. In multi-story buildings or buildings with basements, the floor section above the fire may collapse if supporting members are directly exposed to heat and flames.

A knowledge of various types of building construction can be invaluable to all firefighters from a safety standpoint as certain types of construction can be expected to fail sooner than others. For

example, light weight truss and bar joist roof construction can be expected to fail after minimal fire exposure.

Structures have been known to collapse without warning but usually there are indications which may tip off an alert firefighter. Action shall be taken to avert any imminent hazard.

Signs of building collapse may include:

- Cracks in exterior walls
- Bulges in exterior walls
- Sounds of structural movement--creaking, groaning, snapping, etc.
- Smoke or water leaking through walls
- Water accumulation on a roof
- Windows, doors, floors and stairs out of level
- Flexible movement of any floor or roof where firefighters walk
- Interior or exterior bearing walls or columns--leaning, twisting or flexing
- Sagging or otherwise distorted rooflines
- Time of fire involvement

The following construction features or conditions have been known to fail prematurely or to contribute to early structural failure when affected by fire.

Contributing Factors:

- Parapet walls
- Large open (unsupported) areas--supermarkets, warehouses, etc.
- Large signs or marquees--which may pull away from weakened walls
- Cantilevered canopies--which usually depend on the roof for support and may collapse as the roof fails
- Ornamental or secondary front or sidewalls--which may pull away and collapse
- Buildings with light weight truss, bar joist, or bow string truss, roofs
- Buildings supported by unprotected metal--beams, columns, et
- Buildings that are under construction, renovation or are otherwise not completed

Buildings containing one or more of the above features must be constantly evaluated for collapse potential. These evaluations should be a major consideration in determining the strategy, i.e. offensive/defensive.

It is a principal Command responsibility to continually evaluate and determine if the fire building is tenable for interior operations. This on-going evaluation of structural/fire conditions requires the input of Company Officers advising their Sector Officers and of Sector Officers advising Command of the conditions in their area of operation.

Most structures are not designed to withstand the effects of fire and can be expected to fail if exposed to heavy fire involvement. If after 10-15 minutes of interior operations heavy fire conditions still exist, Command should initiate a careful evaluation of structural conditions, and should be fully prepared to withdraw interior crews and change to a defensive strategy.

If structural failure of a building or section of a building appears likely, a No-Entry Zone must be established a safe distance from the area which may collapse. All personnel must remain outside this perimeter.

EVACUATION OF FIREFIGHTING PERSONNEL

Interior firefighting operations should be abandoned when the extent of the fire prohibits control, or the structure becomes unsafe to operate within. When such conditions make the building untenable, evacuate, account for personnel, regroup, recommunicate, and redeploy.

Our primary concern, when a hazard which may affect the safety of fire personnel becomes apparent, is the welfare of those personnel. In an effort to protect personnel who may suffer the adverse effects of hazards such as structural collapse, explosion, backdraft, etc., a structured method of area evacuation must be utilized, one which will provide for the rapid/effective notification of those personnel involved, and one which will be able to accurately account for those personnel.

Crews retreating from interior operations often require hoseline protection. The protection afforded to firefighting personnel in such situations represents a major function of back-up lines.

The method of evacuation selected will vary depending on the following circumstances:

- Imminence of the hazard
- Type and extent of hazard
- Perception of the area affected by the hazard

The "Emergency Traffic" announcement is designed to provide immediate notification for all fireground personnel. The use of "Emergency Traffic" should be initiated only when the hazard appears to be imminent or has just occurred. Any member has the authority to utilize the "Emergency Traffic" announcement when it is felt that a notable danger to personnel is apparent; however, considerable discretion should be applied to its use - emergency traffic announcements become ineffective if overused.

When an imminent hazard has been realized, the emergency traffic process should be initiated. Usually, a Company or Sector Officer will be the initiator. The initiator should describe the apparent hazard and order a suitable response, usually to evacuate a particular area or section, according to the scope of the hazard.

If possible, the Sector Officers of those areas to be evacuated should request an acknowledgment of the emergency traffic dispatch from those crews to be evacuated.

Upon receipt of the emergency traffic evacuation order, Company Officers shall assemble their crews and promptly exit to a safe location, where the Company Officer will report a PAR for all crew members. Shortly after the evacuation order, Sector Officers shall begin the process of accounting for all evacuated crews. When all affected crews and crew members are accounted for, the Sector Officer will report a PAR for that Sector. At this time a more specific determination as to the reality/extent of the hazard can be made and efforts initiated to redeploy/redirect efforts.

Building evacuation generally involves a shift from an offensive to a defensive strategy. In such cases, Command must develop a corresponding operational plan and must communicate that plan to all operating companies. It is extremely important that everyone is notified and recognizes that a shift in strategy has been made. This transition can be time consuming based on company's interior positions.

Hazards of a less than imminent nature should usually be handled by a consultation of Command, Sector Officers, Safety Officers, Company Officers or other personnel. Personnel should make a determination of the nature and possible effect of the suspected hazard and advise Command so that a more well-informed decision can be made.

SEARCH AND RESCUE

Search and rescue should be performed according to an efficient, well planned procedure which includes the safety of search crew personnel. The object of the search effort is to locate possible victims, not create additional ones by neglecting the safety of the search crew.

Fire victims are typically killed through thermal and/or toxic exposure. The closer a victim is to the fire the greater the chance of thermal exposure. Toxic exposure is not directly connected to the proximity to the fire but in any area affected by smoke and the products of combustion. In either form of exposure, the most survivable space in any structure or compartment is at the floor level.

Prior to entering the search area, all search team members should be familiar with a specific search plan including the overall objective, a designation of the search area, individual assignments, etc. This may require a brief conference among crew members before entering the search area to develop and communicate the plan. Individual search activities should be conducted by two or more members when possible.

For residential search and rescue operations, firefighters may search off the hoseline. Company Officers must maintain an awareness of the position and function of all members within their crew

during search operations. For non-residential fire operations, firefighters should not be operating off of the hoseline.

A brief look around the floor below the fire may provide good reference for the search team, as floors in multi-story occupancies usually have a similar layout.

Whenever a search is conducted that exposes search crews to fire conditions (particularly above the fire floor) the search team should be protected with a charged hose line.

STANDARD OPERATING PROCEDURES

THERMAL IMAGING CAMERA DEPLOYMENT

M.P. 202.05A

09/03-N

Page 1 of 2

PURPOSE

The purpose of this procedure is to identify the strategic and tactical approach for the deployment of thermal imaging cameras (also referred to as TIC's).

SIZE-UP

The TIC may provide valuable information during size-up, which can assist the Incident Commander in determining the strategy and formulating the incident action plan. Early identification of tactical priorities/needs can prove beneficial in placing initial and subsequent attack lines. When a company officer or incident commander arrives on the scene, one of the first challenges is to identify the location of the fire. A TIC can save a great deal of time by helping to pinpoint a concentration of heat within a particular area of the building, especially in large commercial or multistory structures. An incident commander, armed with this knowledge, can better direct firefighters regarding their point of entry and plan of attack so as to optimize their resources.

Even before firefighters enter a burning structure, the incident commander or company officer can accomplish a great deal from the exterior with the aid of thermal imaging technology. Some factors that can be assessed from the outside include finding the seat of the fire, observing changing or spreading conditions, identifying critical building construction features and identifying conditions that could threaten structural integrity. A sector officer will also benefit from this information in assessing the operational objectives, progress and needs within the sector.

DEPLOYMENT

The early and rapid deployment of the Thermal Imaging Camera (TIC), while operating in an Offensive Strategy, may enhance the visibility in a visibly diminished atmosphere, thus increasing fire fighter safety and survival, as well as improving the survival potential of our customers.

The TIC can also be deployed while operating in a Defensive Strategy. It can provide the Incident Commander or Company Officer with valuable information during size-up. Early identification of structural compromise, fire location in the structure, e.g. attic, and identification of severely threatened exposures would provide valuable information when determining the strategy. This information would also aid in identifying key tactical positions/needs. By deploying a TIC to the exposures, information could be obtained as to the extent of impingement to the exposed structure, early identification of avenues of fire spread and possibly any hot spots, which could cause extension.

It shall be the responsibility of the Company Officer/Command to rapidly deploy the TIC in a visibly diminished atmosphere or in an atmosphere that may suddenly become visibly diminished.

STANDARD OPERATING PROCEDURES

THERMAL IMAGING CAMERA DEPLOYMENT

M.P. 202.05A

09/03-N

Page 2 of 2

PRIMARY APPLICATION

The primary use of the TIC for the fire department is for conducting search/rescue and crew accountability tasks. The use of a TIC can prove to be a useful tool during search and rescue tasks by reducing the amount of time it may take using standard search techniques. This will lead to a more effective and organized search, while quickly identifying the fire. By locating the fire quickly, we will better be able to determine our tactical priorities and rescue priorities (do we remove the victims from the fire or remove the fire from the victims).

The TIC will enhance the ability to maintain crew accountability by increasing the vision capabilities of the operator/Company Officer. This will ultimately lead to enhanced fire fighter safety while working in a hostile environment. **This does not replace the accountability tasks required of the captain and each individual operating on the fireground. We must stay together in complex situations and/or structures in order to enhance our survival.**

While the TIC may enhance the operation of the crews on the fireground, it is imperative to realize, that with any tool, there are limitations. TIC deployment into the operation should not propagate a sense of security. Crews and TIC operators must be aware that the TIC may malfunction and sole reliance on the camera is not prudent fire fighting. Additionally, it should not replace or violate the core of our experience, training, safety procedures, or standard fire fighting practices/principles. As always, safety must be the top priority.

**PHOENIX REGIONAL
STANDARD OPERATING PROCEDURES**

SELF-CONTAINED BREATHING APPARATUS

M.P. 202.05B

01/21-R

Page 1 of 2

It is the policy of the Phoenix Fire Department that all personnel expected to respond and function in areas of atmospheric contamination, shall be equipped with self-contained breathing apparatus (SCBA) and trained in its proper use and maintenance.

Members shall achieve a NON-LEAKING facepiece-to-skin seal WITH THE MASK. Facial hair shall not be allowed at points where the SCBA facepiece is designed to seal with the face. INDIVIDUAL MEMBERS SHALL BE ACCOUNTABLE FOR COMPLIANCE WITH THIS REQUIREMENT.

Each member of the Operations Division shall be accountable for one SCBA and shall check the condition of that SCBA at the beginning of each shift, after each use, and at any other time it may be necessary to render the equipment in a ready state of condition. Each member shall be accountable for their personal facepiece and regulator. Each member is also required to undergo a physical examination annually if they are expected to respond and function in areas of atmospheric contamination.

Company Officers shall assign a specific SCBA to each crew member. Each crew member will be responsible for the proper use and function of that SCBA.

If a SCBA is found to be functioning improperly, it shall be taken out of service, red tagged, reported, and replaced immediately. Replacement SCBAs shall be obtained from Resource Management or from the on-duty RM50 Captain after normal business hours.

The intent of the SCBA policy is to avoid any respiratory contact with products of combustion, super-heated gases, toxic products or other hazardous contaminants.

The use of breathing apparatus means that all personnel shall have facepieces in place, breathing air from the supply provided. Where appropriate, Airline-Supplied Breathing Apparatus may be used in place of SCBA.

SCBA SHALL BE USED BY ALL PERSONNEL OPERATING:

- **IN A CONTAMINATED ATMOSPHERE**
- **IN AN ATMOSPHERE WHICH MAY SUDDENLY BECOME CONTAMINATED**
- **IN AN ATMOSPHERE WHICH IS OXYGEN DEFICIENT**
- **IN AN ATMOSPHERE WHICH IS SUSPECTED OF BEING CONTAMINATED OR OXYGEN DEFICIENT**

This includes all personnel operating:

- In an active fire area
- Directly above an active fire area
- In a potential explosion or fire area, including gas leaks and fuel spills

**PHOENIX REGIONAL
STANDARD OPERATING PROCEDURES**

SELF-CONTAINED BREATHING APPARATUS

M.P. 202.05B

01/21-R

Page 2 of 2

- Where products of combustion are visible in the atmosphere, including vehicle fires and dumpster fires
- Where invisible contaminants and/or carcinogens are present, suspected to be present, or may be released without warning
- In any confined space which has not been tested to establish respiratory safety
- Engineers or apparatus operators in a contaminated atmosphere or one that may become contaminated

In addition to the above, SCBA shall be worn by all personnel operating at fire incidents above ground, below ground or in any other area which is not, but which may become contaminated by products of combustion or other hazardous substances. In these circumstances only, the SCBA may be worn with the facepiece removed. The wearing of SCBA in these situations provides that it will be immediately available for use if conditions change or if personnel are to enter an area where the use of SCBA is required.

Premature removal of SCBA must be avoided at all times. This is particularly significant during overhaul when smoldering materials produce increased quantities of toxic substances including carcinogens. Firefighters should be mindful that exposure to products of combustion, such as smoke, does not require visible conditions.

If there is any doubt about respiratory safety, SCBA use shall be maintained until the atmosphere is established to be safe by testing. Hazard or Safety Sector personnel are typically responsible for this determination. This is required in complex situations, particularly when toxic materials may be involved.

An evaluation of all members of the Operations Division in the use of the SCBA should be conducted annually. Each member shall be able to demonstrate a high level of proficiency and compatibility with the SCBA under conditions which simulate those expected as a job requirement. Each member shall also demonstrate an effective facepiece to skin seal of the SCBA facepiece.

**PHOENIX REGIONAL
STANDARD OPERATING PROCEDURES**

Air Management

M.P. 202.05C 01/18 Page 1 of 6

Purpose

The following procedure outlines the “Rule of Air Management” to be employed by all members while operating in the hazard zone of an incident. The practice of working in the hazard zone until the low air alarm sounds and then leaving is an extremely dangerous situation.

As firefighters, we are responsible for our own safety and the safety of our fellow firefighters. The ability to manage our individual air supply and consumption is critical to the safety of every member working in the hazard zone. A poor decision in air management will adversely affect the individual firefighter as well as every firefighter involved in attempting to rescue that firefighter.

History

Historically, most working fires that the Phoenix Regional Dispatch System have responded to were single and multiple family residences. These structures are typically smaller in size with easy egress to the exterior. Firefighting in these “typical” residential structures resulted in a decreased focus on air supply management. When the practice of working until the low air alarm activates and then exiting is applied to fires at commercial occupancies there can be life threatening consequences.

The Phoenix Regional Dispatch System has experienced multiple incidents that have involved air supply emergencies. These incidents have typically ended with a successful intervention and have not changed the overall approach to air management. After Bret Tarver’s death at the Southwest Supermarket fire in 2001, the Phoenix Fire Department conducted numerous training exercises to examine the causes and possible solutions for life threatening emergency situations during commercial and/or “big box” fires. The exercises concluded that when the low air alarm is activated, the firefighter can travel less than 150 feet in good conditions until the air supply is exhausted. In this time, if a firefighter experiences an emergency situation (loses contact with his/her hose line, becomes entangled in wires, or becomes disoriented) the possibility of surviving the encounter is significantly reduced.

Rule of Air Management

It is the individual firefighter’s responsibility to be aware of the amount of air in his/her SCBA and his/her rate of consumption. All firefighters are responsible for managing their own air in order to leave the hazard zone before the low air alarm activates.

**PHOENIX REGIONAL
STANDARD OPERATING PROCEDURES**

Air Management

M.P. 202.05C 01/18 Page 2 of 6

Firefighters should leave the hazard zone with an emergency reserve, much like ocean divers. It is critical for firefighters to understand that the last 33% of the air supply in an SCBA is the emergency reserve. The initial 66% of air supply is the working and exiting air supply. This includes gaining access, working toward the tactical objectives and leaving the hazard zone. If an emergency situation is encountered, the emergency reserve (remaining 33%) air supply is to be used to exit or survive until assistance can arrive. These percentages are appropriate whether it is 2216psi, 3000psi or 4500psi SCBA bottle. The estimated working time for any SCBA is dependent on a number of factors. These include the intensity of the work and the fitness of the firefighter. Each individual firefighter should be cognizant of their air consumption in order to safely follow this rule of air management.

Company officers must be cognizant their crew's air consumption. The company officer must plan for the crew's exit time based physical exertion, distance required to exit to a safe atmosphere and the remaining air pressures that are reported by the individual firefighters. It is the individual firefighter's responsibility to continually assess and report his/her air consumption to his/her company officer.

Strategic Level Air Management:

The safety and welfare of all firefighters operating in the hazard zone falls directly to the Incident Commander. The strategic level of air management is an ongoing process until the hazard has been eliminated or all firefighters have successfully exited the hazard zone. Air management is an important critical operating procedure related to the survival of every firefighter. Although the incident commander is unable to directly manage that survivability profile, procedures and resources should be utilized to directly support the firefighter's safety and welfare.

It is imperative that command continually evaluates the incident using the standard hazard zone decision making model. Operating in an offensive strategy is the most dangerous position for firefighters. Air management must be a major factor of that assessment. The ability of firefighters to exit the hazard zone with a reserve of 33% air is a requirement. If crews are unable to complete their assigned task with that air supply intact, it is necessary for the incident commander to provide an adequate number of companies to replace those initial working crews or change the strategy to defensive.

The strategic level of air management should be managed similarly to the accountability of all members operating in the hazard zone. Both are managed through position and function within a command system. Command provides for improved management of firefighter welfare with early sectorization of the incident. Sector officers should manage the individual sector tactical

**PHOENIX REGIONAL
STANDARD OPERATING PROCEDURES**

Air Management

M.P. 202.05C 01/18 Page 3 of 6

benchmarks and crew welfare within the sector. Company Officers should manage the welfare of their crew. Each firefighter is ultimately responsible for his/her own welfare.

The policy of air management for the Regional Operations Consistency Committee (ROCC) is; it is unacceptable to leave the hazard zone with low air alarms activated during normal operations.

This policy requires firefighters to leave without using their emergency reserve. This policy will require that command and sector officers pessimistically forecast the resources required to complete the tactical objectives in each. Fire crews are less apt to leave an operating tactical position if there are no crews in position to replace them in the incident operation. It is the Company Officer's responsibility to manage the welfare of his/her crew; command must support these crews with adequate replacement resources. The intent is not to adversely impact the active firefight, but to strengthen firefighting operations with crews that have safe air levels. Companies can be assigned only as fast as they arrive. A pessimistic approach would provide needed replacement crews sooner, thus enabling them to follow the air management procedures. These resources should be layered in as either working, on-deck or recycling.

Time is a significant factor in both fire involvement and the air management of crews operating within the hazard zone. It is impossible for the strategic level to manage the individual operating times of all sectors or crews operating within the hazard zone. Each sector officer is required to manage the time crews operate inside the hazard zone within their sector. The strategic level will manage the entire elapsed time for the incident and the effect time has on the structure or hazard.

Tactical Level of Air Management

Captain Level Sector Management

In the initial stages of rapidly escalating fire incidents, company officers assume the role of the initial sector officer and are responsible for the tactical level air management of the sector. The first Captain to the area will typically remain working with his/her crew and will manage the tactical objectives for the sector and task level operations for his/her company. As other companies are assigned to that sector, the initial sector officer will be at a disadvantage in attempting to manage the welfare (specifically the air consumption) of those crews. The initial sector officer will need support from all captains in that sector to closely manage their crew's air. As the incident escalates, command must assign a tactical level Chief Officer to manage the sector operations.

**PHOENIX REGIONAL
STANDARD OPERATING PROCEDURES**

Air Management

M.P. 202.05C 01/18 Page 4 of 6

Battalion Chief Level Sector Management

The tactical level of fireground operations has more direct control of individual crew air management (specifically the air consumption time) than the incident commander. However, the sector officer is often required to manage the sector operations from just outside the hazard zone. This requires close management of work cycles and accountability in order to actively monitor crew air supplies. This is done by the team of the Battalion Chief and the Field Incident Technician (F.I.T.) or Incident Safety Officer (I.S.O.). Typically, the F.I.T. / I.S.O. will monitor the work/rest cycles of operating companies within the sector while the Battalion Chief manages the completion of the tactical objectives. One of the many responsibilities of the F.I.T. / I.S.O. includes monitoring the time operating within the hazard zone and providing reminders to crews of elapsed times on SCBA air.

It is necessary for sector officers to perform their own hazard assessment and apply the standard decision-making model within their portion of the overall incident. This assessment verifies the overall risk management and strategy from the tactical viewpoint. It should also ensure that the actions within the sector match the strategy and risk management profile of the overall incident. The sector officer must define where the crews will operate in the building and what tasks need to be completed. These actions have to be balanced with air management and a well communicated exit plan.

Sector officers must provide pessimistic reports to command regarding resources needed to provide uninterrupted work cycles within the sector. This is necessary until the tactical benchmarks are met within that sector. It is important to have ample crews to provide immediate relief to crews that have diminished their air supply. This requires maintaining adequate "on-deck" resources. Adequate "on-deck" resources provide crews to cycle into the hazard zone as well as crews that are ready to react to a "Mayday". Early forecasting of necessary resources will provide command with the information needed to establish resource requirements for the overall incident.

There is no greater concern for sector officers than the welfare of crews working within the sector. Crew air management is a critical factor in determining the risk management of an operating sector. If critical fireground factors or the ability to manage air supplies change negatively, then this should be communicated to command and a re-evaluation of the strategy should be conducted.

Task Level Air Management

Individual firefighter air management is the foundation of this air management policy. No incident command system or structure can overcome a lack of individual firefighter air

**PHOENIX REGIONAL
STANDARD OPERATING PROCEDURES**

Air Management

M.P. 202.05C 01/18 Page 5 of 6

management. The policy is to leave the hazard zone prior to the SCBA low air alarm sounding. This leaves an emergency reserve of 33% air capacity if an emergency situation arises. Firefighting operations, at all levels, should revolve around this standard.

Personal accountability for the SCBA is critical. Firefighters are expected to manage their assigned SCBA for the entire work shift. This requires thoroughly checking the SCBA prior to shift, after using it, and whenever the functionality is in question. Firefighters are expected to know the air level of their SCBA prior to entering the hazard zone, during firefighting activities and upon leaving the hazard zone. This standard has been known as a “round trip ticket”. The ability to monitor this supply during firefighting activities is a learned skill/habit. It is necessary that company officers reinforce the need to adhere to work cycles to their crews. Command and sector officers should ensure confidence that the work will continue while the relieved crews are refilling and returning to on-deck in their sector.

Air management is critical to individual firefighters as well as to their crew and company officer. The company officer is responsible for the management of air for the entire crew. It is the responsibility of the individual firefighter to monitor his/her air supply and to communicate this with the Captain. Captains are expected to be proactive and inquire about the air level status of their crew. Captains should incorporate the use of triggers to assess their crew’s air supply. These can be the announcement of the completion of tactical benchmarks, elapsed time notifications or built in 50% notification alarms on some SCBA manufacturers. The use of triggers is a learned skill and will require consistent training and practice. Captains can only address situations that they are aware of. The communication of individual air levels is critical.

Low air emergencies or other mayday events pose an extreme danger to firefighters involved in rescue efforts. Data obtained from training exercises after the Southwest Supermarket fire indicates that it takes 12 rescuers to remove one firefighter in a “MAYDAY” situation. The data also demonstrated that one out of every five rescuers will end up having a “MAYDAY” situation and require assistance exiting the hazard zone. This creates a deadly cycle. Air management at all levels of command as well as individual firefighter responsibility is critical in the prevention of these situations. If members believe themselves or other members to be in this situation, the call for a “Mayday” should be immediate.

One requirement for a firefighter to be “MAYDAY” ready is that they are able to effectively don, doff and manipulate the PASS Device and the emergency bypass on their SCBA valve with gloved hands. This is also a learned skill that is perishable if not trained on consistently. This is the standard established in NFPA 1500.

Fire crews operating inside structures should always have an “exit plan”. This is not just the responsibility of the Captain. The Captain should communicate to the crew his/her exit plan.

**PHOENIX REGIONAL
STANDARD OPERATING PROCEDURES**

Air Management

M.P. 202.05C 01/18 Page 6 of 6

The individual firefighters are responsible for maintaining awareness of the plan and how to execute the plan. The plan defines how the crew is going to leave their area of operation (hazard zone). The best plan includes leaving the hazard zone following the hose line out that you came in on. This includes normal operations as well as emergency situations. The plan should include the entrance taken into the building, the dedicated hose line, knowledge of other means of egress within the sector and other crews operating in the sector. This plan also includes the amount of air it takes to leave the hazard zone prior to the low air alarm sounding. The larger the building, the more important and difficult the exit plan becomes.

The results of the testing after the Southwest Supermarket has stated that the maximum distance a fire crew will enter any building is 150 feet without additional support mechanisms put in place by command. This defines only the distance into the building. This does not account for the air it takes to maneuver a hand line into this position. The effort required (air consumption) to place lines in operational positions inside the building is critical to managing air and time operating inside the hazard zone. Crews and company officers must account for this effort within their entrance and exit plans from the hazard zone.

There is one air management policy for residential and commercial occupancies of all sizes for the Regional Operations Consistency Committee (ROCC). Command, sector officers, fire crews and individual fire department members are expected to manage their air supplies in the same manner on all types of incidents.

**PHOENIX REGIONAL
STANDARD OPERATING PROCEDURES**

Roof Sector

M.P. 202.06

09/18

Page 1 of 3

Purpose

This procedure identifies the responsibilities and objectives of the Roof Sector.

Properly coordinated vertical ventilation of a building is important to the success of fire control operations and the safety of firefighters and victims.

Command should establish a Roof Sector during offensive fire operations to evaluate roof conditions and to complete vertical ventilation. Ladder companies should be strategically placed to allow safe access to the roof, emergency exit from the roof, and in tactical positions that would permit effective defensive operations if needed. Roof Sector responsibilities will be assigned to company or chief officers who must be on the roof to supervise crews.

Safe Roof Sector operations are paramount. Roof Sector crews must enter the roof from an established safe area and should have a secondary means to escape the roof, or to a safe refuge on an unexposed and structurally sound roof surface. The Roof Sector will be responsible for obtaining its own protective hose line as needed.

The first personnel reaching the roof must quickly evaluate conditions to assure the roof is structurally sound before attempting to work on it. The degree and extent of any signs of weakness must be considered before committing personnel above the fire. Once on the roof, the sector officer and sector personnel must evaluate their route and progress as they proceed out on the roof. A constant re-evaluation of roof safety must be maintained throughout roof operations. Time and fire conditions will be constantly working to weaken the roof.

The Central Arizona Life Safety System Response Council (CALSSRC) has a minimum standard operational procedure for the safe and efficient vertical ventilation operations. Crews must be familiar with the procedure and all actions on the roof must adhere to the procedure. These procedures specify type and size of the vent hole(s), sequence of cuts, and clearly define the roles of individual crew members.

Commercial vs. Residential

There is a distinct difference in construction design between commercial and residential roof systems and it is important that Roof Sector is aware of the differences that potentially have an impact on roof operations.

**PHOENIX REGIONAL
STANDARD OPERATING PROCEDURES**

Roof Sector

M.P. 202.06

09/18

Page 2 of 3

Bowstring Roofs

No fire fighter shall operate on or under a bowstring roof if there is any evidence that the fire has penetrated the attic, involves the trusses or the structure in anyway. When the fire involves a room or contents with no evidence of structural extension, a quick, aggressive, offensive strategy is appropriate.

Metal Roofs

Buildings with metal roofs have the potential to limit roof operations if the pitch of the roof as determined by the Ladder Company Officer assigned to ventilation, is too steep to safely operate on. Once the Ladder Company Officer evaluates the roof, the decision to operate on it or not will be communicated to Command.

Residential Tile Roofs

No fire fighter shall operate on the roof of a residential structure fire covered with concrete roof tiles. Alternatives to roof (vertical) ventilation should be addressed.

Commercial Tile Roofs

CALSSRC has a standard operation for the safe and efficient vertical ventilation operations on commercial tile roofs. Crews must be familiar with this standard operation and all actions on the roof must adhere to this operation (see <http://www.phoenixfireops.com/ladder-ops> for more information). Extreme caution must be used when operating on commercial tile roofs.

Roof Sector Duties

The initial Roof Sector Officer must report to Command the following conditions:

- Roof design and construction (e.g. flat, peaked, bowstring, etc.)
- Decking material (i.e. wood, metal, or concrete)
- Structural conditions (effects of fire on roof)
- Smoke/fire conditions
- Locations of fire walls and presence of skylight
- Locations of heavy objects that are affected by fire conditions
- Ventilation plan

**PHOENIX REGIONAL
STANDARD OPERATING PROCEDURES**

Roof Sector

M.P. 202.06

09/18

Page 3 of 3

The objectives for Roof Sector operations include:

- Determining a safe working surface
- Complete ventilation cuts to achieve effective ventilation
- Coordinate/Communicate roof (vertical) ventilation with interior crews
- Coordinate roof fire control operations as directed by Command
- Maintain roof-top monitoring of roof structure and fire conditions; during vertical ventilation operation and exit the roof as soon as vertical ventilation objectives are achieved
- Provide progress reports to Command.

It may be necessary to establish a Roof Sector in a position remote from the fire-involved roof to keep a watchful eye on roof conditions, where imminent collapse will occur. Such a location may be an elevated ladder platform or adjacent building.

Vent holes should not be made larger. Once a standard size ventilation hole is cut and cleared, the crews must move away from that area. In some cases, more than one hole will be required to sufficiently ventilate the structure. As one hole is opened, the Roof Sector should cut additional holes a safe distance away. Crews must move from the first hole towards safer areas with each consecutive ventilation hole.

Caution. Additional holes consume time. The Roof Sector Officer must constantly evaluate the structural stability of the roof as it relates to changing fire conditions and time.

The Roof Sector officer must monitor the radio at all times.

The Roof Sector Officer must advise Command when ventilation holes are completed and report on the fire conditions in the structure below the vent hole. This report should include the following:

- Presence or absence of fire in the attic (if there is no fire in the attic, then presence of active fire)
- If no fire then smoke conditions (e.g. heavy, light, none, etc.)
- Any change in the roof conditions and/or structural stability

All Roof Sector personnel shall wear full protective clothing and equipment when operating above a fire. SCBA with face pieces connected will be worn at all times while operating above a fire.

**PHOENIX REGIONAL
STANDARD OPERATING PROCEDURES**

Resource Sector

M.P. 202.07

11/14-R

12/19-SR

The Resource Sector is established as a supply pool to provide a standby supply of equipment for operating sectors. The Resource Sector provides an identifiable location at which available supplies are assembled to provide immediate support when required. Resource Sector is also responsible for having the immediate area checked for equipment which may have been left at the scene upon termination of the incident.

POLICY

Command is responsible for identifying the need for establishment of a Resource Sector and assigning its implementation. This requires the assignment of a Resource Sector Officer and sufficient personnel to operate the Resource Sector as outlined below.

OPERATIONAL INFORMATION

The Resource Sector should be established in close proximity to the scene of operations, but outside of the defined fireground/medical incident perimeter in a safe location.

For high-rise operations, the Resource Sector is normally established five floors below the on-deck floor or any other safe, uncontaminated environment below the fire. Command may identify the location of the Resource Sector or direct the assigned Resource Sector Officer to find and announce an appropriate location. The Resource Sector Officer should locate an area large enough to meet the foreseeable needs of Resource Sector, which may be much larger than initial needs would dictate (this will avoid congestion and the need to relocate).

The Resource Sector exists to provide support to operating sectors. This requires anticipation of equipment and/or personnel which will be needed.

The Resource Sector Officer should attempt to identify the types of equipment and supplies which will be required for the situation and provide delivery to the Resource Sector. This often involves moving tools and equipment from apparatus in Staging to the Resource Sector. Typical supplies involved include spare air bottles, hose, nozzles, hand tools, blowers, lights and loss control equipment. For major medical incidents; backboards, c-collars, oxygen, and associated equipment should be assembled.

The Resource Sector will maintain an inventory of equipment and supplies at all times. The Resource Sector Officer will assign sufficient personnel to provide for adequate support within the sector, including necessary movement of equipment. Equipment areas in the resource pool should be grouped by type, denoting equipment that is ready for use and equipment that is depleted.

In high-rise fires, the radio designation "Resource" should include the floor number that Resource is located on (e.g., "Resource 25"). This will assist firefighting forces in locating Resource Sector within the building. Communications will involve interaction with Command and Staging to provide supplies to the Resource Sector (in a high-rise incident, Lobby Sector will also be involved). Operating sectors may obtain equipment by direct communication with "Resource."

**PHOENIX REGIONAL
STANDARD OPERATING PROCEDURES**

REHABILITATION SECTOR

M.P. 202.08

06/19-R

Page 1 of 5

It is the policy of the Phoenix Fire Department that no member will be permitted to continue emergency operations beyond safe levels of physical or mental exertion. The intent of the Rehabilitation Sector is to prevent the risk of injury that may result from extended field operations under adverse conditions.

PROCEDURE

The Rehabilitation Sector, radio designation REHAB, will be used to evaluate and assist personnel who could be suffering from the effects of sustained physical or mental exertion during emergency operations. Rehab Sector will provide a specific area where personnel will assemble to have:

1. Assessment of vital signs
2. Revitalization - rest, hydration, refreshments, and temperature regulation
3. Medical evaluation and treatment of injuries, if needed
4. Transportation for those requiring treatment at medical facilities
5. Reassignment as needed

NOTE:

The Rehab Sector Officer is responsible for the accountability of crews assigned to Rehab Sector. Members assigned to Rehab do not report back to their previously assigned sector. To be reassigned to another sector, they must be assigned by Command after being cleared by Rehab.

A Rehab Team concept will be used wherever possible to establish and manage the Rehab Sector. This team shall consist of:

1. Rehab Truck
2. Utility Truck
3. Rescue
4. ALS Company
5. Designated Sector Officer
6. C959, as needed
7. Health Center officer, as needed

A Rehab truck will be dispatched on all First Alarm and greater incidents when heat stress advisory is in effect. It will be the responsibility of the Incident Commander to make an early determination of incidents requiring Rehab Sector.

It may be necessary to establish more than one Rehab Sector. When this is done, each sector will assume a geographic designation consistent with the location at the incident site, i.e. Rehab South, Rehab North.

**PHOENIX REGIONAL
STANDARD OPERATING PROCEDURES**

REHABILITATION SECTOR

M.P. 202.08

06/19-R

Page 2 of 5

City buses may also be called to the incident scene to provide cooling or shelter.

Rehab sector should be located in functional location for crew access. In smaller incidents, a utility truck may be all that is required. It is the responsibility of the Rehab Sector Officer and/or Command to determine resources for the sector.

The Rehab Sector area boundaries will be defined and will have **only one** entry point. It will be divided into the following four Functions:

Function A: Assessment

This is the initial entry point and assessment area. Members arriving at the entry point will remove their Personal Protective Equipment prior to entry. Rehab Sector is responsible for the continuation of Accountability and will assign a member to collect passports from crews and take a pulse rate on all crew members. The purpose of this area is to identify any member who may be in need of more attention than just a recovery period. If a member enters with no symptoms of overexertion and vitals in normal range, may return to duty without further evaluation after REHAB. Any member who has a pulse rate greater than 120 will be recorded and tracked thru the rehab sector. The member will proceed to rehydrate and rest with their crew members and be re-evaluated for pulse rate after 20 minutes. If a member enters Rehab with ALOC or irregular heartbeat they will immediately receive ALS treatment. If after 20 minutes of rest and hydration the members pulse is still above 120bpm or signs and symptoms of dehydration then they will receive ALS interventions based on guidelines of Section C.

Function B: Hydration and Replenishment

Rehab personnel will provide supplemental cooling devices (active and/or passive cooling or warming as needed for incident type and climate conditions, fluid and electrolyte replacement, and the proper amount of nourishment.

Function C: Medical Treatment and Transport

ALS crews and a Rescue will manage this function. Here members will receive evaluation and treatment for over exertion and injuries. The crews assigned will follow standard ALS Protocol and advise the Rehab Sector Officer of the need for medical treatment and / or transportation requirements of personnel due to physical condition.

1. Vital Signs & Assessment Standards for REHAB: The ALS crew in this section will pay close attention to the members:

Physical Observations:

1. Personnel complaining of chest pain, dizziness, shortness of breath, weakness,

**PHOENIX REGIONAL
STANDARD OPERATING PROCEDURES**

REHABILITATION SECTOR

M.P. 202.08

06/19-R

Page 3 of 5

nausea, or headache.

2. General complaints such as cramps, aches and pains, rate of perceived exertion
3. Symptoms of heat or cold related stress
4. Changes in gait, speech, or behavior
5. Alertness and orientation to person, place and time
6. Skin Color
7. Obvious Injuries

To be reassigned – Members must have:

A heart rate below 100 bpm with no irregular beats

Systolic BP below 160

Diastolic BP below 100

Respiratory rate between 12-20 per minute

No abnormal neurological findings. (see below)

No complaints

a. Heart Rate Values (HRV) -normal resting pulse rate is between 60 and 100 bpm. At no time will an emergency responder be allowed to return to duty until the pulse rate is below 100 beats per minute after 20 minutes of rest. Members with a HRV over 100BPM after 20 minutes will receive ALS evaluation and treatment per standard medical protocol.

b. Respiratory Rate (RR) - normal value is a rate between 12-20 breaths per minute. Before personnel are returned to duty they should have a respiratory rate that falls within normal values. Persons with a persistent respiratory rate greater than 20 breaths per minute after 20 minutes of rest shall receive ALS evaluation and treatment per standard medical protocol.

c. Blood Pressure (BP) - Upon recovery in rehabilitation a blood pressure should return to, or even be slightly lower than their baseline. Personnel with a systolic pressure greater than 160 and / or a diastolic greater than 100 after 20 minutes in Rehab must go thru an ALS evaluation. Rehab sector will follow appropriate treatment protocols based on the findings of the ALS evaluation.

d. Neurological Assessments- personnel not alert and oriented to person, place or time, and/ or who exhibit changes in gait, speech or behavior, and/ or other persistent abnormal neurological findings shall receive ALS evaluation and treatment per ALS protocols without waiting for the above mentioned 20-minute rest.

e. Skin and Body Temperature- The following skin symptoms require additional evaluation.

**PHOENIX REGIONAL
STANDARD OPERATING PROCEDURES**

REHABILITATION SECTOR

M.P. 202.08

06/19-R

Page 4 of 5

I. Heat Stress-Personnel with skin that feels hot to the touch, dry, red, bumpy rash or is blistering.

II. Cold Stress- When skin is pressed turns red then purple, then white and is cold, looks waxy, feels numb or has a prickly sensation are experiencing signs of frostbite.

III. Body Temperature- For personnel with body temperatures greater than 99.5F after 20 minutes may be not returned to duty and will be transported to a hospital for further evaluation. (Note: Oral measurements are approximately 1.0 degree F or 0.55 degree C lower than the normal Core Body Temperature. Oral Temperatures are subject to error with tachypnea / hyperventilation. Tympanic Measurements may be up to 2.0 degrees F or 1.1 degree C lower than core body temperature.) Cooling measures as appropriate should be implemented.

f. Pulse Oximetry- Values must be above 92% or personnel will not be allowed to return to operations. Persons with a persistent pulse oximeter value below 92% after 20 minutes of oxygen therapy and rest will receive ALS evaluation and treatment per standard medical protocol. (*Note: High readings may also be indicative of Carbon Monoxide saturation.*)

g. Blood Glucose/Sugar (BGS) - will be assessed whenever abnormal neurological findings are observed. If abnormal, treat as per PFD protocol.

h. Electrocardiogram (EKG) Monitoring and 12 Lead EKGs- Responders with a persistent heart rate over 100 BPM after 20 minutes of rest shall receive a 12 lead EKG, ALS evaluation and treatment as needed. Members with an irregular pulse will require ALS Treatment irregardless of time in Rehab sector.

FUNCTION D: Documentation

Time-in and time-out for members/crews entering or leaving the rehabilitation area shall be tracked with vitals. Any member requiring further evaluation beyond 20 min will be documented on an EMS patient care report. Where emergency medical care is provided, an EMS Patient Care Report shall be generated and a copy placed in the member's employee health record.

FUNCTION E: Reassignment

On greater alarms, Health Center staff officer may be available in this section. This critical section determines a crews' readiness for reassignment. Diligent efforts and face-to-face communication with the Rehab Sector Officer are required. Rehab crews will advise the Rehab Sector Officer of all companies' status for reassignment and crews that are running

PHOENIX REGIONAL
STANDARD OPERATING PROCEDURES

REHABILITATION SECTOR

M.P. 202.08

06/19-R

Page 5 of 5

short or without a company officer. This information is relayed to Command by the Rehab Sector Officer.

The Rehab Sector Officer will update Command throughout the operation with pertinent information including the identities of companies in Rehab, the companies available for reassignment, and the status of injured personnel off the tactical channel. All personnel leaving Rehab will retrieve passports from the Rehab Sector Officer.

Company Officers **must** keep crews intact and report to Rehab. The Rehab Sector Officer will direct the crew on arrival; however, it is the Company Officer's responsibility to make sure crew members receive refreshments, treatment if required, and rest and a medical clearance prior to re-assignment or return to duty.

**PHOENIX REGIONAL
STANDARD OPERATING PROCEDURES**

SUPPORT ACTIVITIES

M.P. 202.09

10/99-R

Page 1 of 2

Tactical support activities are those functions that assist active fire control and rescue operations. They generally include forcible entry, ventilation and the provision of access. Most confusion on the fireground is the result of lack of such support functions and does not generally relate to a breakdown of basic water application activities. Command must cause these support functions to be completed in a timely and effective manner--he/she must support the end of the nozzle. We lose most often because of a lack of support, not a lack of water.

You ventilate a building principally for two reasons:

- To prevent mushrooming
- To gain (and maintain) entry

Vertical ventilation, as close to directly over the fire as possible, is the most effective form of ventilation in working interior fire situations.

The timing of ventilation becomes extremely important and must be coordinated with fire attack activities - ventilation should be provided in advance of attack lines. Portable radio communications between engine and ladder companies facilitate this interaction.

Fire will naturally burn out of holes in roofs, regardless if you cut the hole or if the fire does. If the fire burns through the roof (defensive ventilation), it will generally do so in the best location--directly over the fire. If ladder companies cut the roof they must locate ventilation holes in a manner that will support rescue activities and fire confinement. If vent holes are cut in the wrong places, the fire will naturally be channelled to them and expand loss.

When you cut a hole in a roof, cut a big one.

We ventilate to alter interior conditions. The best operating position to determine if a building requires ventilation and the location and timing of that ventilation is the interior sector. Interior and roof forces must communicate in order to coordinate the effort effectively.

Do not operate hoselines, particularly ladder pipes, down ventilation holes. Be cautious of hoselines to the roof--"candle moth" syndrome tends to overpower personnel operating on roofs when fire and smoke come out vent holes. Operate roof lines only for the purpose of protecting personnel and external exposures unless Command orders a coordinated roof attack.

Effective topside ventilation will tend to keep roofs intact longer and roof conditions become extremely important to ventilation activities. If ladder crews cannot get on the roof to ventilate because of fire conditions/roof profile, Command should consider this a marginal situation. Hose line crews can probably get inside and stay inside longer than ladder crews can stay on the roof. Axiom: It is better to abandon the building a bit too soon rather than a bit too late.

**PHOENIX REGIONAL
STANDARD OPERATING PROCEDURES**

SUPPORT ACTIVITIES

M.P. 202.09

10/99-R

Page 2 of 2

BOWSTRING TRUSS/ARCHED ROOF POLICY

For bowstring/arched roofs the policy is:

1. When fire is in the attic/truss space, and it is safe to do so, quickly search the building and implement a defensive strategy.
2. When crews are unable to locate the fire, and it is safe to do so, quickly search the building and implement a defensive strategy.
3. When fire involves a room and contents with no evidence of extension to the attic/truss space—implement a quick, aggressive, offensive strategy.

RESIDENTIAL TILE ROOF POLICY

For interior and/or attic fires in single family residences with tiled roofs fire fighters are prohibited from going to the roof. Any other structure with lightweight truss construction requires a careful evaluation of fire conditions/roof profile prior to committing personnel to the roof.

Forcible entry involves a trade-off in time versus damage; the faster you force--the more damage you do. The more critical the fire, the less important forcible entry damage becomes and vice versa. If the fire is progressing and you must go in and attack from the unburned side, don't waste time trying to pick the locks--bash the doors.

The provision of access many times will determine if the fire is cut off and extinguished or not. These access-oriented activities generally involve pulling ceilings, opening up concealed spaces and voids, and the activities required to get fire attack efforts in to operate on hidden fire. Such operations beat up the fire building and must be done in a timely, well-placed manner. In such cases, do not hesitate--if you size up fire working inside a concealed space, get ahead of it, open up and cut it off.

Beware of the premature opening of doors, holes, access efforts, etc. before lines are placed and crews are ready to go inside. Good timing requires effective communication between engine and ladder companies.

**PHOENIX REGIONAL
STANDARD OPERATING PROCEDURES**

Attack Teams

M.P. 202.10

11/14-R

12/19-SR

The purpose of this procedure is to give all firefighters an understanding of the Attack Team concept.

POLICY

Command should consider the value of deploying fire engine and ladder companies to build attack teams in the incident command organization.

OPERATIONAL INFORMATION

In many tactical situations it is desirable to group companies together in Sectors to achieve more effective results. This focuses the efforts of the companies toward tactical objectives and provides for a more manageable incident. The Attack Team is an extension of this concept in which companies are assigned on the fireground in groups to work toward a specific objective within a specific area. An Attack Team is an effective operational group for many fireground tasks and provides a sound basis for the creation of sectors which may be built upon as the incident progresses.

A standard Attack Team consists of two engine companies plus a ladder company. The basic grouping of two engine companies and one ladder provides for adequate water supply and support capability to perform strong tactical operations. A common deployment for an Attack Team involves a "forward" pumper supplied by one or two lines from a "key" pumper on a hydrant. In most cases these "Teams" will be created by assigning individual companies and adding resources as they become available. In other situations Command may be able to assign a full Attack Team directly from Staging. The Attack Team will either report to an existing Sector Officer or will become an additional Sector.

During the initial stages of an incident, Command should identify tactical requirements and consider assigning Attack Teams to Sectors. An Attack Team assigned to establish a Sector should be able to perform as an effective unit. Command should designate which officer will assume Sector responsibilities.

**PHOENIX REGIONAL
STANDARD OPERATING PROCEDURES**

HIGH-RISE PLANS

M.P. 202.11 12/20 Page 1 of 12

PURPOSE

The purpose of this document is to identify key strategic and tactical objectives for Phoenix Regional operations in High-rise buildings. These include initial and ongoing building size-up, appropriate use of the risk management profile, assessment of occupant location and removal, and effective sectorization within the incident structure. In the Phoenix Region, a high-rise building is defined as 6 elevator stops or greater or 75 feet in height or higher.

It is important to understand that fighting a fire in a high-rise building is a complex operation that must be based on a solid foundation of incident command and pre-fire attack support sectors. A standard approach to fires in high-rise buildings will enhance our ability for a successful operation. The omission of critical steps in the beginning of an incident can delay suppression operations and risk the lives of firefighters and civilians within the building.

Additionally, we can expect that a working high-rise fire will necessitate the deployment of over 100 firefighters. No Fire Department within the automatic-aid system will be capable of fighting a high-rise fire alone. Key to our shared operational success and safety is a commitment to the principles identified within this SOP. This SOP is not intended to address all potential emergency incidents or fire scenarios that could occur in a high-rise building. This SOP is intended to make sure all automatic aid partners are operating on the same page. The content of this regional SOP is based on case history from historical fires as well as best practices identified.

HIGH-RISE BUILDING SIZE-UP

Exterior View:

- Smoke and fire is often hidden from the exterior due to the building being well sealed and the large area for smoke to accumulate inside the building
- Determine if the building is residential or commercial
- Estimate the potential for falling debris and/or major structural collapse
- Guide responding companies around these hazards

Interior View:

- Building personnel accounts
- Is the building being evacuated?
- Alarm indications
- Stairwell identification
 - Number of stairwells?
 - Conditions within?
 - Standpipe location(s)?

**PHOENIX REGIONAL
STANDARD OPERATING PROCEDURES**

HIGH-RISE PLANS

M.P. 202.11 12/20 Page 2 of 12

- Roof access?
- How are they labeled?
- Have the elevators been recalled?
- What resources are responding?
 - Are additional alarms needed based on observations?
 - Consider a minimum 3rd alarm assignment in working high-rise fires

RISK MANAGEMENT ASSESSMENT

- Is the building occupied?
- Commercial or Residential?
- Time of day and day of week?
- What caused this incident?
 - Accidental fire
 - Intentional
 - Unknown?
- How has this affected building integrity?
 - Is the building going to allow fire and/or rescue operations?
 - Will FD inaction cause the building to collapse into other buildings?
- Fire location?
 - What floor?

TACTICAL OBJECTIVES

Rescue:

- Secure and maintain viable evacuation and fire attack stairwells
- Elevators will not be used as a means of rescue in smoke or fire conditions
- Each of the following will be declared to Command or AHQ prior to making way to the fire floor:
 - Evacuation stairwell = stairwell dedicated to the removal of occupants from the building
 - Fire attack stairwell = stairwell dedicated to the fire attack operations with standpipe connections and roof access. *stairwells with standpipe connections without roof access that are closest to the fire may be preferable, but require special attention to ventilation techniques
- Attempt to diminish smoke conditions
 - Assess and control HVAC systems to eliminate smoke & fire spread
 - Any action that may change smoke or fire conditions should be coordinated with Command
 - Identify stair access to roof

**PHOENIX REGIONAL
STANDARD OPERATING PROCEDURES**

HIGH-RISE PLANS

M.P. 202.11 12/20 Page 3 of 12

- Rescue of immediately threatened occupants
 - Use internal PA systems to direct occupants
 - Protect in place?
 - Remove to safe location?
 - Removal from the building?
- Establish evacuation plan for the remainder of building
 - Remove fire from the victims or victims from the fire?
 - Remove/guide occupants to lower floors or out of the building all together
 - Is protection in place a safe option?

Fire Attack:

- Assess fire and smoke conditions
 - Size of the fire
 - Resources in position to make an attack
 - Overall elapsed time for set up prior to fire attack
- Provide water supply via standpipe system
 - Built in fire pump or pumped by apparatus?
- Stop the production of heat and smoke
- Manage the spread of heat and smoke throughout the building
- Use of building systems includes but is not limited to:
 - Sprinklers
 - Standpipes
 - Fire pump
 - Secure HVAC
- Use of FD equipment includes but is not limited to:
 - PFD vent truck
 - Utility truck to support air standpipe systems
 - Battery/electric fans carried on apparatus
 - Natural ventilation

Property Conservation:

- Often involves high value occupancies
- Extensive damage is not usually contained to one floor alone

DEPLOYMENT

First arriving Fire Department Engine or Ladder Company:

- Assume Command
- Enter the building and locate the Fire Control Room or the fire alarm panel
- Meet with the building engineer (if available)

**PHOENIX REGIONAL
STANDARD OPERATING PROCEDURES**

HIGH-RISE PLANS

M.P. 202.11 12/20 Page 4 of 12

- Establish Building Systems Sector with a minimum of 1 member from the initial Company, and preferably a full company. If a single member is managing Building Systems, a full crew will be assigned to assist the member as soon as practical.
- Accountability passports from the first arriving companies will be left with Systems Sector until Lobby Sector is established
- FD Rescues should not take command if arriving first

Second arriving Engine:

- Report on scene
- Secure a water supply and spot apparatus as close to FDC as possible
- Establish water connection to FDC(s)
- Engineer should remain with the pumper
- Captain and remaining crew will proceed to the Fire Control Room or alarm panel to meet with the initial Incident Commander for assignment, keys, and phone when these resources are available
- Accountability passport will be left with Building Systems Sector until Lobby Sector is established
- If assigned to Stair Team, ensure stairwells are assessed and that the fire attack and evacuation stairwell(s) is identified and announced

First arriving Ladder Company:

- Spot in a position to utilize aerial device for rescue, water supply, or defensive firefight if necessary
- Brings 2 ½ high-rise packs with smooth bore nozzle
- Captain and crew will proceed to the Fire Control Room or fire alarm panel to meet with Command for assignment, keys, and phone

All additional operational resources:

- After a declaration of a “working fire,” once on scene, **all 1st and 2nd Alarm companies should proceed directly to the building and report to Lobby Sector to decrease transit time once an assignment is made.**
- Initial communications between the Incident Commander and Lobby Sector may take place on the tactical channel

Lobby Sector will be operating on the Staging radio channel once Command has transitioned to the Command Van as per the standard Phoenix Regional staging procedures. Lobby Sector, Staging Sector, and Command will coordinate arriving companies for accountability until assigned to a tactical position in the building.

**PHOENIX REGIONAL
STANDARD OPERATING PROCEDURES**

HIGH-RISE PLANS

M.P. 202.11

12/20

Page 5 of 12

SECTORIZATION & SECTOR PRIORITIES

To assure the effectiveness, safety, and accountability of fire companies, all sectors should be managed by *full, intact crews. Building Systems may initially be manned with a single person but will be given a full crew as soon as practical. **Command will not assign single members to manage sectors to rush suppression efforts on the fire floor.**

Building Systems:

- *Due to the amount of initial activities and communications, a full crew should be dedicated to the fire control room from the beginning of the operation. If a single member is left to establish Building Systems a full company will be assigned to assume the sector as soon as practical.
- Companies assigned to lead a sector should be directed by the initial Incident Commander to report to Building Systems for assignment, phone, and keys
- Manage distribution of building keys, fire phones, and floor maps
- Manage internal building systems (ventilation systems, elevators, door lock controls, etc.) and communications
- Coordinate closely with the building engineer (if the building engineer must leave the FC room, a firefighter with a radio will accompany them)
- Provide direct communications (via radio or red fire phones) to stair teams and fire attack companies regarding alarm and building information
- Coordinate communications regarding effectiveness of ventilation systems between stair teams, Ventilation Sector, and Fire Floor Sector

Fire Floor:

- Minimum of three companies
- Will establish “on-deck” staging area for companies in a “clean” environment (preferably 2 floors below the actual fire floor to allow the floor directly below the fire to be used to lay out attack lines)
- Announce the on-deck location to command
- All fire floor operations will be initiated from the on-deck floor.
- Assures attack line, backup attack line and stairwell protection line are in place and the roof access door is in the closed position and stair team is out of the stairwell in a safe location prior to making entry onto the fire floor.
- As the attack team makes entry to the fire floor, command will announce “all units hold all non-emergency radio traffic” to allow the attack team to make an initial assessment and report to command.
- Manage company work cycles in stairwells and on fire floors

**PHOENIX REGIONAL
STANDARD OPERATING PROCEDURES**

HIGH-RISE PLANS

M.P. 202.11

12/20

Page 6 of 12

- Communicate with all sectors and command to establish effective support for fire attack
- The BC/FIT will assume the fire floor sector from the on-deck floor.
- The BC/FIT assigned to the fire floor will deliver the RIC bag to the on-deck location
- Companies will recycle to/from the on-deck location
- Phoenix BC9 should be considered to manage the Fire Floor Sector when possible

Lobby:

- Lobby Sector involves many different tasks and can be initially very labor intensive. Two crews may need to be dedicated early on to properly establish lobby operations and communications.
- Create lobby staging area for crews
- Locate freight and/or Fire Service Access Elevator (FSAE) and determine if it is safe to use
 - If safe to use, assign crew members for proper roof escape hatch preparation of the car, and a dedicated operator
 - Elevators will not be used if smoke or water conditions exist in the elevator hoist way
- Works directly with Command and level 2 staging on the staging radio channel to direct fire companies in Lobby Sector to tactical assignments
- **All companies on first 2 alarms should proceed directly to Lobby.**
 - This allows rapid deployment to sectors from within the building
- In a working fire, maintain a minimum of a 1st alarm of companies in the lobby at all times
- Crew accountability must be tracked based on the assignment
 - All crews ultimately should be tracked by Command
- Manage lobby level elevator access
- Assist with safe egress of evacuating occupants
- Work with law enforcement to prevent re-entry of evacuated occupants

Ventilation:

- Manages communications with Stairwell teams (Fire Attack Stairwell team/Evacuation Stairwell Team) and coordinates with building systems
- Stairwell Teams will precede fire attack companies to identify the fire location, clear the stairwells of occupants, and manage roof access
- Coordinates built in ventilation/pressurization systems and roof access to maintain a habitable environment, and smoke removal as needed.
- Manage FD ventilation equipment and effectiveness
- Communicate with Fire Floor and Building Systems regarding effectiveness of ventilation systems

**PHOENIX REGIONAL
STANDARD OPERATING PROCEDURES**

HIGH-RISE PLANS

M.P. 202.11 12/20 Page 7 of 12

Resource:

- Establish equipment pool in building
- Needs to be well below the “on-deck” floor
 - Decreases the likelihood of becoming contaminated with smoke

Treatment/Transportation:

- May be remote from building
- Triage is key
- Large volume of resources may be needed

Rescue:

- Manage removal of trapped victims or patients from the building

Battalion Chief assignment priorities:

(Depends on conditions and actions in the building)

- Building Systems
- Fire Floor
- Lobby
- Ventilation
- Occupant Services
- Resource
- Treatment (if required)
- Transportation (if required)
- Rescue (if required)

Considerations:

- Incident may quickly become larger than sectors can support
- Identify trigger points that should automatically lead to expansion of the incident organization
- Branches that may be needed:
 - Fire
 - Medical

PD Law Enforcement Liaison

- Coordinate all law enforcement functions within our operations
- C958/TLO

RESCUE PROFILE

- Most severely threatened
- Largest number

**PHOENIX REGIONAL
STANDARD OPERATING PROCEDURES**

HIGH-RISE PLANS

M.P. 202.11 12/20 Page 8 of 12

- Escape routes or methods of removal
- Protect in place
- Use of law enforcement in Lobby Sector
- Each building is directed by fire code to have an evacuation plan including a meeting place outside, away from the building

TREATMENT NEEDS

- Location of treatment area
 - Away from building and fire operations
- Resources needed for treatment and extrication if required
- Utilize law enforcement to secure corridor

FIRE ATTACK

- Crew accountability
- Stairwell teams
 - Immediate deployment to stairwell
 - Provide C.A.N. report from stairwell
 - Assist in establishing operational/tactical priorities
 - Access roof and control access door
 - Closed for fire attack
 - Open for coordinated ventilation operations
 - Rescue or redirect immediately endangered occupants
 - Not involved in fire attack
- Use of elevators
 - Typically, not initially used if fire floor is 10 or less
 - Evaluate the elevator hoist way to determine if conditions exist that prohibit elevator use (smoke, water, sensor indications, blind shaft)
 - Freight elevators are preferable because they are usually larger and service every floor
 - FSAE are best when available as they are well equipped for fire operations
 - Elevator must be Phase II capable (manual operation inside car with key)
 - Elevators must be prepped for use under fire conditions
 - Roof hatch opened
 - Appropriate tools present including telescoping ladder
 - Dedicated FF as an operator
- Hose line deployment
- Small diameter hand lines
 - Fire attack 1 ¾ or 2 ½ (offensive type activity)
 - Back up line with 2 ½ with smooth bore nozzle
 - Stairwell protection with 2 ½ with smooth bore nozzle

**PHOENIX REGIONAL
STANDARD OPERATING PROCEDURES**

HIGH-RISE PLANS

M.P. 202.11 12/20 Page 9 of 12

- Larger diameter hand line or master streams
 - Prevent fire extension floor to floor (defensive type activity)
- Coordination of support activities
 - Building system ventilation and pressurization
 - FD equipment ventilation (vent truck)
 - Utility Truck for support of built in Air Standpipe System (if equipped)
 - Provide air cart to “on-deck” location for Fire Floor Sector
- Crew staging and logistical supply
 - Air
 - Extra bottles
 - Air cart/Utility trucks
 - Manpower

UNIQUE HIGH-RISE SAFETY CONSIDERATIONS

- The standard BC/FIT Sector/Safety Officer will operate in key tactical positions
 - Provide for management of communications, accountability, air management, and work cycles in a standard manner
- All operations in high-rise buildings must be tied to areas of safe refuge
 - Clean environment for changing SCBA bottles
- Air Management
 - All crews entering building must bring a minimum of 1 spare SCBA bottle
 - 1 spare per crewmember initially
 - Due to nature of the building, firefighters can't just step outside to change their SCBA bottle
 - When using stairs to ascend, crews must collectively check their air supply every 5 floors, managed by the Captain
 - Areas of “clean” atmosphere must be identified for retreat
 - These conditions may change rapidly
- Atmospheric monitoring may be necessary
 - CO monitoring in stairwells
 - Invisible dangerous gases
- Stack effect
 - Unique atmospheric conditions during summer and winter months affecting smoke movement inside the building
- Building security systems
 - Electronic locking mechanisms in stairwells and on floors
 - Possibly trapping occupants or firefighters
- Fire on first floor, in lobby, or below grade (sub-sectors)
 - Cuts off the natural escape routes for occupants
 - Inhibits the use of Fire Control Room and building systems

**PHOENIX REGIONAL
STANDARD OPERATING PROCEDURES**

HIGH-RISE PLANS

M.P. 202.11

12/20

Page 10 of 12

- Fire attack may need to come right off Engine companies on the street level

SPECIALTY CONSIDERATIONS

Communication

- Fire Department testing has indicated that the most difficult areas to communicate to and from will be fire control room, stairwells, and elevators
- The initial I.C. must be able to clearly communicate with incoming companies. A position close to the fire control room is preferred. Ascending the stairwell is not a good location for the I.C. due to potential communication limitations
- Use of portable high-rise radios carried on BC9 in fire control room and fire floor sector
- Haz Mat
- TRT
- Air operations
 - Recon
 - Victim removal
 - Deliver firefighters to roof with equipment

INITIAL OPERATIONAL SECTOR SETUP

The model below assumes readily available resources and is meant to be a template for working high-rise firefighting operations in a high-rise building. It provides the initial I.C. a simple plan to establish the required sectors that will maximize safety, communications, and effectiveness. Having the listed sectors in place with coordinated communications should precede the fire attack. The I.C. must assure the tactical decisions made will ensure the safety of building occupants and firefighters.

First Company (engine or ladder):

- Gives an on-scene report of exterior conditions (further report will follow once information is gained from the alarm panel)
- Establishes Command
- Proceeds with crew to the Fire Control Room
- Captain remains the initial I.C.
- Remaining personnel on company manages **Systems Sector** duties in the Fire Control room
- Early balance and additional alarms. Working Fires require a minimum of a 3rd alarm.
- 1st and 2nd alarm companies will come directly to the building

*Due to the amount of initial activities and communications, a full crew should be dedicated to the fire control room from the beginning of the operation. If a single member is left to establish Building Systems a full company will be assigned to assume the sector as soon as practical.

**PHOENIX REGIONAL
STANDARD OPERATING PROCEDURES**

HIGH-RISE PLANS

M.P. 202.11

12/20

Page 11 of 12

Next Engine:

- Connect to the FDC of the building and leave the engineer
- Meets with the I.C. in the Fire Control Room for fire phone and keys
- Assigned by command to identify the attack stairwell closest to the fire with standpipe and preferably roof access, and assume **Stair Team** (designation will be whatever the building designation is i.e. stairwell A = Stair Team A)
- Stair Team will:
 - Only take air bottles, irons, and a PW can (no hose lines)
 - Quickly evaluate each floor for conditions
 - Redirect evacuees to the evacuation stairwell
 - May need to coordinate with Systems to make a PA announcement to building occupants
 - If smoke conditions are encountered during ascent, coordinate with Systems Sector for smoke removal
 - Identify the fire floor location and announce to command
 - If the fire is minor (trash can or kitchen appliance) and can be reasonably be controlled by a PW can, extinguish the fire.
 - Assure the sprinkler isolation valve is in the "OPEN" position
 - Proceed to the roof access door
 - Control roof door as needed
 - Stage in a safe location out of the stairway during the fire attack

Next Company (3rd):

- Assigned the Attack Team leader (4th and 5th arriving companies will be assigned to the Attack Team)
- Brings air bottles, irons, standpipe bag, and high-rise packs
- Meets with the I.C. in the Fire Control Room for fire phone and keys
- Coordinates with the 4th and 5th in companies on ascent
- Assures one 1 ¾ or 2 ½ hose line and two 2 ½ hose lines (backup and stairwell protection) are being carried up
- Assembles the team and stages near the stairwell until the Stair Team verifies the fire floor location
- Communicates the on-deck floor location to Command (two floors below the fire floor)
- Assumes floor # Sector (Sector 15, if the fire is on floor 15)
- Assures the sprinkler isolation valve is in the "OPEN" position
- Makes hose line hook ups in the stairwell and the floor below the fire (if available). Initial 1 ¾ or 2 ½ attack line, 2 ½ back up line, and 2 ½ stairwell protection line from a lower standpipe connection
- Coordinates with Stair Team to assure the roof door is closed and team is out of the stairwell prior to making entrance to the fire floor

**PHOENIX REGIONAL
STANDARD OPERATING PROCEDURES**

HIGH-RISE PLANS

M.P. 202.11

12/20

Page 12 of 12

- Communicates with the I.C. that the Attack Team is ready to make the attack and the roof door is closed, with the Stair Team is out of the stairwell.
- Communicates a CAN report to Command ASAP

Next Company (4th):

- Assigned to be part of the Attack Team
- Brings air bottles, irons, standpipe bag, and high-rise packs
- Meets with the Attack Team leader and the I.C. near the Fire Control Room

Next Company (5th):

- Assigned to be part of the Attack Team
- Brings air bottles, irons, standpipe bag, and high-rise packs
- Meets with the Attack Team leader and the I.C. near the Fire Control Room

Next Company (6th):

- Assigned to be Lobby Sector
- Meets with I.C. in the Fire Control Room for fire phone, keys and accountability passports of all previously assigned companies
- Manages accountability for companies assigned within the building
- Assesses the elevator(s) hoist way for signs of smoke, fire, or water
- If the elevators will be used, an additional company will be assigned to Lobby to provide elevator preparation and a dedicated car operator
- Maintain a First Alarm of available companies in the lobby
- Once the Command Vehicle is set up and the I.C. has transitioned, the primary communication between Lobby and Command will be on the staging channel

Next Company (7th) (unless required to reinforce initial sectors):

- Assign to **Evacuation Stair Team**. Stair team (designation will be whatever the building designation is i.e. stairwell A = Stair Team A)
- Stair Team will:
 - Only take air bottles, irons, and a PW can (no hose lines)
 - Quickly evaluates stairwell conditions
 - If smoke conditions are encountered during ascent, coordinate with Systems Sector for smoke removal
 - Assists evacuees with egress
 - May need to coordinate with Systems to make a PA announcement to the building

Additional Companies:

- Consider early reinforcement of on-deck companies to the Fire Floor
- Match the commitment of initial companies with on-deck companies
- On-deck companies will provide RIC capabilities
- Floor above fire floor

**PHOENIX REGIONAL
STANDARD OPERATING PROCEDURES**

LOSS CONTROL

M.P. 202.12

04/95-R

Page 1 of 5

PURPOSE

The purpose of this procedure is to describe the process to reduce, and in many cases eliminate, certain losses experienced during and following fires and other types of incidents.

INTRODUCTION

There is "value added" to the quality of service when firefighting includes loss control functions. Loss control involves methods of minimizing loss in each of the tactical priorities through all phases of firefighting. Throughout each of the three (3) tactical priorities, the safety and survival of firefighters, customer service, and loss control functions are continuously addressed.

Search & Rescue = All clear
Fire Control = Fire under control
Property Conservation = Loss stopped

This procedure will discuss the elements of loss control and how they are integrated at emergency incidents.

LOSS CONTROL

The loss experienced by the owners/occupants of a structure as a result of a fire is devastating. Primary and secondary loss can be minimized through active loss control efforts. There are many opportunities for effective loss control during property conservation, but the other two tactical priorities (rescue and fire control) present significant loss control opportunities.

In addition to the psychological and emotional injuries our customers may suffer, the building suffers the effects of fire including charring, water, smoke, structural, and content damage. The structure becomes weakened by the fire. The building is unsecured and open to the elements of nature, as well as open to looting. The ceiling and walls throughout the house are damaged by smoke. Furniture receives water and smoke damage. Appliances (refrigerator) and swimming pools are without the electricity they need to preserve food and clean the pool. Through effective loss control efforts we can intervene in all aspects of the incident and take specific measures to minimize loss.

An important element of loss control is to extinguish the fire. Fighting the fire from the unburned portion will effect loss control. This needs to be regularly reinforced with members. Fire attacks from the burning portion will usually push heat and smoke through the building and increase loss.

Performing skills like forcible entry and ventilation should be done with loss control in mind.

Loss control may operate as a sector or a branch. When assigned as a branch, loss control may include several sectors.

PHOENIX REGIONAL
STANDARD OPERATING PROCEDURES

LOSS CONTROL

M.P. 202.12

04/95-R

Page 2 of 5

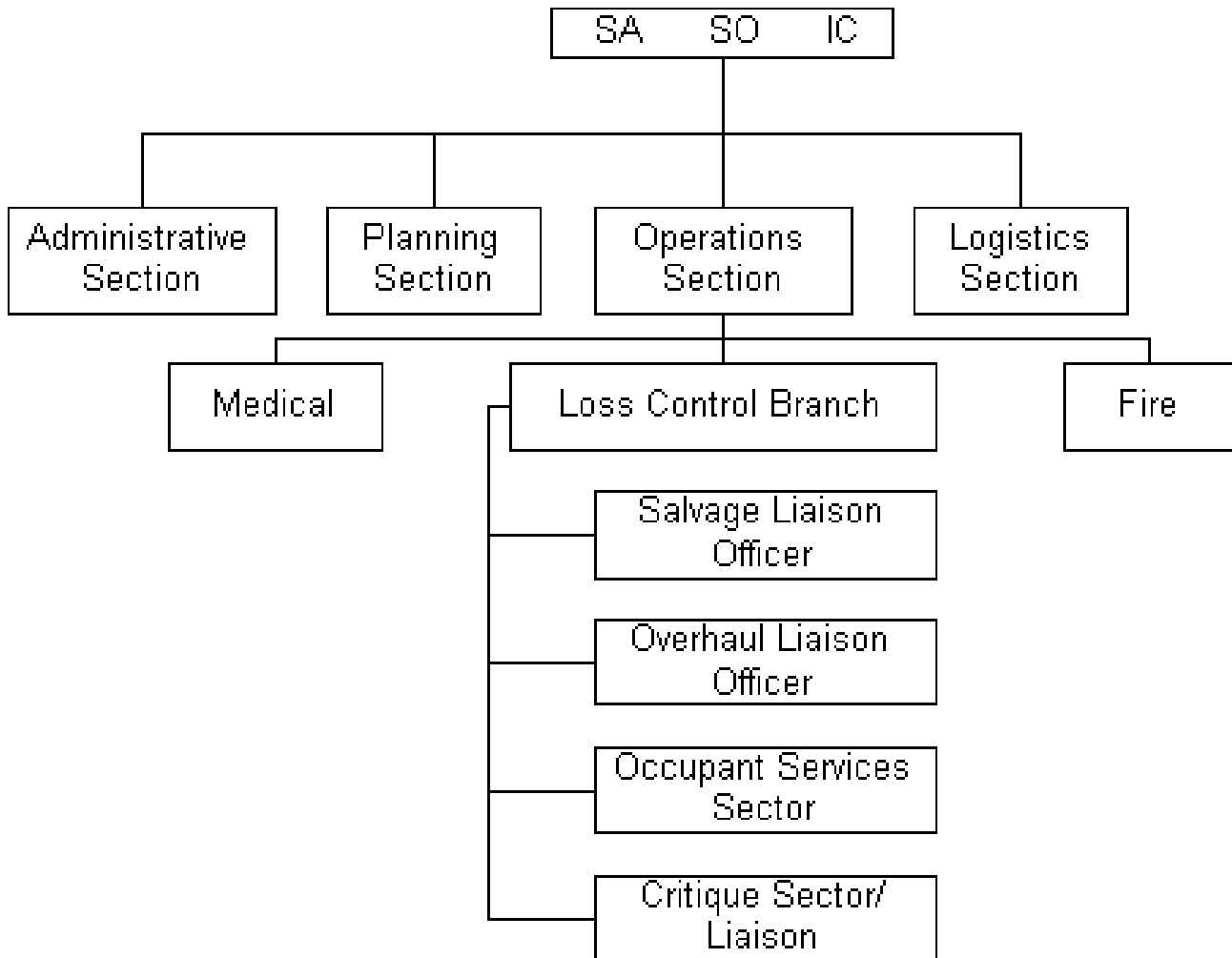

WATER DAMAGE

The most significant thing we can do to reduce damage is to put the fire out. As the fire travels so does the damage. An aggressive interior attack may be the best step towards enhancing loss control efforts. Yet knowing that water will do significant damage to dry wall, furniture, and carpeting, means we have to control how much water is used. If possible, adjust the nozzle to allow for appropriate gallonage as required in attack lines. Do not wet down the attic unnecessarily -- put the water directly on the fire and burning embers. The use of class A foam in firefighting is another method of reducing water damage.

Water acts as a corrosive to pressed gypsum board (dry wall). It breaks the bond used in making the board. Most of the houses and commercial structures we encounter will have gypsum board on the walls and ceilings. When water is left to sit on gypsum board it will seep in and ruin the board. Company officers and firefighters should be aware of the damage to drywall by direct water spray and over spray. Reduce and eliminate over spray and it will minimize loss and water build up on the

**PHOENIX REGIONAL
STANDARD OPERATING PROCEDURES**

LOSS CONTROL

M.P. 202.12

04/95-R

Page 3 of 5

furniture. Standing water on wooden counter tops is also very damaging because it can cause delamination, staining, and cracking. For loss control purposes, wipe off counter tops and table tops with a dry towel not allowing water to sit and penetrate the surface. Furniture sitting in puddles of water will be damaged. Water will migrate up the wooden legs of furniture or over stuffed material and cause it to soak, crack, and stain. Place blocks under legs of the furniture to raise it up and out of the water. If no blocks are available, canned goods from the home serve the same purpose and are an option. Cover exposed furniture and other materials with salvage covers or plastic.

When water has filled the attic space and is pooling on the gypsum use a drill or a screwdriver as a hole punch to allow the water to escape. Water sitting on the gypsum board will eventually seep through; by drilling a small hole we can possibly save the ceiling and the hole is easily patched.

CARPETING/FLOOR COVERINGS

Water on carpeting in itself is damaging. It is made worse by soot and broken glass being ground in when stepping on the carpet. Hall runners should be used to avoid staining and grinding in soot.

When a window is broken to make entry the glass on the carpet may cause the need for replacement, especially if the glass is ground in. When possible throw a carry-all over the glass under the window to prevent the grinding by foot steps. If debris is covering a relatively good carpet or flooring, it should be shoveled out and swept off.

SMOKE DAMAGE

Unless interrupted, the hot smoke produced by fire will move throughout the structure. Positive pressure ventilation (PPV) to clear the smoke is performed during active fire stages. After fire control, closing or opening doors in the structure will help reduce smoke damage during ongoing ventilation efforts.

Cutting a hole in the roof is also favorable. Rapid removal of smoke improves firefighters ability to conduct search and rescue operations as well as effective fire control and salvage operations. Once the fire is extinguished and the embers cooled it is necessary to exhaust smoke. Avoid blowing it throughout the structure and continue to ventilate during overhaul. Take smoldering materials such as a couch outside for overhaul.

When appropriate, turn off the ventilation system in the building. The AC system will expose the remainder of the structure and might contaminate the air handling system (which could require its replacement).

DRYWALL

Work to protect the structure. If possible, when checking for extension by pulling ceiling, do not pull drywall from corners -- it may require that both walls and ceiling be replaced and cause additional loss. Cut small inspection holes, preferably 6" x 6," to check attics. Remember that to relieve excess water in the attic space and to reduce loss, drill drainage holes into the ceiling.

**PHOENIX REGIONAL
STANDARD OPERATING PROCEDURES**

LOSS CONTROL

M.P. 202.12

04/95-R

Page 4 of 5

BUILDING PACKAGING

Just as we package a patient for transport in EMS we should also package a house or structure when we're finished. Each room should be completely ventilated. This will reduce smoke damage. The furniture should be covered with plastic. Water on counter tops and wooden furniture should be wiped off. The furniture should be raised up (blocked) to prevent water damage. Excess debris should be cleared off the floor. It will make the rooms look much cleaner and help alleviate the traumatic impact of the fire for our customers. Debris should be brought outside, kept away from the entrance, be covered with plastic, and anchored.

Customer valuables such as photo albums, video and audio tapes, clothing and other keepsakes found in closets need to be carefully wrapped and placed in boxes. Contents of the box should be marked on the outside for easier retrieval. Do not bag or box wet items. They will need time to dry before packaging.

Access holes where ceilings were pulled, roofs, or walls that were opened should be "squared up" on structural members except where special hazards are present (i.e., asbestos, etc.).

"Securing" the fire scene is also a function of loss control. Securing refers to actions required to protect the structures and contents from damage or looting after fire companies have departed from the scene. Roof ventilation holes and broken windows should be covered with plastic or other materials to reduce weather damage and deter vandalism. The rolled plastic is ideal for this use. For safety reasons, remaining glass shreds should be removed from the frames of broken windows prior to installing covers and always prior to leaving the scene.

ADDITIONAL CUSTOMER SERVICE ELEMENTS

Performing loss control is a mark toward excellence in service delivery. It is a "signature" of professionalism in our craft. We should continually try to add quality and value to our work. In some cases, where safe to do so, escorting the customer through the fire area can help him/her see and visualize what we did and the need for overhaul operations. Also, proper loss control measures should be completed prior to any walk through. Act like the place is yours and the people who own and occupy it are your loved ones...This usually will lead us in the right direction.

In many cases, wearing dirty turnouts into a home on EMS or service calls can soil the furnishings. By keeping our turnouts clean, we could avoid unnecessary damage to flooring, walls or furniture. Simply hose off boots and pants after each fire call to eliminate or minimize loss created by dirty turnouts. This will also help to keep them decontaminated.

Loss control measures may have to be suspended due to fire investigation needs. In this case, fire companies may have to return after the fire investigation to complete loss control activities.

Companies should select an appropriate location for outside piles of debris. Debris in high travel areas should be avoided. Minimize trauma to the customer by helping to make the scene appear less devastating.

**PHOENIX REGIONAL
STANDARD OPERATING PROCEDURES**

LOSS CONTROL

M.P. 202.12

04/95-R

Page 5 of 5

Part of the customer service effort is managing our conduct and behavior appropriately. We should be on our best behavior when working on the emergency scene.

The pets we encounter are, often times, considered by the owners a part of the family. While our primary mission is for the protection and care of people, we should attempt to provide an appropriate level of care and respect to animals in distress. Whenever feasible and safe to do so and as part of our commitment to customer service, we should display an open, caring concern for pets and animals when dealing with a full range of situations.

On larger incidents loss control will be a significant part of the operation and additional resources/alarms may be necessary to insure the effectiveness of loss control efforts.

Loss control efforts will increase the value our customers place on our work. There is no question that we should strive to improve our services. Loss control is an area where we can always improve.

PHOENIX REGIONAL STANDARD OPERATING PROCEDURES	
Policy Name: SALVAGE	Policy Number: M.P. 202.12A
This policy is for internal use only and is not intended, nor should it be construed to expand the legal duty under the law or expand civil liability in any way. This policy does not create a higher duty of care under the law to act. Remedies for violations of this policy, if proven, are limited to administrative disciplinary action against PFD employees.	
Related Policies: 202.01, 202.04, 202.05, 202.05B, 206.02	
Other Reference:	
Date Implemented: 08/2022-R	Review Date: 08/2028

PURPOSE

This procedure describes guidelines for conducting salvage operations. Virtually every fire, small or large, produces a need for some form of salvage operations. Salvage includes activities required to stop direct and indirect fire damage as well as those actions to reasonably mitigate the effects of firefighting operations. This includes losses from water, smoke, and other firefighting efforts. Salvage operations should be aimed at controlling loss by reasonable expedient means.

Salvage objectives are:

- To reasonably stop or reduce the sources of damage
- To reasonably protect or remove contents

Command will provide for salvage at all fires or other incidents posing potential damage to property.

Salvage operations most often involve early smoke removal and covering building contents with salvage covers or plastic. In some cases, the contents of all threatened areas can be removed to a safe location. When removal is not practical, contents should be grouped in the center of rooms, raised off of the floor and covered to provide maximum practical protection.

The following items should be considered when addressing salvage:

- Type, value and location of contents
- The extent and location of the fire
- Recognition of existing and potential damage sources
- Estimate of required resource

EXTENT AND LOCATION OF FIRE

Salvage efforts should begin in areas most severely threatened by damage. In most cases that will be areas directly adjacent to or below the fire area. Additional salvage activities can expand outward until all areas of potential loss are secured.

RECOGNITION OF EXISTING AND POTENTIAL DAMAGE SOURCES

All firefighting activities have the potential to damage property and contents. The key to successful salvage is to distinguish between excessive damage, and damage that is required to reduce potential fire damage. Reasonable loss control activities should be balanced to reduce the potential damage incurred during firefighting activities.

TYPE, VALUE AND LOCATION OF CONTENTS

Replacement price and value should be the primary considerations when performing salvage operations. It is often difficult to separate value from price. Salvage crews should consider both the worth (value) of items and dollar cost. For example, business records, may have extremely high value to business owners while their actual price represents only the paper they are printed on. Pictures, wall paintings, family mementos, etc., may have very high personal value to the property owner.

ESTIMATE OF REQUIRED RESOURCE

An early request for manpower and salvage equipment can significantly reduce loss. The first company assigned to salvage should consider the size-up factors and request sufficient resources to stabilize the situation.

SALVAGE EQUIPMENT

Common salvage equipment includes salvage covers and boxes, rolled plastic, hall runners, brooms and squeegees.

CUSTOMER SERVICE

Command and/or the Sector Officer should meet with the property owner or responsible party when available to determine/identify the salvage priorities. The earlier this can be done, the greater the opportunity to identify high value/priority items or areas. In some cases, when safe to do so, allowing the property owner/occupant to be escorted through the building by Fire Department personnel can be of great assistance to the loss control operation.

PHOENIX REGIONAL STANDARD OPERATING PROCEDURES	
Policy Name: OVERHAUL	Policy Number: M.P. 202.12B
This policy is for internal use only and is not intended, nor should it be construed to expand the legal duty under the law or expand civil liability in any way. This policy does not create a higher duty of care under the law to act. Remedies for violations of this policy, if proven, are limited to administrative disciplinary action against PFD employees.	
Related Policies: 202.01, 202.04, 202.05, 202.05B, 206.02	
Other Reference:	
Date Implemented: 08/2022-R	Review Date: 08/2028

PURPOSE

This procedure establishes guidelines for conducting overhaul operations. While it is impossible to completely eliminate the chances of secondary fires, the goal of overhaul is to reduce the incidence of secondary fires, control loss, and stabilize the incident scene while providing for firefighter safety, preserve evidence, and secure the fire scene.

DEFINITIONS

Cellulose Insulation: Finely ground, recycled newspaper with a chemical additive to increase fire resistance. Cellulose insulation is typically mechanically blown into an empty space of a structure to provide insulation.

Overhaul: A fire-fighting term involving the search for hidden fires and other indicators of fire, and the assessment of final extinguishment after the main body of fire has been knocked down. The goal of Overhaul is to make reasonable efforts to reduce the possibility of a subsequent fire caused by the return to flaming combustion of the original fire or by any other ignition source.

Rekindle: A subsequent fire in a building, structure, pile of debris, or other, where a recent fire was previously extinguished.

Note: Even when reasonable efforts are performed, overhaul may not eliminate all the risks of rekindle; however, it will reduce the possibility. A rekindle is not always and should not be considered *per se* evidence of a return to flaming combustion of the original fire.

Effective overhaul activities help reduce the potential for secondary fires. When addressing overhaul operations, the Incident Commander (IC) should make reasonable efforts to:

- Ensure overhaul is conducted safely. This includes, but is not limited to, following the SOPs for Fireground Exposure Reduction (206.02) and Self-Contained Breathing Apparatus (202.05B).
- Ensure allied equipment (Thermal Imaging Camera, foam applicator, etc.) are utilized when necessary.
- Use early and continuing positive pressure ventilation to maintain an acceptable working environment and reduce loss. Fire companies must evaluate and monitor conditions when operating fans.
- Meet with the property owner/occupant concerning overhaul operations.
- Schedule fire companies to conduct post-incident drive-by/walk-through of fire building to check for potential re-ignition sources.
- Coordinate overhaul with fire investigators.

CUSTOMER RELATIONS

In the absence of an occupant services sector, the IC, or the company officer should meet with the property owner/occupant to explain the reasons for overhaul operations. Where it is reasonably safe to do so, the IC, or the company officer, may escort the property owner/occupant through the fire area to explain the need for overhaul operations. Proper loss control/salvage operations should be completed prior to any walk-through. Providing the property owner/occupant the opportunity to remove personal possessions/valuables or assisting them in boxing and removing these items is excellent customer service and a loss control opportunity.

Reasonable efforts should also be made to assist the property owner/occupant in notifying insurance agents of the fire.

HIDDEN FIRES

Reasonable fire suppression operations might not detect and extinguish small pockets of fire concealed in construction voids or hidden under debris. Overhaul activities include searching the fire scene to detect and extinguish hidden fires or "hot spots." Suppression crews should open as many of these construction voids as reasonably possible. Floor, wall or ceiling areas showing evidence of extensive decomposition due to fire should be thoroughly examined during overhaul. Additional areas to check include wooden door jambs, air conditioning vents and registers, baseboards, door and window casings, metal to wood connections, ties, straps, conduits, and areas around light fixtures and electrical outlets. TICs, foam applicators, axes, pike poles, and Halligan tools are most commonly used for this purpose. Although a TIC may not be able to detect small hot spots, it can nonetheless be a valuable tool when looking for hidden fire/hot spots. Foam application during overhaul cannot guarantee complete suppression of all materials.

Attic fires can pose a special hazard for secondary fires where insulation has been exposed to fire. Large areas can receive fire damage and can be located in difficult to reach areas. In some cases, insulation should be reasonably removed to extinguish all remnants of fire. It is understood that

there is no possible way for firefighters to completely remove all insulation (especially cellulose insulation). Removing insulation in many cases means removal of large sections of ceiling. If possible, a reasonable risk/benefit discussion should be conducted with the owner/occupant to discuss the extent of insulation removal. The department cannot be held responsible for secondary fires if owner/occupants understand the risks associated with limited insulation removal. Plenum spaces, soffits and pipe chases should receive careful inspection as they provide possible routes for fire to spread throughout a structure. Some construction features do not allow this.

The IC is responsible for ensuring that the fire area has been reasonably overhauled. The company officer last leaving the scene is responsible for fire extinguishment, when possible. The IC is further responsible for scheduling post-incident drive-by/walk-through inspections of the fire building when needed. Post-incident inspections include a walkthrough of the building or areas when safe to enter. Crews should search for evidence of smoke or remaining hot spots. Crews should examine materials below salvage covers. In some cases, crews may need to create additional openings in the structure. A post incident inspection will be performed prior to the last fire department unit leaving the scene. The IC is responsible for assessing the need for additional post incident inspections and coordinating the plan with Dispatch & Deployment. A reasonable period of post-incident inspections may be scheduled to prevent secondary fires in buildings that contain cellulose insulation. The IC may waive post incident inspections if a fire watch is in place. If The IC believes the circumstances warrant a fire watch, C99 should be dispatched to the incident. C99 will meet with the building owner/occupant so that the owner/occupant understands Fire Code requirements including fire watch qualifications and cost, and to ensure that the owner/occupant complies with the Fire Code.

CELLULOSE INSULATION FIRES

Cellulose insulation, which is one of the most commonly used insulation types, has been used in structures for several years. When exposed to heat, sparks or flames, cellulose insulation presents special problems for the fire service, businesses, and building owners/occupants. Hot spots can get buried deep inside cellulose insulation where they can lie before breaking into fire. Fire companies at structure fires that have cellulose insulation should:

- Follow standard operating procedures for obtaining all clear and fire control.
- Identify cellulose insulation as soon as possible.
- Evaluate the use of fans based on the presence of cellulose insulation.
- Follow standard overhaul procedures contained in this M.P.
- While it is widely recognized that it is impossible to remove all cellulose insulation and impossible to absolutely prevent all secondary fires or rekindles of a structure, fire companies should remove or wet down as much insulation as reasonably possible.
- Have utility companies pull the electrical meter and ensure other utilities are secured.
- Meet with the owner/occupant and the fire investigator to advise the owner/occupant that they should not occupy the structure.

DEFENSIVE FIRES

Overhaul activities as described above will not be conducted on structures that have been declared Defensive Fires. Firefighter safety prohibits standard overhaul activities in structurally compromised buildings. Crews will continue to apply water to hidden fire/hot spots from exterior positions until all fire is completely extinguished. During campaign operations, the IC will coordinate the rotation of crews through Dispatch & Deployment.

EVIDENCE PRESERVATION

Companies performing overhaul should compare the importance of preserving evidence to the danger of immediately removing debris and extinguishing all traces of fire. In some cases, it may be necessary to monitor spot fires until investigators arrive on the scene. In these instances, and when possible, evidence should remain untouched, undisturbed and in its original location. Where circumstances prohibit this, evidence should be removed under the direction of a fire investigator.

SECURING THE FIRE SCENE

Securing the fire scene is also a function of overhaul. Securing refers to actions required to protect the structure and contents from further loss after fire suppression companies have left the scene. Roof ventilation holes and broken windows should be covered to reduce weather damage and deter vandalism. Rolled plastic is ideal for this purpose. For safety reasons, reasonable efforts should be made to remove remaining glass shards from the frames of broken windows prior to installing covers or leaving the scene.

Securing the scene also includes the actions required to address the safety of all persons likely to visit the incident scene. Once a hazard zone is established during firefighting operations, it must not be abandoned prior to removing or stabilizing the hazard. Overhaul companies should provide means of identifying and guarding hazards that cannot be removed or stabilized. Reasonable efforts, including, but not limited to barricades, hazard tape, and the posting of guards are all methods depending upon severity.

**PHOENIX REGIONAL
STANDARD OPERATING PROCEDURES**

OCCUPANT SERVICES SECTOR

M.P. 202.12C

05/95-R

Page 1 of 2

The purpose of this procedure is to establish the role and responsibilities of the Occupant Services Sector.

The Occupant Services Sector shall be established by the Incident Commander at all working structure fires, and as early in the incident as is practical. The Occupant Services Sector should also be established at any incident where the need is identified; Fire, EMS, Special Operations, etc.

The Occupant Sector is a critical extension of our service delivery, and serves as the liaison between the Fire Department and those citizens (responsible parties) directly, or perhaps indirectly involved in or affected by the incident.

If necessary, Command will request additional resource in order to establish the Occupant Services Sector. An additional engine, ladder, or battalion chief is acceptable. If necessary, at prolonged incidents, in order to return fire companies and personnel to service, Command may assign staff personnel to this function. The Occupant Services Sector responsibilities may extend beyond the termination of the incident.

RESPONSIBILITIES:

The Occupant Services Sector should consider offering the following services to the occupant/responsible parties. It should be noted that other occupant service needs may be identified and should be addressed as part of the Department's customer service goals.

- Carry out responsibilities under supervision of loss control officer.
- Explain what happened, what we are doing and why, how long we expect to take until the incident is under control.
- Obtain from occupant/responsible party, any significant information regarding the structure and/or its contents that might assist Command tactically with the operation. Inform Command of this information.
- Provide cellular telephone access.
- Communicate the location to which evacuees have been sent. (Notify the Investigations Sector of this location also when passing on this information.)
- Identify any mental health needs of occupants/responsible party's, as well as any spectators or evacuees. (i.e., affects of shootings, mass casualty, highly visible critical rescue, etc).
- Notify Red Cross, Salvation Army, or other relief agencies.
- Notify other necessary agencies and/or individuals.
- Provide coordination of salvage efforts with the loss control officer.
- Where safe to do so, and after approval from Investigations Sector, coordinate a "Walk-through" of the structure with the responsible party.
- Determine the location of valuables in the structure and notify Command/Loss Control officer.
- Work with loss control and proper utility services to restore power, gas and water, as quickly as possible to reduce additional losses through a loss of business to affected occupants.

**PHOENIX REGIONAL
STANDARD OPERATING PROCEDURES**

OCCUPANT SERVICES SECTOR

M.P. 202.12C

05/95-R

Page 2 of 2

Provide use of service vans as necessary.

- Coordinate site security.
 - Fire watch
 - Private security company
 - Necessary insurance services
 - Any services identified as necessary and possible

- Handout and explain the "After the Fire" brochure.
- Assist the occupant in notifying insurance agents, security services, restoration company, etc.
- Provide blankets, and a shelter, where practical to do so, (i.e. an apparatus cab, neighbor's house, etc.) To get occupants out of the weather and at a single location.
- Provide on-going service and support until the customer indicates our services are no longer needed.

The Occupant Services Sector shall report to Command unless a loss control Branch/Section is assigned, at which time he/she shall report to the loss control officer.

MENTAL HEALTH NEEDS

Occasionally, the public is witness to a critical life threatening event that can have substantial psychological impacts on them. These persons may be survivors of a critical event or a witness to a mass casualty, or a parent of a severely injured child, or a witness to the death of a family member, etc.

Additionally, witnesses may have misunderstandings of fire department operations that cause a delay in removal of the patient (i.e. trench collapse, an electrocution rescue that is delayed due to energized contact, etc.). Addressing these issues early, on-site, or as soon as possible following the event, can minimize these misunderstandings, and reduce psychological effects, and produce improved relations with the public.

The Occupant Services Sector should consider additional help for these needs. Assistance and advice on availability of mental health services can be obtained through the department's Critical Incident Debriefing Team, the Employee Assistance Program Contractor, the American Red Cross, and in some cases, through the victim's personal medical insurance. Support from the Fire Department Chaplain or local clergy may also be available.

AMERICAN RED CROSS SERVICES

For residential fires where the occupant has suffered a loss of living quarters and clothing, the American Red Cross may be used to provide support.

The American Red Cross can provide some clothing, food, toiletries, and arrange for temporary shelter/housing for the occupants. When contacting the Red Cross, provide the following information:

- Address of the incident.
- Address where victims can be contacted.
- Phone number of contact location.
- Number of displaced persons with information on age, sex, etc.
- Fire Department Incident No.

M.P. 202.12D Positive Pressure Ventilation

This SOP is currently out for review.

PHOENIX REGIONAL STANDARD OPERATING PROCEDURES	
Policy Name: WATER SUPPLY AND FIRE STREAM MANAGEMENT	Policy Number: M.P. 202.12E
This policy is for internal use only and does not expand an employee's legal duty or civil liability in any way. This policy should not be construed as creating a duty to act or a higher duty of care, with respect to third party civil claims against employees or the Phoenix Fire Department (PFD). Remedies for violations of this policy, if proven, are limited to administrative disciplinary action against PFD employees.	
Related Policies: 201.01, 201.01C, 201.06, 202.02C 202.04, 202.05	
Other Reference: UL Fire Safety Research Institute (FSRI), NFPA 1700	
Date Implemented: 03/2022-R	Review Date: 03/2026

PURPOSE

To provide guidelines for determining water supply needs and selecting the most effective hose line size or sizes based upon initial and ongoing size-up and fire ground factors.

OVERVIEW

Adequate water supply during fire attack operations has a critical impact on fire control outcomes. Water on the fire as quickly as possible improves the tenability of potential victims and improves conditions for firefighters to operate. An uninterrupted water supply is necessary to sustain effective water volumes during a fire attack in all critical tactical positions. An ineffective fire attack with inadequate water volume leads to delayed fire control, increased risk to firefighters and victims, and greater fire loss.

HYDRANT WATER SUPPLY

First due engine companies approaching the scene with any evidence of a working fire should secure a water supply. Exceptions to this guideline may include:

- Known or highly suspected rescue requiring a full crew
- Unsure of actual fire location in multi-unit residential or commercial building complex
- Fire in a high-rise building

Hillside or remote custom homes, junkyards, re-cycle or mulch facilities, high fire-load occupancies, and limited hydrants require pre-planning for unique hose-lays, drafting from canals, or extremely long supply lines.

Adequate water supply lines must be considered to all tactical positions that fire companies are working from. This includes interior or exterior fire attacks from hose lines and/or master streams. The number of supply lines and configuration of forward and key pumpers in any tactical position

will be determined by the water supply needs established by the incident action plan. This can be accomplished through “big water” evolutions, tandem pumping, and/or relay pumping operations. These will be determined by hydrant/water supply availability and the distances between the water supply and position of the fire attack.

Supply lines must be laid with consideration for access problems they create. When possible, lay the supply hose along the hydrant-side of the roadway and cross over at the fire if necessary. Slow down when laying lines, faster speeds result in excess hose on the roadway. Slower speeds also provide several advantages:

- Reduces the risk of striking pedestrians or vehicles or firefighters.
- Provides time for the Company Officer to size-up and evaluate critical fire ground factors.
- Provides time for the Engineer to appropriately spot the apparatus.

PUMPED WATER

After initial arriving companies have established an adequate water supply, subsequent arriving companies should stage in a manner to be easily assigned as a key pumper in critical tactical positions. Providing key pumpers on hydrants enhances fire ground safety in several ways:

- Ensures an uninterrupted water supply
- Provides volume when needed for extremely long supply lines (e.g., apartment’s, re-cycling facilities or areas with limited water mains & hydrants)
- Ability to pump water through the forward pumper in the event of mechanical failure

Pumped water supply (Humat Valve Operation) is critical when large volumes of water are required in any tactical position. This provides for adequate water volume in attack operations including engine company mounted master streams, ladder pipes, or multiple high volume (2” and/or 2.5”) attack lines are in operation.

Generally, first alarm companies should lay their own supply lines when establishing any tactical position before pumped water is considered/needed. In most cases, an unsupported forward supply lay of 500 feet of 4” supply line can flow 800 GPM. Most initial attack operations, including engine mounted master stream operations can be adequately supplied without pumped water for initial fire attack operations.

In most cases, the need for pumped water occurs once initial fire attack operations have been established. Command and/or Sector Officers should address the need for pumped water as ladder pipes or multiple Engine Mounted Master Streams are ordered into operation.

MASTER STREAM SUPPLY LINES

When establishing supply lines for master stream operations it is necessary to provide standard “big water” hose evolutions to provide adequate water volumes for ladder companies. Aerial apparatus typically can flow 1000 gpm per deck gun. Most aerial platforms have 2 deck guns

(capable of 1000 gpm per deck gun). Aerial platforms or aerial ladders should be considered 1000 plus gpm appliances.

Standard “big water” evolutions include a forward and key pumper, 2 supply lines between the forward and key pumper, and pumped water by the key pumper supplying the 2 supply lines. The forward pumper must be positioned as close to the ladder company as possible to diminish the length of supply line from the forward pumper to the ladder company inlets. The “big water” evolution can be conducted in a few different manner’s dependent on available apparatus. The most efficient manner includes the forward pumper completing a forward lay from the hydrant to the ladder company. The key pumper then completes a reverse lay from the forward pumper to the hydrant with a second supply line.

ATTACK HOSE LINE CHOICE

The objective of the attack hose line choice is to provide enough water volume and reach to overcome the heat energy and heat release rate of the fire or an adequate flow to effectively cool and protect exposures.

BASIC ATTACK HOSE LINE PLACEMENT

When operating in the offensive strategy, fire attack hose lines of adequate water volume should be used to put water on the fire and/or onto burning compartment surfaces as quickly as possible. They should also be used to control access to hallways, stairways, or other vertical and horizontal channels through which people and fire travel.

- The first water stream should be placed to extinguish and/or cool the most endangered interior compartments from the most advantageous position (interior or exterior) to best impact tenability of victims and/or firefighters conducting rescue efforts.
- When no victims are present, the water stream should be placed on the fire with adequate volumes to attempt to suppress the fire and attempt to limit the spread to exposures.
- When immediate exposures are present, water streams should be directed on the exposures as early as possible.
- Back up hose lines should be deployed to protect a means of egress when necessary (always bear in mind the presence of Fire personnel operating in opposing positions).
- Back up lines should be of the same or greater water volumes when possible.

When a change from offensive to defensive operation occurs, crews should pull hand lines out of the fire building only if safe to do so. Do not delay exiting the building for the sake of salvaging a few feet of hose and a nozzle if conditions are deteriorating rapidly unless the line is needed for crew protection during egress operations.

FIRE STREAM CHARACTERISTICS AND CONSIDERATIONS

Fire companies must consider the characteristics of fire streams and choose the most effective nozzle and stream for the volume of fire and the size of the fire compartment(s).

Solid or straight stream:

- Greater penetration
- Greater reach
- Greater striking power
- Greater cooling of interior surfaces
- Greater cooling of exposed spaces
- Less steam conversion

Fog pattern (narrow, medium, wide)

- Shorter reach
- Smaller water droplets
- Greater air entrainment
- Greater steam production
- Most effective in confined spaces such as attics

The current hose and nozzle packages that are carried on Phoenix Fire Engine Companies include:

- 1 ¾" hose line with automatic nozzles (x2 minimum)
 - Hose lengths include:
 - 150' crosslay
 - 200' crosslay
 - 100' to 150' front bumper line
- Automatic nozzle (75 psi nozzle pressure for 70 to 200 GPM)
 - 2" hoseline with smooth bore nozzles (x1)
 - Hose length:
 - 200' crosslay or rear mount depending on apparatus configuration
 - Smooth bore nozzles with 1 1/16" tip (260 GPM at 60 psi nozzle pressure)
- 2 ½" hose line with smooth bore nozzles (1 or 2 depending on apparatus configuration)
 - Hose length:
 - 200' rear mount (1 or 2 depending on apparatus configuration)
 - Smooth bore nozzle with 1 3/16" tip (265 GPM at 40 psi nozzle pressure)
 - Blitz Monitor with solid bore or peripheral tips (up to 500 GPM)

FIRE STREAM CONSIDERATIONS – OFFENSIVE STRATEGY

An offensive fire attack should be centered on knocking the fire down and cooling the interior spaces to improve tenability for victims and improve working conditions of searching firefighters. When an initial attack does not control the fire completely, some considerations must be made. It must be determined if the fire simply requires more water to overcome the heat energy and/or does the fire attack additionally need to come from alternate position(s) (either interior or exterior)?

Through fire behavior research it has been clearly identified that fire is most effectively extinguished by water on the interior surfaces of a burning compartment, room, or space to cool the interior temperatures initially and then water on to the burning fuels directly. This is most effectively done with a straight or solid bore stream to keep the water droplets from the hose stream as large as possible. This limits the potential for steam production and creates cooling of the interior environment that tends to contract the hot gases. This is most effective in smaller residential spaces that allow for better water application on the interior surfaces from the most advantageous position. The same principals are true for commercial occupancies however due to size and complexity; it becomes significantly more difficult.

For fires that begin on the exterior of a building or occupancy, the fire attack should begin on the exterior fire and move to the interior. If an interior attack is initiated without controlling the exterior fire, the interior fire will continue to be fed from that exterior fire. A simultaneous fire attack on the exterior and interior spaces is the most effective means when possible.

Early identification of the direction of a flow path at a structure fire allows Firefighters to determine the best method of fire attack to work within the intake portion of the flow path, rather than against it. This may not always be possible and when the only option for Firefighters is to make a fire attack from the exhaust portion of the flow path, extreme caution must be taken. Considerations for changing the ventilation profile may change the direction of the flow path and create favorable conditions to begin a fire attack. It's critical that any changes that impact the ventilation profile are well coordinated.

UL-FSRI Fire Flows from High Pressure to Low Pressure

<https://www.youtube.com/watch?v=O8s3Q57TZtE>

UL-FSRI Flow Path and Suppression Must Be Considered Together

https://www.youtube.com/watch?v=B7k7_F2lowg

When wind conditions are present, it is safest to initiate the fire attack with the wind at the back of Firefighters. When wind driven conditions are present during an interior fire attack, extreme caution must be taken to control the ventilation intake, if on the windward side. Uncontrolled ventilation intake during wind driven conditions has created deadly conditions for Firefighters across the country. It must be identified and avoided.

UL-FSRI Keep the Wind at Your Back

<https://www.youtube.com/watch?v=G3hF14iNec8>

Backing up an initial fire attack is an important consideration. Backing up an initial attack must be conducted with hose streams/water volumes that match or exceed the initial hose line.

Beware of hose lines that have been operated in the same place for long periods. Fire conditions change during the course of fire operations (most things will only burn for a limited time) and the effect of hose line operations must be continually evaluated. If the operation of such lines becomes ineffective, move, adjust, or redeploy them.

Beware of the limitations of operating nozzles through small openings in to confined spaces such as attic spaces, truss lofts, cocklofts, or mansard style roof. The mobility of such streams is limited, and it is generally difficult to get water on the interior surfaces. Fire streams from above a confined space makes it very difficult to get water on the underside and structural components for the most effective surface cooling. Sometimes buildings or conditions will require fire companies to breach walls/floors to apply water to a burning space. It is important to realize the potential limitations.

Basement fires are most effectively extinguished when the water is applied from the same level as the fire. Basements with man-door access allow for the most effective water application on the interior surfaces from as steep an angle as possible, in the same manner as any other interior space. Basements with no exterior access or partial access from ground level windows creates a challenge for water application. Water must be applied from the most advantageous exterior position, through the windows (when possible) to cool the interior environment to allow interior access. If no exterior access is possible, extreme caution must be exercised as the only access to the lower level/basement will be through the flow path (chimney) from the floor above. All possible actions must be exercised to attempt to cool the interior environment prior to making access.

UL-FSRI - Initiate Your Firefight on the Same Level as the Fire

<https://www.youtube.com/watch?v=OVQFRzpVr9Y>

UL-FSRI - Basement Fires: don't get caught in the flow path exhaust

<https://www.youtube.com/watch?v=3YiLLsWuOxg>

Company Officers and Sector Officers must assume responsibility for the effectiveness of their fire streams. These officers must maintain an awareness of where fire streams are going, their effectiveness, and then report the general operational characteristics back to the Sector Officer or Command. Company Officers must understand and be competent with the nozzle characteristics and features of the operating nozzles to get the most effective volume and stream while operating on the fireground.

FIRE STREAM CONSIDERATIONS – DEFENSIVE STRATEGY

When master streams are needed for large volumes of water to slow fire growth, extinguishment, or to protect exposures, they must be used with deliberate understanding of their strengths and challenges. Master streams should be used for large volumes of fire or to protect exposures that require large volumes of water to do so. They can certainly provide up to 1000+ gpm. That can

provide significant surface cooling however that comes with powerful striking force and significant water weight (1000 gpm = 8,340 pounds of water per minute and 139 pounds of water per second). This can have adverse effects on structural stability immediately and over time.

Exterior master streams should not be used with interior operations in the same structure or occupancy depending on the building type. The exception to this would be a defensive strategy while protecting exposures from interior positions at structure fires where these tactics are applicable from the perspective of risk management. It is possible to flow master streams in the fire occupancy while working with handlines from interior positions to protect exposures in other occupancies after a thorough size up and determination of structural stability. Command and Sector Officers must closely coordinate any exterior master streams with interior operations or personnel operating nearby.

Master streams may be useful in knocking down a large body of fire in a segment of a structure where the intent is to operate in offensive positions after significant knockdown is achieved. Command and the Sector Officers must evaluate the structure's stability in these situations. This evaluation should occur after the master streams are shut down and BEFORE committing crews to interior positions. When there is any question as to the stability of the structure crews should not be deployed to interior positions.

When there is a change in strategy from Offensive to Defensive, Command must prioritize hand line operations. Large volume hand lines such as 2.5" and 2" lines may be used to protect exposures from defensive positions outside of the hazard zone. Smaller (1 ¾") hand lines should be shut down after changing to a defensive operation. Pump operators should close the discharges to these lines to prevent well-meaning firefighters from trying to use hand lines where they are ineffective and allow Firefighters to creep into the hazard zone. Command and sector officers must maintain all members in positions outside the collapse zone and prevent firefighters from moving into unsafe positions.

**PHOENIX REGIONAL
STANDARD OPERATING PROCEDURES**

HANDLING PETS AND OTHER ANIMALS

M.P. 202.12F 05/95-R Page 1 of 3

OBJECTIVE

The objective of this procedure is to provide field personnel with guidance in handling pets and other animals that are encountered as a result of an EMS, fire or other response. These pets or animals may require medical attention and the RP is unknown or unable to care for the animal, or the animal presents a danger to the general public. The pets or animals we encounter might also be trapped or injured.

The pets that we encounter are often times considered by the owners a part of the family. While our primary mission is for the protection and care of people, we should attempt to provide some level of care to animals in distress whenever feasible and safe to do so as a part of our commitment to customer service. We should display an open, caring concern for pets and animals when we deal with the public in these types of situations.

SAFETY CONSIDERATIONS

Caution should be used in approaching any animal, especially one that is injured. At no time is the safety of our members or that of the public to be compromised by attempting to capture an animal. If there is any doubt, contact one of the agencies listed in this procedure and request that they respond. When dealing with pet or animal rescues, they should be handled similar to "property" when evaluating the risk/gain profile of the incident.

HANDLING PETS

Rescue Efforts (fires, trapped or injured pets)

Rescuing pets or animals during an incident should take the same priority as any loss control activity. An evaluation should be made in terms of the risk or exposure that our personnel would face, versus the likelihood of a positive outcome.

Treatment of Injuries

Animal injuries can be treated in a similar manner as BLS injuries to a human. For example, bleeding can be controlled by direct pressure, elevation and bandaging. Burns can be cooled with water. Oxygen can be administered for breathing difficulties. Broken limbs can be stabilized using splints. At no time, however, should any attempt be made to provide fluids intravenously.

Caring Attitude/Empathy

We should realize that to many people, an animal or pet is considered a family member. We should attempt to treat their concerns with empathy and demonstrate a caring attitude towards their concern. In addition, if the incident has resulted in the death of an animal, we should attempt to assist them in the disposal of the animal by contacting the proper agency, such as the Humane Society or the ASPCA for guidance.

If there is any question regarding the handling or care of a pet, any of the agencies listed in CAD are more than willing to provide guidance and assistance. They all stated that if they are not able to help, they will put us in touch with the proper agency. A case in point may be in the situation where we have treated and transported a rider who has fallen from a horse--what do we do with the horse? The proper agency in this case is Arizona Livestock, but ASPCA stated that they may be able to provide assistance in securing the animal until further action can be taken.

**PHOENIX REGIONAL
STANDARD OPERATING PROCEDURES**

HANDLING PETS AND OTHER ANIMALS

M.P. 202.12F 05/95-R Page 2 of 3

CONTACT NUMBERS

Whenever there is any question regarding handling an injured, non-injured, stray or trapped animal, both the Humane Society and the AZ Society for the Prevention of Cruelty to Animals are willing to either provide direct assistance, or serve as a clearing house in directing us to the proper agency or veterinary service. Both have 24 hour hotlines listed in CAD. To access this information by MDT, type MDTINFO ANIMALS.

Stray animals

For stray, uninjured animals, the call should be referred to the Maricopa County Animal Control (for the telephone number, see "MDTINFO ANIMALS" in the CAD system).

Injured animals

The two primary agencies that can be contacted to respond to injured animal calls (where the animal is not a threat to human safety) are:

Humane Society
AZ Society for the Prevention of Cruelty to Animals
(both numbers are in CAD under "MDTINFO ANIMALS")

Both agencies have personnel available 24 hours a day and will respond valley-wide when requested. In the event that they are not able to handle the particular animal involved (for example, an exotic animal) they will provide you with the proper agency to contact for assistance.

If it is necessary to move an injured animal out of a roadway, the recommended procedure is to wrap the animal in a blanket and immobilize it before moving it. Muzzling the animal with material such as kling or a PackStrap would be suggested. This will help to minimize the danger to the rescuers.

ANIMAL RESCUE (NON-EMERGENCY)

In the event that you should encounter an animal that is in distress, but is not injured (cat-in-tree type of call, contact the following agencies (the telephone numbers are in CAD under "MDTINFO ANIMALS")):

Humane Society
AZ Society for the Prevention of Cruelty to Animals

If they are unable to provide timely assistance, they will direct you to an agency that can help.

DANGEROUS ANIMALS

When there is a danger to human safety, Animal Control will respond. (Also request that PD respond.) Their telephone number can be accessed on the CAD via "MDTINFO ANIMALS." Responders should take actions to ensure that the safety of the public and Department members is not compromised while waiting for the arrival of Animal Control.

**PHOENIX REGIONAL
STANDARD OPERATING PROCEDURES**

HANDLING PETS AND OTHER ANIMALS

M.P. 202.12F 05/95-R Page 3 of 3

IMMEDIATE ACTIONS TO BE TAKEN IF THE ANIMALS LIFE IS IN DANGER

If an animal is injured to such an extent that its life is in danger, at the discretion of the ranking fire department officer, the animal may be transported to a veterinarian for emergency care.

There is a list of emergency animal clinics listed in the CAD under "MDTINFO ANIMALS." The cost for this treatment will either be passed on to the owner, or if the owner cannot be identified, then ASPCA will pay for the treatment. No cost will be incurred by the Fire Department or a member for bringing in an injured animal encountered as part of a fire or EMS response.

The animal should be transported only to those clinics listed. They are equipped with full emergency care facilities and have agreed to accept animals transported by the Fire Department to their facilities.

It is very important to remember that an injured animal may present a danger to rescuers. At no time should a member's safety be compromised in handling an injured animal. If an animal is considered dangerous, the call should be referred to Maricopa County Animal Control.

OTHER AGENCIES

There are other agencies that can respond and deal with injured animals. They are listed under "MDTINFO ANIMALS" in the CAD system. The first call, however, should be either the Humane Society or ASPCA since they have personnel available 24 hours. If they are not able to handle the problem, they will refer you to the appropriate agency.

**PHOENIX REGIONAL
STANDARD OPERATING PROCEDURES**

FIRE CAUSE INVESTIGATION

M.P. 202.13

02/10 – R

Page 1 of 6

RESPONSIBILITY

The determination of fire origin and cause is necessary for all fire incidents. The Officer in Charge is responsible for determining when a Fire Investigator is needed. This determination is dependent on the information gathered at the scene and/or circumstances of the fire. The on-duty Fire Investigators are available through Dispatch and Deployment or by phone to consult with Command prior to or during response to assist Command.

A fire investigation is conducted after fire control and salvage activities are completed, but before overhaul actions, which could hinder the investigation.

DISPATCH

A Fire Investigator dispatched by Dispatch and Deployment or called by the Officer in Charge, will respond to the scene reference the following circumstances:

- Fire deaths or serious fire injuries
- All working first alarm or greater structure fires
- Fires for which the cause cannot be determined by Command on the scene
- Explosions and bombings
- Requested by Phoenix Police Department to respond to known arson fires
- Car, field, or dumpster fires that have an identified lead or suspect in custody
- Attempted arsons

NON-DISPATCH

A Fire Investigator is not needed for the following situations. The company officer is responsible for completing an accurate Field Incident Report to document the fire cause:

- Minor fires where cause is determined to be accidental
- Scalding burns, electrical accidents, and minor accidental burn injuries
- Car fires originating in the engine area during vehicle operation, abandoned autos, or vehicle arsons with no identified suspects
- Minor grass, fence, or trash fires with no witnesses or suspects
- Traffic accident fatalities involving fire subsequent to collision (investigated by Phoenix Police Department)
- To hold the scene until another agency or service responds
- When requested to make contact with homeowner for the purpose of insurance matters
- Minor fires caused by juveniles playing with fire, matches, etc. These incidents are referred to the Youth Firesetter Program. Referrals are made by completing the Youth Firesetter Referral Form on Firewire in the Links column, clicking PFD Programs and filling out the form or calling the Youth Firesetter Coordinator at 602-262-7757.

**PHOENIX REGIONAL
STANDARD OPERATING PROCEDURES**

FIRE CAUSE INVESTIGATION

M.P. 202.13

02/10 – R

Page 2 of 6

If an incident is determined to be of a minor nature (e.g. accidental, no injuries, slight fire damage) and the cause can be determined by the Company Officer on scene through the information gathered at the scene and/or circumstances of the fire, units on the scene shall gather the information needed and to accurately complete the required report. If a victim requests information regarding their fire loss, the Company Officer can give the Fire Department Incident Number to assist the victim to accessing Fire Department information through the Custodian of Records at 602-256-3395. The victim should also be given a copy of the P.F.D. "After the Fire" brochure to assist them.

FIRE SCENE COORDINATION

When a Fire Investigator is on the scene or responding, companies will delay non-essential overhaul and secure the fire scene until the Fire Investigator arrives. Salvage and all unnecessary interim activities which may alter, contaminate the fire scene, or interfere with a subsequent origin and cause investigation must be discontinued until authorized to continue by the responding Fire Investigator.

Command will assign personnel to protect and maintain custody of the fire scene until the arrival of a Fire Investigator, especially when a delay in response has been indicated by the responding Fire Investigator.

After achieving fire control, Command may release companies not required for the completion of the investigation and/or overhaul. In some cases, involving lengthy investigations, companies may return to quarters and later respond back to the scene to complete overhaul activities when requested by the Fire Investigations Sector.

Command will turn over jurisdiction of the fire area to the Fire Investigator as soon as possible after the fire is stabilized. The Investigator retains jurisdiction of the scene until it is released back to Command. The Fire Investigator may inform Command they need to maintain custody of the scene for further investigation.

The Investigator will request from Command any personnel or equipment necessary for the investigation. Command will make every attempt to meet such requests, to the extent possible under the prevailing circumstances.

All personnel will cooperate with the Fire Investigator and the Fire Investigations Sector. Protection of the fire scene and preservation of physical evidence is a primary concern once life safety and fire control are achieved.

An attempt to identify the victims and witnesses at the fire scene will be made as soon as possible, and will not be delayed until the Fire Investigator is on the scene. Obtaining the identification of victims and witnesses is critical to the investigative process.

**PHOENIX REGIONAL
STANDARD OPERATING PROCEDURES**

FIRE CAUSE INVESTIGATION

M.P. 202.13

02/10 – R

Page 3 of 6

PRESERVATION OF EVIDENCE

Every fire scene contains evidence. Fire fighting operations present the greatest potential for damage to evidence which may be used by the Fire Investigators and the Police Department in subsequent court cases and prosecution.

Evidence of fire cause is rarely destroyed by fire. The form, shape, color, size, and weight of items may be altered, but evidence can still be identified upon trained examination. It is imperative to preserve evidence as found, in place and not moving fire debris unnecessarily.

It is the responsibility of the Fire Department to protect the fire scene from unnecessary damage during fire fighting operations. Special care exercised during extinguishment will avoid the destruction of evidence through the misuse of fire streams. Salvage operations should be minimal until the initial fire investigation is completed, and should be confined to diminishing loss. Companies assigned to Loss Control Sector should incorporate scene security and evidence preservation into their plan to stop the loss.

The fire scene is the Fire Investigator's laboratory. It is searched carefully and thoroughly, photographed, diagrammed for placement of contents and evidence, and evidence is then collected and preserved.

The fire scene must be secured. Evidence cannot be used in court unless the Fire Investigator can establish a chain of custody by proving who found the evidence, where it was found and the evidence was not tampered with while in official custody. To ensure that the chain of custody remains unbroken, the scene must remain in the sole custody of the Fire Department. When at a fire scene where custody must be maintained, a guard must be posted, and custody must be maintained until the scene is released. No unauthorized persons may enter the scene. The Fire Department has the legal authority to close the scene entirely, even to the property owner or to other interested person/s. It is vital that the Fire Department prevent personnel from unnecessarily walking through a fire area, walking on, obscuring evidence, or picking up and moving evidence. This includes both Fire Department personnel and the media. If it is essential that evidence be moved or if necessary fire fighting operations may damage evidence, the evidence must be covered or its location marked before moving it carefully to a secure location.

ACCELERANT DETECTION CANINE

The Phoenix Fire Department Investigations Section has the services of an accelerant detection canine assigned to the unit. The canine is used by the assigned Fire Investigator/Handler to identify the use of accelerants in the ignition of the fire. Personnel should avoid contact with the dog unless given permission by the dog handler.

The canine will be called by the on-duty Fire Investigator, as needed.

**PHOENIX REGIONAL
STANDARD OPERATING PROCEDURES**

FIRE CAUSE INVESTIGATION

M.P. 202.13

02/10 – R

Page 4 of 6

JOINT FIRE/POLICE INVESTIGATIONS

Police Department Responsibilities per PPD Operations Order 4.7, Rev. 11/06

FIRES

- Officers will assist the Fire Department in determining the location, size, type of fire, and any special information, which may help in determining the number of fire units necessary.
- Officers will take appropriate action to rescue victims of fires but, if possible, will notify the Fire Department prior to any rescue attempt.
- Officers' primary responsibility at the fire scene will be to control pedestrian and vehicular traffic as well as to prevent the interference with firefighters or officers at the scene.

NOTE: When persons disobey or interfere with a firefighter at a fire scene, they may be arrested, if necessary, in aggravated cases (Refer to PCC 23-21.1 or ARS 13-2904.5).

- Officers will contact the senior Fire Department supervisor at the scene for specific instructions.
 - When Command indicates a perimeter of the fire is necessary, Command will also indicate which areas are to be protected.
 - Officers will divert traffic, as needed, to limit congestion.
 - Special care will be taken to prevent vehicles from crossing fire hoses.
 - Officers will perform other police-related duties and functions as requested by the Fire Department.
- When off-duty firefighters are required to report to a fire scene, they will be permitted to proceed immediately to the fire scene in their personal vehicles, if necessary, after properly identifying themselves.
- The Police Department will not provide personnel for extended periods of time solely for the purpose of securing property at a fire scene.
 - The Fire Department will be responsible for contacting a private security agency to perform that service.

Police Department Responsibilities per PPD Operations Order 4.7, Rev. 11/06

ARSON INVESTIGATION

- **Initial Investigation**
 - When arson is suspected, officers will secure the scene and request a Fire Department investigator.

**PHOENIX REGIONAL
STANDARD OPERATING PROCEDURES**

FIRE CAUSE INVESTIGATION

M.P. 202.13

02/10 – R

Page 5 of 6

- Fire investigators are certified peace officers with police powers only in arson-related matters.
- Fire investigators are on duty 24 hours a day and may be contacted through Fire Alarm Dispatch at 602-262-7496.
 - Fire investigators have portable radios with access to all precinct channels.
 - Radio codes will not be used when communicating with fire investigators.
- Upon the fire investigator's arrival at the scene, officers will advise them on:
 - Observations of smoke color
 - Flame intensity
 - Security of the property upon first officer's arrival
 - Any personal knowledge of past activity at the premises
- All fire apparatus carry the yellow "FIRE LINE - DO NOT CROSS" tape, available to officers to aid in securing the scene.
- Arson of vehicles will only be investigated by the Fire Investigations Section when a suspect is in custody or immediate investigation is possible.
 - The responding fire company is responsible for relaying all suspect information to the Fire Investigations Section and supplying the victim with necessary information.
 - The Fire Investigations Section will conduct follow-up investigations.
 - Victims' questions will be referred to the Fire Department.
 - An engine company should be called to the scene of vehicle arsons where the fire has been extinguished or has burnt out so that a report can be prepared for the Fire Investigations Section.

Police Department Responsibilities per PPD Operations Order 4.7, Rev. 11/06

Arson and Reckless Burning Reports

- Disposition will be taken by a fire investigator.
 - Fire Investigators are authorized to write arson and reckless burning DRs only.
 - If another crime is involved, such as burglary or stolen/recovered vehicle, officers will investigate the incident and complete an "A" DR.
 - A supplement will be completed to provide any additional pertinent information.
- Officers, who must leave the scene prior to the arrival of the fire investigator, will leave their name, serial number, and work unit telephone number with the officer remaining at the scene or with fire command for later follow-up.

**PHOENIX REGIONAL
STANDARD OPERATING PROCEDURES**

FIRE CAUSE INVESTIGATION

M.P. 202.13

02/10 – R

Page 6 of 6

Police Department Responsibilities per PPD Operations Order 4.7, Rev. 11/06

Arson Evidence

- Fire investigators are responsible for the collection, preservation, and impounding of all arson evidence found at the scene.
- Officers or a Laboratory Services Bureau evidence technician will dust for latent fingerprints when possible.
- The fire investigator will take all necessary photographs, which may include those related to another crime at the arson scene.
- If the crime, other than arson, is of a serious nature, such as homicide, a Laboratory Services Bureau evidence technician should also photograph the scene.

OPEN BURNING

- If neither reckless burning nor arson apply, but a fire was willfully set, the City Fire Code (Ordinance G-2221, Section 28.1a) prohibiting open burning without a permit may be used.
- An open burning permit may be obtained from the Fire Prevention Division of the Fire Department.
 - Officers receiving complaints of open burning will contact the Fire Prevention Office to determine if a permit has been issued.
 - If no permit exists, an engine company will be called to the scene so a report can be prepared for the Fire Investigations Section.
- If the situation appears to be serious, the officer will call a Fire Department investigator to the scene for appropriate enforcement action.

FIRE DEPARTMENT LIAISON

- The administrative lieutenant in the Patrol Support Bureau is the Police Department's liaison with the Fire Department.
- Questions or concerns about the Fire Department's operations should be forwarded in a memorandum to the Patrol Support Bureau's administrative lieutenant.

**PHOENIX REGIONAL
STANDARD OPERATING PROCEDURES**

TRAINING FIRES

M.P. 202.14

10/04-R

Page 1 of 11

PURPOSE

The purpose of this procedure is to establish standard guidelines for conducting structural training fires while complying with NFPA Standard 1403. All other Phoenix Regional procedures will also apply to training fires where applicable.

The objective of a training fire is to provide realistic fire ground training under actual fire conditions for recruit and uniformed firefighters while providing high levels of safety and minimizing risk to firefighters.

Training fires will be designed to minimize the risk and to control the fire conditions so that firefighters are not unnecessarily exposed to hazards or injuries.

Training fires present the same hazards as those encountered at actual field incidents. The Incident Command System employed at actual fire incidents will be Standard Operating Procedure at all structural training fires. Refer to Volume II, Standard Operating Procedures.

PROCEDURES FOR ON OR OFF SITE BURNING

PERMITS

The Training Academy holds a burn permit issued by Maricopa County Environmental Services Department. The officer in charge is responsible for complying with the conditions stated on the burn permit. This includes burning only during the months and hours specified on the permit. Check the burn permit located in the main office to verify that the permit is current and has not expired.

The officer in charge is also responsible for calling the Air Quality Division each morning of the day of burning to obtain permission to burn that day. The phone number is (602) 506-6700. You must fill in the log at the time of the phone call with your name, the person you spoke to, type of burn, and time of day.

Note: Burns conducted outside the City of Phoenix boundaries may require local permits in addition to the county permit. Check with local jurisdiction before burning.

All burns, (off-site and on-site) must be conducted in compliance with the Fire Department's Burn Permit issued by the Maricopa County Department of Environmental Services, Air Quality Division. This includes limitations on the times when burns are allowed and pre-approval of all burns to ensure that they do not contribute to violations of the air quality health standards. Burn permits conducted off the training academy campus MAY require a burn permit specific to site/property where the burn is to occur.

All structural off-site burns require an asbestos survey and filing a completed NESHAPs form with Maricopa County Department of Environmental Services, Air Quality Division at least ten (10) working days prior to the scheduled burn.

**PHOENIX REGIONAL
STANDARD OPERATING PROCEDURES**

TRAINING FIRES

M.P. 202.14

10/04-R

Page 2 of 11

COMMAND

One officer on the scene shall be designated as "Command" and will assume the Command functions.

A Command Post shall be established and positioned to afford maximum visibility of the structure, operating companies and fire conditions.

COMMUNICATIONS

Command is responsible for establishing radio communications with each company officer or training officer involved in the drill. Channel assignment must be coordinated with Dispatch and Deployment and all companies involved. Companies operating at the training fire will continuously monitor the assigned radio channel. All radios will be checked for proper functioning and correct channel prior to initiating training fire operations.

SECTORS

To eliminate confusion, and provide adequate scene control, all personnel operating within the fireground perimeter shall operate under the direction of a sector officer. The fireground perimeter shall be defined as the hazardous area surrounding the burn structure and shall be determined by Command following guidelines stated in Fireground Safety.

The following sectors shall be established on all structural training fires.

- Interior - Company or training officer directing interior suppression activities.
- Exposure - Provide manned, charged hose line positioned to protect exposed property. More than one hose line (and therefore, more than one sector) may be required, depending on the exposures present.
- Rescue - (RIC) Provide a manned, charged back-up line for each fire attack team, in position to assist in fire extinguishment and rescue of interior personnel. This sector will be manned by experienced firefighting personnel (not recruit firefighters) and each Rapid Intervention Crew (RIC) shall consist of a minimum of three firefighters. A company officer shall be in charge of each RIC unit. There shall be one rescue (RIC) team for each fire attack team. The RIC will be positioned in a ready state near the exterior point of entry.
- Rehab - All personnel not assigned to other sectors will be under the direction of Rehab. Rehab area will be established in a location that reduces congestion around the fire building.
- Safety - The Safety Officer (or a safety representative) will be in attendance at all structural training fires and will assume safety sector responsibilities. The safety sector will monitor personnel and fire conditions, and work with Command to ensure all safety procedures are complied with, and that risk to personnel is minimized.

**PHOENIX REGIONAL
STANDARD OPERATING PROCEDURES**

TRAINING FIRES

M.P. 202.14

10/04-R

Page 3 of 11

Other Sectors - Other sectors may be established as necessary to control training/fire control operations and to minimize risk to firefighters.

SAFETY

The Safety Officer shall have full authority to intervene and control or stop any aspect of the operations when in his/her judgment; a potential or real risk to personnel exists. He/she will not be assigned other duties that would distract from his/her safety responsibilities.

Additional Safety Officers may be assigned to the training fire if the conditions dictate. Responsibilities of the Safety Officer(s) will include but not be limited to the prevention of unsafe acts and elimination of unsafe conditions.

Company officers acting as instructors will be responsible for the direct supervision of assigned students and their safety and welfare, including the prevention of unsafe acts and the elimination of unsafe conditions.

Fire Department personnel will not be permitted to operate on the roof during active fire conditions in the building.

The number of personnel involved in training fires often exceeds the number normally assigned at actual incidents. To reduce risk, and assist with scene management, training fire participants shall be formed into individual companies consisting of no more than four (4) members and supervised by a company officer.

Exposing recruit firefighters to structural training fires presents special safety considerations. All sector officers should anticipate that a recruit firefighter's exposure to interior fire conditions may be less than orderly. To reduce the possibility of injury, the span of control for interior operations shall not exceed two recruits for each company or training officer.

All firefighters involved in structural training fires shall have received training to meet the performance objectives of Firefighter I, NFPA 1001 in:

- Forcible Entry
- Protective Breathing Apparatus
- Fire Hose, Nozzles and Appliances
- Fire Streams
- Ladders
- Ventilation
- Rescue
- Safety
- Fire Behavior

No personnel shall be permitted to act as a victim(s) during live training fires.

**PHOENIX REGIONAL
STANDARD OPERATING PROCEDURES**

TRAINING FIRES

M.P. 202.14

10/04-R

Page 4 of 11

To reinforce safety procedures, a protective clothing and equipment inspection shall be conducted on all firefighters immediately prior to and after engaging in suppression activities. The inspection shall insure that all clothing and equipment is serviceable and worn in a manner to provide the maximum personal protection.

The Safety Officer will be responsible for completing the safety checklist prior to initiating the training exercise.

One officer on the scene shall be designated as an accountability officer and will assume the accountability functions.

To enhance accountability and to improve tracking of firefighters in the Hot Zone, the "PASSPORT" system shall be used,

Personnel Accountability Report or "PAR" shall be used at the following accountability benchmarks:

- Upon entering the structure
- Any report of a trapped or missing firefighter
- By all crews reporting an "All Clear"
- At a report of fire under control
- Upon exiting the structure
- Sudden hazardous event
- Change from offensive to defensive strategy
- At the discretion of Command

Passports will remain with the designated accountability officer near the "point of entry" to the Hot Zone. Upon entry, crews will turn in their PASSPORT. Upon exit, the crew must retrieve their PASSPORT. The accountability status board will contain only the PASSPORTS of those crews in the Hot Zone.

Access to the training fire building will be controlled by fire line tape that shall be stretched around the fire-building perimeter.

Personnel within this perimeter may be permitted to operate with the SCBA facepiece removed. All other protective clothing items shall be in place.

All personnel not wearing appropriate protective clothing and equipment shall remain outside the fire line perimeter.

REQUIRED FIRE EQUIPMENT AND COMPANIES

Two separate sources of hydrant water supply shall be established (two Engine Companies minimum). The water supply shall be test flowed by the forward pumper to insure adequate water supply of a minimum of 500 gallons per minute.

**PHOENIX REGIONAL
STANDARD OPERATING PROCEDURES**

TRAINING FIRES

M.P. 202.14

10/04-R

Page 5 of 11

All fire attack hose lines shall be supplied by one pumper. The RIC unit backup hose lines shall be supplied by a second pumper. All hose lines will be flow tested to confirm a minimum of 95 gpm.

An on-duty battalion chief or other chief officer designated by the Training Academy staff shall be on scene to supervise the overall operation.

A utility truck and a rescue shall be on scene prior to the start of the training fire. An ALS company shall also be on scene.

Access to the scene shall be controlled to permit emergency access to and from the site.

All apparatus will be appropriately placed or staged in accordance with the Phoenix Regional Standard Operating Procedures.

STARTING THE FIRE

The use of flammable or combustible liquids, as defined in NFPA-30, shall be prohibited for use in live fire training evolutions. Only Class A materials shall be used in live fire training. The ignition process will be conducted under the direct supervision of the Safety Officer. Command shall assign an experienced firefighter to become "FIRESTARTER." It is the responsibility of the FIRESTARTER to initially ignite the fire. FIRESTARTER shall also regulate the fuel load for each evolution to maintain a tenable atmosphere inside the training fire rooms. The RIC unit shall be in place with a charged hose line prior to ignition.

ATTACK PLAN

The officer in charge shall develop an attack plan based upon information obtained during the pre-plan and building preparation stages.

The Attack Plan shall specify:

- Points of ignition
- Amount of fire load
- Position of entry attack lines
- Position of RIC units
- A Rescue Plan

All personnel involved in the drill shall be instructed on each element of the attack plan prior to igniting the structure and shall receive a walk through briefing of the building prior to each training fire. An evacuation plan and signal shall be reviewed and agreed upon.

RE-USE OF LIVE TRAINING FIRE BUILDING

The building will be re-inspected by the Safety Officer for structural integrity and for any hazards or unsafe conditions prior to each additional training fire in the structure.

**PHOENIX REGIONAL
STANDARD OPERATING PROCEDURES**

TRAINING FIRES

M.P. 202.14

10/04-R

Page 6 of 11

RECORDS AND REPORTS

The following records and reports shall be maintained on all live fire training for two years.

- a. An accounting of the activities conducted.
- b. Roll call of all participants, including the Safety Officer and other support personnel.
- c. Documentation of unusual conditions or events encountered.
- d. Any injuries and treatment provided.
- e. Copy of "Transfer of Authority" form signed by property owner.
- f. Copies of all permits, releases or other documents relating to the training fire.
- g. Records of critiques.

OFF SITE TRAINING BURNS

PRE-PLANNING

The officer in charge of the drill will conduct an initial inspection of the training fire site. If the building appears acceptable, he/she will make an appointment with the Safety Officer to inspect the building.

Single-story structures shall always be considered first choice when selecting training in interior firefighting operations. Two-story structures will only be considered when the building has been thoroughly inspected by the Safety Officer and the Command officer. Both officers must agree that the building is structurally sound for training burns. Adequate egress/access points on the second floor must be readily available.

The officer coordinating the training fire will inspect the building with the Safety Officer. The building must meet fire safety and structural integrity criteria before approval to conduct a training fire is given by the Safety Officer. The Safety Officer shall have full authority to deny approval if the building is determined unsafe. Buildings incapable of withstanding exposure to fire conditions shall not be utilized. Buildings with bars on windows or doors that cannot be removed shall not be utilized.

Traffic control will also be a major factor for consideration in approving live structural training fires. Approval will not be given where traffic cannot be effectively controlled or re-routed.

ASBESTOS CONSIDERATIONS

Prior to scheduling any training activities an asbestos consideration must be conducted by an AHERA accredited asbestos building inspector to ensure that no asbestos is present in the structure. The asbestos survey must follow AHERA guidelines and in addition include sampling of all materials, which are determined by the inspector to be suspect for asbestos. This MAY include roofing components, ceiling tiles and finishes, flooring or interior and exterior textured wall treatment layers including but not limited to stucco and paint. Metals, wood and glass are recognized as having no potential for asbestos.

**PHOENIX REGIONAL
STANDARD OPERATING PROCEDURES**

TRAINING FIRES

M.P. 202.14

10/04-R

Page 7 of 11

If asbestos is determined in any layer of material, in concentrations greater than 1%, the structure/house may not be used for any type of training activities, including burns, forcible entry, etc.

If the building is found to be free of asbestos materials (<1% by layer), a NESHAPs form must be filed with Maricopa County Air Quality Asbestos Unit at least 10 working days before the scheduled burn.

RESTRICTED AREAS

Training fires are not permitted in the following locations:

- The Central Corridor (Seventh Avenue on the West and Seventh Street on the East).
- The Airport Relocation area (24th Street on the East and 14th Street on the West. The freeway on the South and Jackson Street on the North).

Drills that draw opposition from neighbors or other members of the community should be discontinued.

BUILDING PREPARATION OBTAINING PERMISSION AND PERMITS

The training officer coordinating the live structure burn shall be responsible for obtaining all releases, permits and other approvals and releases relating to the training fire. They shall include, but not necessarily be limited to the following:

1. Confirm a clear title on the property.
2. Obtain written permission from the building owner.
3. Verify ownership of the selected building.
4. Obtain documented proof of cancellation of insurance on the selected building.
5. Obtain a burn permit from Urban Services.
6. Obtain permission to burn from Air Quality Control.
7. Obtain approval from immediate supervisor.
8. Obtain approval of Safety Officer.
9. Review requirements and restrictions in the Fire Department's Burn Permit with Maricopa County Department of Environmental Services. Review expiration date on the permit.
10. Request and confirm completion of an asbestos NESHAPS survey to be completed by a AHERA Certified Building Inspector and submit a completed NESHAPS to Maricopa County Air Quality for approval 10 working days prior to a burn day.
11. Request and confirm completion of an inspection by the Fire Department's Industrial Hygienist fro City Safety to evaluate the presence of hazardous waste, mercury, lead, and other regulatory issues.
12. If asbestos, in any form, is determined in the structure, the structure will not be considered for training burn or any other type of training activity.

**PHOENIX REGIONAL
STANDARD OPERATING PROCEDURES**

TRAINING FIRES

M.P. 202.14

10/04-R

Page 8 of 11

SITE PREPARATION

The following preparations will be made prior to conducting a training fire in a structure:

- Request a walk-through of the property by the Fire Department's Industrial Hygienist or a representative Industrial Hygienist from City Safety. The walk through should include a review of asbestos testing results, ad results or inspector for hazardous waste, mercury, lead and other results of previous inspection.
- Confirm that utility service (gas and electric, etc.) has been disconnected.
- All debris will be cleared from entrances and exits and from the immediate exterior area.
- At least two points of egress shall be provided in all training fire structures.
- All interior contents shall be arranged to permit free access to and egress from all rooms.
- No additional combustible, or smoke generating substance other than wood pallets or other Class A materials will be added to any structure.
- The fire load shall be conservative.
- Low-density combustible fiberboard and unconventional interior finishes shall be removed.
- All windows and doors to be used for egress or emergency evacuation will be checked for and made capable of unrestricted opening.
- Structures will be pre-vented at the roof. The roof vent opening may be covered with an appropriate material. A metal cable will be attached to prevent burn-through and the cable will be extended to the ground. The vent cover will be removed at an appropriate time during fire attack operations to permit ventilation and prevent flashover or backdraft.
- Heavy roof, attic, or ceiling equipment or fixtures, etc., shall be removed.
- Pre-training fire checklist shall be completed.

NOTIFICATION OF TRAINING FIRE ACTIVITIES

Prior to conducting structural training fires, the following notification must be made.

- Fire Prevention—Obtain a burn permit from Fire Prevention. A burning permit must be obtained for all training fires conducted off Training Academy grounds.
- Dispatch & Deployment--location, time, type of burn, companies being utilized.
- Obtain permission to burn from Maricopa County Department of Environmental Services Air Quality Control Division.
- On-duty Public Information Officer (PIO)
- Shift Commander
- Battalion chief whose battalion the training fire will be in.
- Safety Officer
- District commander in whose district the training fire is being conducted.
- Occupants of adjoining property
- Police Department
- The office of the Deputy City Manager
- The office of the District Council member

**PHOENIX REGIONAL
STANDARD OPERATING PROCEDURES**

TRAINING FIRES

M.P. 202.14

10/04-R

Page 9 of 11

OFF SITE PRE-TRAINING FIRE CHECKLIST

- Call Maricopa County Department of Environmental Services Air Quality Division for permission to burn on morning of burn day (phone number is listed on permit)
- On-site building inspection by Safety Officer
- Inspection by Fire or City Industrial Hygienist (for asbestos, hazardous waste, mercury, lead, etc.)
- Building structure was analyzed for structural integrity
- Exposures evaluated
- Special Hazards considered
- Access to site and all sides of building adequate
- Water supply from two hydrants/adequate
- Street traffic blockage considered
- Exterior debris, trees, and brush cleared
- Two points of egress/exits available
- Windows/doors unrestricted
- Interior access unobstructed; uncomplicated
- Ceiling fixtures removed
- Class A fuel only for fire starting
- Interior combustibles fire load reasonable/conservative
- Permits/permission and other documentation obtained
- Evidence of prerequisite training (NFPA 1001) obtained for students from outside agencies
- Adjacent property owners notified
- All utilities disconnected
- Heavy attic or roof objects removed
- Porches, steps, or railing made safe
- Notifications made
 1. Maricopa County Department of Environmental Services: permission to burn on morning of burn day (phone number is listed on permit)
 2. Fire Department or Personnel Safety Industrial Hygienist
 3. Request and confirm asbestos NESHAPs form filed 10 working days before the burn
 4. Fire Prevention
 5. Dispatch & Deployment
 6. Public Information Officer
 7. Shift Commander
 8. Battalion chief in training area
 9. Safety Officer
 10. District commander
 11. Police
 12. Air Quality Control
 13. Deputy City Manager
 14. District Council member

Signed: _____

**PHOENIX REGIONAL
STANDARD OPERATING PROCEDURES**

TRAINING FIRES

M.P. 202.14

10/04-R

Page 10 of 11

ON-SITE TRAINING FIRE OPERATIONS CHECKLIST

- Call Maricopa County Department of Environmental Services Air Quality Division for permission to burn on morning of burn day (phone number is listed on permit). Verify that the permit has not expired.
- Class A Fuel only
- Adequate fire apparatus on site
- ALS company on-scene
- Rescue on-scene
- Rehab on-scene
- Utility truck on-scene
- Two separate hydrant water sources secured
- Pumpers flow tested for a minimum 500 gpm water supply
- Roof pre-vented with adequate opening
- Vent covers with cable to ground
- Fire load; conservative; not excessive
- Ignition location determined
- Safe ignition fuel utilized
- Igniter person fully protected with protective clothing/SCBA
- Protective line for igniter person; manned and charged
- Ignition from exterior only
- Chief officer on site as Incident Commander
- Safety Officer (or representative) on-scene
- Command and sectors established
- Command location identified and announced
- All radios checked for proper functioning/channel
- Sectors established
 1. Interior
 2. Exposure(s)
 3. RIC(s)
 4. Rehab
 5. Safety
 6. Other
- Attack lines in place, flow tested for a minimum of 95 gpm each
- RIC unit in place, flow tested for a minimum of 95 gpm each
- RIC unit staffed by minimum of three firefighters
- One backup RIC unit in place (with hose line) for each fire attack entry team
- Attack lines from one pumper, RIC lines from a separate pumper
- Fire attack entry and RIC unit fully "suited up" in protective equipment, PASS unit and SCBA checked for proper functioning
- Company officers in charge of each entry and RIC unit
- Specific plan of operation established, understood by all
- Walk through briefing conducted for all crews
- Rescue plan established, understood by all
- Emergency evacuation plan and signal determined and agreed upon
- Fire Line tapes in place
- Provision for on site sanitary facilities/"Porta Jon," etc.
- Accountability Officer established

Signed: _____

**PHOENIX REGIONAL
STANDARD OPERATING PROCEDURES**

TRAINING FIRES

M.P. 202.14

10/04-R

Page 11 of 11

POST TRAINING FIRE CHECKLIST

- ___ All personnel accounted for
- ___ Equipment and clothing checked for damage
- ___ Remaining fires overhauled/controlled
- ___ Critique conducted
- ___ Total extinguishment completed at end of training operations
- ___ Copy of "Transfer of Authority" form signed by building owner
- ___ Building secured or made safe
- ___ Bunker gear and equipment decontaminated

Signed: _____

**PHOENIX REGIONAL
STANDARD OPERATING PROCEDURES**

TRAINING ACADEMY ON-SITE BURN BUILDING FIRES

M.P. 202.14A 08/96-R Page 1 of 6

PURPOSE

The purpose of this procedure is to establish standard guidelines for conducting on-site training fires in the Training Academy burn building, while complying with NFPA Standard 1403. All other Phoenix Fire procedures will apply to training fires where applicable.

GENERAL USAGE

Any fire department member or outside agency wishing to use the burn building must first obtain permission from a Training Academy chief officer.

The time and date of the training drill must be scheduled with the Training Academy staff. Drills involving recruit training and departmental training always have first priority.

An officer representing the Training Academy staff must be on-site for any live fire drills involving the facilities or the burn building. A fee may be charged to outside services/agencies.

Burn buildings have been designed specifically for the purpose of repeated live fire training evolutions and include safeguards that only become unacceptably hazardous through misuse and neglect.

Training Academy burn building shall have live fire burns on the 1st and 3rd floors only.

All non-Phoenix Fire Department agencies must comply with all existing Phoenix Fire Department procedures relating to live burn training.

COMMAND

One officer on the scene shall be designated as "Command" and will assume the Command functions.

Training Academy chief officer will assume senior advisor role.

A Command Post shall be established and positioned to afford maximum visibility of the structure, operating companies and fire conditions.

COMMUNICATIONS

Command is responsible for establishing radio communications with each company officer or training officer involved in the drill. Channel assignment must be coordinated with Dispatch and Deployment and all companies involved. Companies operating at the training fire will continuously monitor the assigned radio channel. All radios will be checked for proper functioning and correct channel prior to initiating training fire operations.

SECTORS

To eliminate confusion, and provide adequate scene control, all personnel operating within the fireground perimeter shall operate under the direction of a sector officer. The fireground perimeter shall be defined as the hazardous area surrounding the burn structure and shall be determined by Command following guidelines stated in Fireground Safety.

**PHOENIX REGIONAL
STANDARD OPERATING PROCEDURES**

TRAINING ACADEMY ON-SITE BURN BUILDING FIRES

M.P. 202.14A 08/96-R Page 2 of 6

The following sectors shall be established on all burn building fires.

Interior - Company or training officer directing interior suppression activities.

Sector 1, 2 For upper floors, Sector 1, 2, 3, etc. may be used.
etc.

Rescue - Provide a staffed, charged back-up line for each fire attack team, in position to
(RIC) assist in fire extinguishment and rescue of interior personnel. This sector will be
manned by experienced fire fighting personnel (not recruit fire fighters) and each
Rapid Intervention Crew (RIC) shall consist of a minimum of three fire fighters. A
company officer shall be in charge of each RIC unit. There shall be one rescue team
for each fire attack team.

Safety - The Safety officer or a safety representative will be in attendance at all structural
training fires and will assume safety sector responsibilities. The safety sector will
monitor personnel and fire conditions, and work with Command to ensure all safety
procedures are complied with, and that risk to personnel is minimized.

Other Other sectors may be established as necessary to control training/fire control
Sectors - operations and to minimize risk to fire fighters.

SAFETY

The Safety officer shall have full authority to intervene and control or stop any aspect of the operations when in his/her judgment, a potential or real risk to personnel exists. He/she will not be assigned other duties that would distract from his/her safety responsibilities.

Additional Safety officers may be assigned to the training fire if the conditions dictate.

Responsibilities of the Safety Officer(s) will include but not be limited to the prevention of unsafe acts and elimination of unsafe conditions.

Company officers acting as instructors will be responsible for the direct supervision of assigned students and their safety and welfare, including the prevention of unsafe acts and the elimination of unsafe conditions.

Fire department personnel may operate on the roof at the ventilation prop to demonstrate proper vertical ventilation techniques during live fire.

The number of personnel involved in training fires often exceeds the number normally assigned at actual incidents. To reduce risk, and assist with scene management, training fire participants shall be formed into individual companies consisting of no more than four (4) members and be supervised by a company officer.

Exposing recruit fire fighters to live fire conditions presents special safety considerations.

**PHOENIX REGIONAL
STANDARD OPERATING PROCEDURES**

TRAINING ACADEMY ON-SITE BURN BUILDING FIRES

M.P. 202.14A

08/96-R

Page 3 of 6

All fire fighters involved in burn building training fires shall have received training to meet the performance objectives of Firefighter I, NFPA 1001 in:

- Forcible Entry
- Protective Breathing Apparatus
- Fire Hose, Nozzles and Appliances
- Fire Streams
- Ladders
- Ventilation
- Rescue
- Safety
- Fire Behavior

One officer on the scene shall be designated as an accountability officer and will assume the accountability functions.

To enhance accountability and to improve tracking of fire fighters in the Hot Zone, the "PASSPORT" system shall be used,

Personnel Accountability Report or "PAR" shall be used at the following accountability benchmarks:

- Any report of a trapped or missing fire fighter
- By all crews reporting an "All Clear"
- At a report of fire under control
- Upon exiting the structure
- Sudden hazardous event
- Change from offensive to defensive mode
- At the discretion of Command

Passports will remain with the designated accountability officer near the "point of entry" to the Hot Zone. Upon entry, crews will turn in their PASSPORT. Upon exit, the crew must retrieve their PASSPORT. The accountability status board will contain only the PASSPORTS of those crews in the Hot Zone. The Hot Zone shall be clearly marked with fire line tape and understood by all participants.

No personnel shall be permitted to act as a victim(s) during training fires.

To reinforce safety procedures, a protective clothing and equipment inspection shall be conducted on all fire fighters immediately prior and after engaging in suppression activities. The inspection shall insure that all clothing and equipment is serviceable and worn in a manner to provide the maximum personal protection.

**PHOENIX REGIONAL
STANDARD OPERATING PROCEDURES**

TRAINING ACADEMY ON-SITE BURN BUILDING FIRES

M.P. 202.14A

08/96-R

Page 4 of 6

REQUIRED FIRE EQUIPMENT AND COMPANIES

Two separate sources of hydrant water supply shall be established (two engine companies minimum). The water supply shall be test flowed by the forward pumper to insure adequate water supply of a minimum of 500 gallons per minute.

All fire attack hoselines shall be supplied by one pumper with its own hydrant water supply. The RIC unit backup hoselines shall be supplied by a second pumper using a separate hydrant water supply. All hoselines will be flow tested to confirm a minimum of 95 gpm, immediately prior to igniting the fire.

An ALS company and a rescue shall be on scene prior to the start of the burn.

BURN BUILDING PREPARATION

All doors, windows, ventilation props, and standpipes necessary for the training drill shall be checked and operated prior to any live fire conditions to ensure correct operation.

Burn buildings shall be left in a safe condition upon completion of each live fire exercise. Debris hindering the access or egress of fire fighters shall be removed before continuing further operations.

Obtain approvals from Air Quality Control.

Obtain approval from immediate supervisor.

Obtain approval of the safety officer.

STARTING THE FIRE

The use of flammable or combustible liquids, as defined in NFPA-30, shall be prohibited for use in live fire training evolutions. Only Class A materials shall be used in live fire training. A charged and manned hose line shall be in position to provide additional protection. The ignition process will be conducted under the direct supervision of the Safety Officer.

Command shall assign an experienced fire fighter to become "FIRESTARTER." It is the responsibility of the FIRESTARTER to initially ignite the fire. FIRESTARTER shall also regulate the fuel load for each evolution to maintain a tenable atmosphere inside the burn rooms.

The ignition of the fire shall be coordinated through Command so the burn rooms do not become overheated before attack teams make entry.

**PHOENIX REGIONAL
STANDARD OPERATING PROCEDURES**

TRAINING ACADEMY ON-SITE BURN BUILDING FIRES

M.P. 202.14A 08/96-R Page 5 of 6

PRE-PLANNING

A pre-fire tour of the burn building is required.

ATTACK PLAN

The Officer in charge shall develop an attack plan based upon information obtained during the pre-plan and building preparation stages.

The Attack Plan shall specify:

- Points of ignition
- Amount of fire load
- Position of entry attack lines
- Position of RIC units
- A Rescue Plan
- Accountability Plan

All personnel involved in the drill shall be instructed on each element of the attack plan prior to igniting the structure and shall receive a walk through briefing of the building prior to each training fire. An evacuation plan and signal shall be reviewed and agreed upon.

NOTIFICATION OF TRAINING FIRE ACTIVITIES

Prior to conducting burn building training fires, the following notification must be made.

- Dispatch & Deployment
- On-duty Public Information Officer (PIO)
- Safety Officer
- Air Quality Control
- Waste Water Treatment Plant (west)
- Resource Management (south)
- Phoenix Equipment Management (east)
- ADOT maintenance facility (north)

USE OF HOSE STREAMS & EQUIPMENT

The interior protective wall panels will be damaged during live fire training by use of straight stream hose streams. To protect these panels, straight streams will be PROHIBITED during live fire training in Training Academy burn buildings. As these protective wall panels are brittle, care must be taken to prevent breakage. Care should be taken to avoid SCBA bottles or other equipment hitting the walls during training.

**PHOENIX REGIONAL
STANDARD OPERATING PROCEDURES**

TRAINING ACADEMY ON-SITE BURN BUILDING FIRES

M.P. 202.14A

08/96-R

Page 6 of 6

ON-SITE BURN OPERATIONS CHECKLIST

- Adequate fire apparatus on site
- ALS company on-scene
- Rescue on-scene
- Pumpers flow tested for 500 gpm water supply from separate hydrants
- Separate hydrant water sources for each pumper
- Fire load; conservative; not excessive
- Ignition location determined
- Safe ignition fuel utilized
- FIRESTARTER in full protective clothing/SCBA
- Protection line in place for FIRESTARTER; manned and charged
- Training Chief Officer on-scene
- Safety Officer (or representative) on-scene
- Command and sectors established
- Command location identified and announced
- All radios checked for proper functioning/channel
- Sectors established
 - Interior
 - Sectors 1, 2, 3, as needed
 - Rescue (RIC)
 - Safety
 - Ventilation as needed
 - Other
- Accountability officer established
- Attack lines in place, flow tested for a minimum of 95 gpm each
- RIC lines in place, flow tested for a minimum of 95 gpm each
- RIC staffed by minimum of three fire fighters
- One RIC unit in place (with hoseline) for each attack entry team
- Attack lines from one pumper, RIC lines from a separate pumper
- Fire attack entry and RIC units in full protective clothing, PASS and SCBA checked for proper functioning
- Company officers in charge of each attack and RIC unit
- Attack plan established and understood by all
- Walk through briefing conducted for all crews
- Rescue plan established and understood by all
- PASSPORTS and status boards near point of entry
- Rehab established

POST BURN ACTIVITIES

The building shall be left in a safe condition upon completion of live fire training. All hot spots shall be completely extinguished to prevent re-kindle. It is recommended that an infrared camera be utilized to locate hot spots. Members shall be rehabed and re-hydrated. Protective clothing and SCBA's shall be rinsed clean.

**PHOENIX REGIONAL
STANDARD OPERATING PROCEDURES**

ON-SITE FLASHOVER CHAMBER FIRES

M.P. 202.14B

08/96-N

Page 1 of 5

PURPOSE

The purpose of this procedure is to establish standard guidelines for conducting on-site training fires in the Emergency Services Institute (ESI) flashover chamber, while complying with NFPA Standard 1403. All other Phoenix Fire procedures will apply to training fires where applicable.

GENERAL USAGE

Any Fire Department member or outside agency wishing to use the flashover chamber must first obtain permission from an ESI chief officer.

The time and date of the training drill must be scheduled with the ESI staff. Drills involving Recruit Training and Departmental Training always have first priority.

An officer representing the ESI staff must be on-site for any live fire drills involving the flashover chamber. A fee may be charged to outside services/agencies.

The flashover chamber has been designed specifically for the purpose of repeated live fire training evolution's and include safeguards that only become unacceptably hazardous through misuse and neglect.

COMMAND

One officer on the scene shall be designated as "Command" and will assume the Command functions.

A Command Post shall be established and positioned to afford maximum visibility of the structure, operating companies and fire conditions.

COMMUNICATIONS

Command is responsible for establishing radio communications with each company officer or training officer involved in the drill. Channel assignment must be coordinated with Dispatch and Deployment and all companies involved. Companies operating at the training fire will continuously monitor the assigned radio channel. All radios will be checked for proper functioning and correct channel prior to initiating training fire operations.

SECTORS

To eliminate confusion, and provide adequate scene control, all personnel operating within the fireground perimeter shall operate under the direction of a sector officer. The fireground perimeter shall be defined as the hazardous area surrounding the burn structure and shall be determined by Command following guidelines stated in Fireground Safety.

The following sectors shall be established on all flashover chamber fires.

Interior - Training officer directing interior activities.

Rescue - Provide a staffed, charged back-up line for each fire attack team, in position to assist in fire extinguishment and rescue of interior personnel. This sector will be staffed (RIC) by experienced fire fighting personnel (not recruit fire fighters) and each Rapid Intervention Crew (RIC) shall consist of a minimum of three fire fighters. A company

**PHOENIX REGIONAL
STANDARD OPERATING PROCEDURES**

ON-SITE FLASHOVER CHAMBER FIRES

M.P. 202.14B

08/96-N

Page 2 of 5

officer shall be in charge of each RIC unit. There shall be one rescue team for each fire attack team.

Safety - The safety officer or a safety representative will be in attendance at all flashover chamber training fires and will assume safety sector responsibilities. The safety sector will monitor personnel and fire conditions, and work with Command to ensure all safety procedures are complied with, and that risk to personnel is minimized.

Other Sectors - Other sectors may be established as necessary to control training/fire control operations and to minimize risk to fire fighters.

SAFETY

The safety officer ~~shall have full authority to intervene and control or stop~~ any aspect of the operations when in his/her judgment, a potential or real risk to personnel exists. He/she will not be assigned other duties that would distract from his/her safety responsibilities.

Safety officer shall conduct a protective clothing inspection for each member prior to entering the chamber.

Additional safety officers may be assigned to the training fire if the conditions dictate. Responsibilities of the safety officer(s) will include but not be limited to the prevention of unsafe acts and elimination of unsafe conditions.

Company officers acting as instructors will be responsible for the direct supervision of assigned students and their safety and welfare, including the prevention of unsafe acts and the elimination of unsafe conditions.

The number of personnel involved in training fires inside the flashover chamber shall be limited to ten (10) personnel. To reduce risk, and assist with scene management, training fire participants shall be formed into individual teams consisting of no more than eight (8) members and supervised by two (2) qualified flashover chamber instructors.

Exposing recruit fire fighters to live fire conditions presents special safety considerations.

All fire fighters involved in flashover chamber training fires shall have received training to meet the performance objectives of:

- Protective Breathing Apparatus
- Fire Hose, Nozzles and Appliances
- Fire Streams
- Ventilation
- Rescue
- Safety
- Fire Behavior

One officer on the scene shall be designated as an accountability officer and will assume the accountability functions.

**PHOENIX REGIONAL
STANDARD OPERATING PROCEDURES**

ON-SITE FLASHOVER CHAMBER FIRES

M.P. 202.14B 08/96-N Page 3 of 5

To enhance accountability and to improve tracking of fire fighters in the Hot Zone, the "PASSPORT" system shall be used,

Personnel Accountability Report or "PAR" shall be used at the following accountability benchmarks:

- Upon entry
- Any report of fire fighter in distress
- Upon exiting the structure
- Sudden hazardous event
- At the discretion of command

Passports will remain with the designated Accountability Officer near the "point of entry" to the flashover chamber. Upon entry, crews will turn in their PASSPORT. Upon exit, the crew must retrieve their PASSPORT. The accountability status board will contain only the PASSPORTS of those teams in the flashover chamber.

No personnel shall be permitted to act as a victim(s) during training fires.

To reinforce safety procedures, a protective clothing and equipment inspection shall be conducted on all fire fighters before and after the flashover training. The inspection shall insure that all clothing and equipment is serviceable and worn in a manner to provide the maximum personal protection.

REQUIRED FIRE EQUIPMENT AND COMPANIES

Two separate sources of water supply shall be established (one Engine and one Tender minimum). The water supply shall be test flowed by the forward pumper to insure adequate water supply of a minimum of 500 gallons per minute.

All fire suppression hoselines shall be supplied by one pumper. The RIC unit backup hoselines shall be supplied by a Tender. All hoselines will be flow tested to confirm a minimum of 95 gpm, prior to igniting the fire.

All members shall have a full SCBA bottle prior to entering the flashover chamber. ALS capabilities shall be maintained on-scene during training fires.

FLASHOVER CHAMBER PREPARATION

All doors, and smoke vents necessary for the training drill shall be checked and operated prior to any live fire conditions to ensure correct operation.

The flashover chamber shall be left in a safe condition upon completion of live fire training. Debris hindering the access or egress of fire fighters shall be removed before continuing further operations.

After each flashover exercise, all fire debris shall be removed with care and completely extinguished.

Obtain approval from Air Quality Control.
Obtain approval from immediate supervisor.
Obtain approval of the safety officer.

**PHOENIX REGIONAL
STANDARD OPERATING PROCEDURES**

ON-SITE FLASHOVER CHAMBER FIRES

M.P. 202.14B

08/96-N

Page 4 of 5

STARTING THE FIRE

The use of flammable or combustible liquids as defined in NFPA 30, shall be prohibited for use in live fire training evolutions. Only Class A materials shall be used in live fire training. A charged and manned hose line shall be in position to provide additional protection. The instructor will load the container with boards of fibrous material. He will make sure the wall and ceiling boards are placed as close together as possible and ensure the ceiling boards are pressed against the ceiling to prevent combustible gas pockets. A considerable amount of combustible gas is lost if there is a fire between the boards and the ceiling. (The combustible gas is what produces and demonstrates the flashover).

The initial fire shall be of dry fibrous material and shall be placed in one corner of the fire room. Make sure the roof hatch is working and that the door and the side hatch are easy to open. The ignition process will be conducted under the direct supervision of the safety officer. Command shall assign an experienced fire fighter to become "FIRESTARTER". It is the responsibility of the FIRESTARTER to initially ignite the fire. FIRESTARTER shall also regulate the fuel load for each evolution to maintain a tenable atmosphere inside the flashover chamber.

The ignition of the fire shall be coordinated through Command so the flashover chamber does not become overheated before observation teams make entry.

PRE-PLANNING

A pre-fire tour of the flashover chamber is required.

PRE-ENTRY BRIEFING

The Instructor in charge shall develop a briefing to include these important points:

- History and Development of Flashover Chamber
- Purpose of exercise
- Observe character of the combustible gases
- Observe neutral zone
- Observe air supply
- Observe differences of pressure
- Observe extinguishing effect

All personnel involved in the drill shall be instructed on each element of the plan prior to igniting the initial fire and shall receive a walk through briefing of the chamber prior to each training fire. An evacuation plan and signal shall be reviewed and agreed upon.

NOTIFICATION OF TRAINING FIRE ACTIVITIES

Prior to conducting flashover chamber training fires, the following notifications must be made.

- Dispatch & Deployment
- On-duty Public Information Officer (PIO)
- Safety Officer
- Air Quality Control
- Solid Waste Management to the (east)

**PHOENIX REGIONAL
STANDARD OPERATING PROCEDURES**

ON-SITE FLASHOVER CHAMBER FIRES

M.P. 202.14B

08/96-N

Page 5 of 5

ON-SITE BURN OPERATIONS CHECKLIST

- Adequate fire apparatus on site
- ALS capabilities on-scene
- Pumper and Tender flow tested for 500 gpm water supply
- Fire load; conservative; not excessive
- Ignition location determined
- Safe ignition fuel utilized
- FIRESTARTER in full protective clothing/SCBA
- Protection line in place for FIRESTARTER; manned and charged
- Training Chief Officer on-scene
- Safety officer (or representative) on-scene
- Command and sectors established
- Command location identified and announced
- All radios checked for proper functioning/channel
- Sectors established
 - Interior
 - Rescue (RIC)
 - Safety
 - Other
- Accountability Officer established
- Suppression line in place, flow tested for a minimum of 95 gpm each
- RIC lines in place, flow tested for a minimum of 95 gpm each
- RIC manned by minimum of three fire fighters
- One RIC unit in place (with hoseline) for each observation team
- Suppression lines from one pumper, RIC lines from a separate pumper or tender
- Flashover chamber participants and RIC units in full protective clothing, PASS and SCBA checked for proper functioning
- Flashover chamber instructors in charge of each observation team and RIC unit
- Operating plan established and understood by all
- Walk through briefing conducted for all crews
- Rescue plan established and understood by all
- PASSPORTS and status boards near point of entry
- Protective clothing and SCBA's shall be decontaminated

**PHOENIX REGIONAL
STANDARD OPERATING PROCEDURES**

BRUSH/WILDLAND FIRE

M.P. 202.15

04/20-R

Page 1 of 10

PURPOSE

This plan is intended to serve as an operational guide when serious dry vegetation fires are encountered. All Phoenix Regional standard operating procedures are in effect for WILDLAND fire fighting except as amended or superseded by this plan.

OVERVIEW

The desert areas near Phoenix and surrounding communities occasionally see vegetation fires that grow in complexity and resource needs. Oftentimes, these fires burn across jurisdictional boundaries with state, tribal and federal lands. These fires typically are responded to by agencies from the Phoenix Regional Dispatch System and create a low frequency, high risk incident for our personnel. Firefighter safety is the primary objective for brush/wildland fire incidents.

Several jurisdictions of the Phoenix metropolitan area experience these types of incidents more so than others. With this in mind, agencies with brush/wildland areas may have additional training, capabilities and guidelines specific to their agency. Some agencies may constant staff water tenders and brush trucks during brush fire season as conditions dictate.

Brush/wildland fires that occur on state, tribal or federal lands may have resources respond for suppression and command needs. The agencies include the Arizona Department of Forestry and Fire Management, Bureau of Indian Affairs, Bureau of Land Management, U.S. Forest Service, and resources include engines, hand crews, aircraft and supervisory personnel. In some cases, these agencies may prefer to form Unified Command with initial Phoenix Regional Dispatch units or relieve the command when the fire is exclusively on state, tribal or federal jurisdiction.

DEFINITIONS

1. Air Attack - Aerial reconnaissance aircraft which can provide information from above the fire by an observer.
2. Air Tanker -Fixed wing aircraft certified by the FAA as being capable of transport and delivery of fire retardant solutions.
3. VLAT – Very Large Air Tanker – Fixed wing heavy Air Tanker DC10, 737, and larger in some cases.
4. Buoy Wall Tank (Pumpkin)- Large 1500 to 4000-gallon collapsible water tank carried on some water tenders used for a remote water source or fill station for Bambi Bucket operations. These are not to be confused with a Fol-Da-Tank not designed for Bambi Bucket operations.
5. Bambi Bucket – Small 65 to 95-gallon bucket, externally attached to helicopters for water drops on brush fires.
6. Division - Similar to a “sector”. A geographic work assignment (example East Division, or Division A)
7. Group - Similar to a “sector”. A functional work assignment (example Water Supply Group)
8. LCES - Lookouts, Communications, Escape Routes, Safety Zones. A basic safety measure that must be in place at all times for firefighter safety.
9. Red Flag Warning - A weather announcement made by the National Weather Service when fire danger is Very High or Extreme. Sustained winds \geq 20 mph and relative humidity \leq 20%,

**PHOENIX REGIONAL
STANDARD OPERATING PROCEDURES**

BRUSH/WILDLAND FIRE

M.P. 202.15

04/20-R

Page 2 of 10

scattered thunderstorms, increased thunderstorm activity after a prolonged dry period, abrupt change in wind speed and direction that may affect the area.

10. SEAT - Single Engine Air Tanker (similar to a crop duster) A fixed wing aircraft capable of transport and delivery of fire retardant solutions of about 800 gallons.
11. Type 1 Engine - A typical structure engine. Crew of 4 personnel, minimum 400-gallon tank and 1000 gpm pump.
12. Type 3 Engine- Typically a short wheelbase engine capable of both structure and wildland fire operations. Commonly 4-wheel drive, 500-gallon tank, 250 gpm pump.
13. Type 6 Engine- Approx. 200-gallon tank and 50 gpm pump with higher pump pressure capacity than an engine and pump-and-roll capability. Typically, 4-wheel drive for off-road fire suppression.
14. Water Tender ("Tender") - A water transport and delivery fire apparatus. Capable of carrying 1000 to 5000 gallons of water. Pumps may range from 50 to 1500 gpm.
15. Tactical Tender – Has pump and firefighting capabilities.
16. Support Tender – Delivery of water only.
17. Wildland Fire - Any non-structure fire that occurs in the wildland.

POLICY

Resources responding to a brush/wildland fire will be familiar with National Incident Management System (NIMS) terminology and practices. Resources should be prepared to work in Sector/Division/Group assignments or other positions with resources from outside the regional dispatch system.

Wildland fires typically demand a significant command and support staff to manage and will often require resources from other Fire Departments and Government agencies. Command will be responsible for requesting all needed resources.

Any WORKING FIRST ALARM BRUSH assignment or greater will be deemed a wildland fire and receive appropriate additional resources. Dispatch will activate the "All Call," announce a wildland fire, and provide the incident address. Dispatch will contact the Arizona Department of Forestry and Fire Management to inform them of the location/jurisdiction of the incident, the ID and location of the incident commander, and fire spread potential.

Staff Officers will respond to multiple alarm wildland and brush fires as they do other multiple alarm incidents and report to their pre-assigned responsibilities or staging. Command will assign this staff support as needed.

The following resources will be dispatched for a brush/wildland incident:

STILL BRUSH

- Engine
- Brush

**PHOENIX REGIONAL
STANDARD OPERATING PROCEDURES**

BRUSH/WILDLAND FIRE

M.P. 202.15

04/20-R

Page 3 of 10

BRUSH ASSIGNMENT

- 2 - Engines
- 2 - Brush Trucks
- 1 - Water tender
- 1 - Command Officer
- 1 - Rescue (or ambulance)

FIRST ALARM BRUSH

- 5 - Engines
- 4 - Brush Trucks
- 2 - Water tenders
- 3 - Command Officers
- 1 - Shift Commander
- 1 - Command Van
- 1 - Safety Officer
- 1 - Rehab Unit
- 1 - Canteen Unit
- 1 - Rescue (or ambulance)
- 2 - CXX19

The following support resources will be dispatched for SECOND ALARM BRUSH assignments or greater:

GREATER ALARM BRUSH

- 5 - Engines
- 4 - Brush Trucks
- 2 - Water tenders
- Staff and Command Officer Response
- Port-A-Potties
- Refueling Truck
- Mechanics
- Radio Technician
- Multiple Spare Radios
- All available CXX19s
- Weather Reports

FIRE FIGHTER SAFETY

PPE

In the brush/wildland fire setting, proper personal protective equipment (PPE) is essential to fire fighter safety. Structural turnout coats, pants and boots are not designed for brush/wildland fire suppression.

**PHOENIX REGIONAL
STANDARD OPERATING PROCEDURES**

BRUSH/WILDLAND FIRE

M.P. 202.15

04/20-R

Page 4 of 10

Wildland PPE is designed to be more comfortable and functional while reducing fire fighter fatigue and heat-related injuries.

A proper brush/wildland fire protective ensemble will consist of a helmet, fire resistive brush shirt/jacket, fire resistive brush pants, eye and hearing protection, work gloves and leather ankle high boots. Nylon hiking boots are inappropriate because of the melting and sticking potential of nylon.

Some regional agencies may have additional protective equipment guidelines that exceed these minimum standards.

Hydration

Remember that heat is a major safety problem and all personnel should be kept well hydrated. Personnel should have access to drinking water and carry canteens or similar water containers. Sterile water bottles can be cleaned, filled with drinking water, and carried in the brush jacket pockets.

Wildland fire fighting is a physically demanding operation and members should be fit and prepared mentally for a very hot, fast moving, and dangerous environment.

Crew Safety

Wildland fires demand that Company Officers maintain a high level of awareness regarding crew accountability. Crew members can easily become spread out and not visible in rugged and rocky terrain. Company Officers must maintain LCES (Lookouts, Communication, Escape Routes, and Safety Zones) and control over crew members to ensure a safe operation. Wildland fire fighting will still employ the buddy system. Watch out for each other.

ANY DEPARTMENT UTILIZING DRONES DURING A BRUSH/WILDLAND FIRE INCIDENT WILL IMMEDIATELY LAND THE DRONE AS SOON AS ANY AIRCRAFT HAS BEEN ORDERED. THIS WILL ENSURE THE SAFETY OF INCOMING AIRCRAFT AND EXPEDITE THE USE OF AIRCRAFT FOR FIREFIGHTING OPERATIONS. REMEMBER: NO AIRCRAFT CAN FLY ON A FIRE IF A DRONE IS UP.

Ten Standard Fire Orders

Wildland fires are fast moving and extremely dangerous. These scenes require that all personnel understand these basic wildland fire fighting orders:

1. Keep informed on fire weather conditions and forecasts.
2. Know what the fire is doing at all times.
3. Base all actions on current and expected behavior of the fire.
4. Identify escape routes and safety zones and make them known.
5. Post lookouts when there is possible danger.
6. Be alert. Keep calm. Act decisively.
7. Maintain prompt communications with your forces, supervisor, and adjoining forces.
8. Give clear instructions and insure they are understood.

**PHOENIX REGIONAL
STANDARD OPERATING PROCEDURES**

BRUSH/WILDLAND FIRE

M.P. 202.15

04/20-R

Page 5 of 10

9. Maintain control of your forces at all times.
10. Fight fire aggressively, having provided for safety first.

Eighteen Watch Out Situations

Several situations have been found to increase the chance of injuries or fatalities on brush/wildland fires. These include:

1. Fire not scouted or sized-up.
2. In country not seen in daylight.
3. Safety zones and escape routes not identified.
4. Unfamiliar with weather and local factors influencing fire behavior.
5. Uninformed on strategy, tactics and hazards.
6. Instructions and assignments not clear.
7. No communications link with crewmembers/supervisor.
8. Constructing line without a safe anchor point.
9. Building fire line downhill with fire below.
10. Attempting a frontal assault on the fire.
11. Unburned fuel between you and the fire.
12. Cannot see the main fire or not in contact with anyone who can.
13. You are on a hillside where rolling material can ignite fuel below.
14. Weather is getting hotter and drier.
15. Wind increases and/or changes direction.
16. Getting frequent spot fires across the line.
17. Terrain and fuels make escape to safety zones difficult.
18. Taking a nap near the fire line.

FIRE BEHAVIOR

The following factors have a critical effect on the fire behavior of a wildland fire. Command must maintain an awareness of these conditions and be prepared to react quickly, pessimistically and well ahead of the fire. The factors are: WEATHER, FUEL, and TOPOGRAPHY.

Weather

Command must be aware of constantly changing weather conditions. During a normal day, local winds will change 180 degrees near midday and usually become gusty during the afternoon. Morning winds are normally East to West and afternoon winds are usually West to East. Fire spread will usually slowdown in the evening AS HUMIDITY INCREASES (25%) and increase during the midmorning hours AS THE HUMIDITY DECREASES (15%).

A Red Flag Warning issued by the National Weather Service indicates when conditions are present that may have substantial effects on any brush/wildland fire incidents during that period. Crews should give special consideration to any fire incident under these conditions.

Command should always be aware of the fire conditions, weather conditions and time of day. Remember that a large WILDLAND fire can create dangerous convection currents that cause erratic

**PHOENIX REGIONAL
STANDARD OPERATING PROCEDURES**

BRUSH/WILDLAND FIRE

M.P. 202.15

04/20-R

Page 6 of 10

fire behavior and spot fires far in advance of the fire head. Heavy winds also produce similar results.

Hot and dry conditions produce extremely rapid-fire spread. A slight decrease in relative humidity will cause a significant increase in fire intensity. During extreme days surface-wetted fuel will dry in a few minutes.

Fuel

Most of the fuel in the Phoenix area is relatively light and burns very rapidly. Fires will be mostly wind driven and depending on fuel loading could require extensive overhaul. Fuels in the river bottoms are usually a mix of grass, brush, and trees which will increase fire behavior and the time it takes to extinguish them.

Topography

Fire burns uphill much more rapidly than downhill. On an uphill slope, the fire will tend to crown over the top and start spot fires a considerable distance down the receding slope. A large free-burning fire will tend to create its own convection currents and spot fires may be started. Access is often the most serious problem with topography.

Companies with considerable brush fire potential should size-up areas with regard to fuel, topography and extent of exposure to structures. Particular attention should be paid to access roads and accessible areas where apparatus may travel. Natural fire breaks and potential exposure problems should be noted on the area maps provided for this purpose.

COMMAND

The first arriving company officer who assumes Command must address the values at risk. This includes life safety, structures threatened, fire control, and property conservation benchmarks. In a wildland fire setting the life safety benchmarks must include fire fighters as well as civilians. Command must have a plan that includes LCES (Lookouts, Communications, Escape Routes and Safety Zones) for fire fighters and equipment. LCES should be in place prior to any fire suppression operations. Individual sectors can establish escape routes and safety zones depending on need or location. Escape routes and safety zones should be easily accessible and large enough to prevent radiant heat injuries or direct flame impingement. Aerial operations should not be located near safety zones.

- Command should concern itself with strategy and allow sectors to dictate tactics
- Make early offensive/defensive (direct attack or indirect attack) decisions
- Gather adequate resources
- Think ahead - way ahead
- Support sectors
- Protect and rehab fire fighters
- Consider assigning an ALS company and a rescue for medical response for firefighters
- Consider filling the operations chief and/or logistics chief position early into the incident

**PHOENIX REGIONAL
STANDARD OPERATING PROCEDURES**

BRUSH/WILDLAND FIRE

M.P. 202.15

04/20-R

Page 7 of 10

On major incidents, establish a Command Post and sectors/divisions/groups as soon as possible. The Command Post should be in a location which will be safe and not have to move if the fire changes direction. Supporting elements should be able to set up at the Command Post. Select a site where a helicopter may land in close proximity to the Command Post.

The Command Post will need to plot progress, exposures and access. The units in the field, particularly geographic sectors/divisions/groups, will have to report this information back to Command via radio or personal contact.

As fire spread becomes critical, Command must be prepared to special call additional attack units by specific companies or to request assistance by standardized alarm responses. This determination must be made early.

When brush/wildland fires begin to threaten homes, Command must be prepared to readjust and develop a defensive strategy to protect exposures while allowing the fire to burn to a location better suited for control.

TACTICS AND STRATEGY

Brush fires often present a large area of rapidly spreading fire. The critical decision is often where to attack the fire to the best advantage. Protection of exposures is the primary goal when immediate control is not possible.

Size Up

A deliberate and thorough initial size up is extremely important on significant or potentially significant fire incidents in order to develop a fire fighting plan. The initial incident commander should take the necessary time to gather pertinent information on the fires location, spread rates and direction, identified hazards, any threats to improvements (structures, power lines, etc) and anticipated needed resources. The following is a list of size-up considerations that greatly affect tactics and strategy:

Fire:

- Location of fire head or heads
- Size of fire and rate of speed
- Flame length
- Spot fires
- Accessibility into fire area

Fuel:

- Fuel continuity
- Type of fuel—grass, brush, trees
- Fuel loading - light, heavy

Weather:

**PHOENIX REGIONAL
STANDARD OPERATING PROCEDURES**

BRUSH/WILDLAND FIRE

M.P. 202.15

04/20-R

Page 8 of 10

- Temperature
- Wind speed and direction
- Relative Humidity

Topography:

- Is it flat ground or on hillside
- Bottom, middle or top of hill

Hazards:

- Exposures--improvements, buildings, crops, etc.
- Special hazards (e.g., spot fires, hazardous materials, etc.)

Resources

- Manpower needs
- Water resource (e.g., tenders, hydrants, etc.)

Command must then quickly develop an incident action plan based on this size up.

Direct Attack (Offensive)

Direct attack should be used whenever fire conditions allow fire personnel to work directly and safely on the fires edge. Personnel should “anchor and flank” a fire by first establishing a safe location, or anchor point, to start the attack without being outflanked by fire. An example of an anchor point would be a road or green farm field.

Fire suppression personnel on fires in light fuels should use the “one foot in the black” method in an inside out attack where the safety zone is the previously burned area adjacent to the burning fire front. Unlike a structural fire attack, a brush/wildland fire attack should be from the BURNED (black) side where possible. Structural fire fighters can find themselves entrapped by fire when attacking a fire head-on from the unburned side where fire can quickly overrun them.

A direct water attack is the fastest control evolution available to counteract wildfire spread. Brush trucks can accomplish this through pump-and-roll tactics. Apparatus and personnel should be in the burned (black) area as opposed to the unburned fuels.

Indirect Attack (Defensive)

Indirect attack methods are used when fire personnel are prohibited from direct attack due to fire conditions or access to the fire. For indirect attack strategy, fire personnel work some distance away from the fires edge. This may be in support of wildland fire crew burnout operations, structure protection or another tactic.

On large open grass fires, Command must take advantage of natural fire barriers that will assist in control measures, such as: dry sandy washes, roads, trails, rock outcroppings, patch fuels, etc.

**PHOENIX REGIONAL
STANDARD OPERATING PROCEDURES**

BRUSH/WILDLAND FIRE

M.P. 202.15

04/20-R

Page 9 of 10

Structure Protection/Interface Operations

During interface fires involving brush and structures it may be necessary to retain a 3-1 structural assignment in staging and be prepared to assign those units to conduct structural firefighting if needed. These staged resources will be turned out and equipped to carry out interior structural firefighting.

Units assigned to protect a structure or improvement should first thoroughly size up the site to ensure firefighter safety can be maintained. The Company Officer should walk the driveway or access road to ensure apparatus have good access and clearance and that the site is deemed safe to protect. Apparatus should back-in to allow for quick egress is necessary.

During structure protection, crews should plan to remain as mobile as possible in case escape is necessary. Hose lays should be as short as possible and limited to one or two at most. "Bump bags" or other hose packs may be used by some regional departments that have more frequent or substantial interface areas. These hose packs consist of 1 ½" "trunk" line with a gated "y" and one or two 1" forestry hose lines with nozzle.

When water is in short supply, it is usually most effective when applied to burning material instead of wetting fuel in advance. Seriously exposed structures should be kept wet, using appropriate foam if possible.

Tactical challenges and hazards for structure protection:

(Firefighters with a safety zone can safely defend structures with some challenges)

- Narrow roads, unknown bridge limits, and septic tank locations
- Ornamental plants and combustible debris next to structure
- Wooden siding and/or wooden roof materials
- Open roof vents, eaves, decks, and other ember traps
- Fuel tanks and hazardous materials
- Power lines
- Limited water sources
- Property owners remaining onsite

MOP-UP

After direct or indirect line work is completed and a fire is called "Under Control," many things remain to be done to make the fire line safe and put the fire out. This work is called mop up. The objective of mop up is to put out all fire embers or sparks to prevent them from crossing the fire line.

A certain amount of mop up work is done along with line building. Mop up becomes an independent part of firefighting as soon as the spread of the fire is stopped, and all line has been completed. Ordinarily, mop up is composed of two actions; putting the fire out, and disposing of fuel either by burning to eliminate it, or removing the fuel so it cannot burn. The principles of mop up follow:

1. Start work on each position of line just as soon as possible after line construction and burning out are completed. Treat most threatening situations first.

**PHOENIX REGIONAL
STANDARD OPERATING PROCEDURES**

BRUSH/WILDLAND FIRE

M.P. 202.15

04/20-R

Page 10 of 10

2. Allow fuel to burn up if it will do so promptly and safely.
3. On small fires, all fire should be extinguished in the mop up, where quantities of burning material are not so large as to make this impractical.
4. On large fires, completely mop up enough of the area adjacent to the line to be certain no fire can blow, spot, or roll over the fire line under the worst possible conditions.
5. Search for smoldering spot fires.
6. All smoldering material that is not put out with water or dirt should be spread well inside of lines.
7. Eliminate or put into a safe area all less flammable fuels, such as rotten logs and snags, which are outside, but near the control line.
8. Eliminate all burned trees inside of line that could throw sparks over line or fall over the line.
9. Put all rolling material in a position that it cannot possibly roll across the line.
10. Look for indications of hot spots. Some are gnats swarming, white ash, ground which shows pin holes, and wood boring insects.
11. Use water wherever possible and practical in mop up.
12. Use water sparingly but use enough to do the job. Match the amount of water to the job.
13. Adding Class A foam to water will greatly increase effectiveness in mop up of deep-burning fuels.

When addressing mop up operations, Command should:

1. Determine the distance inside the control line to be overhauled (for small fires, this may be the entire burn area).
2. During rehab of mop up crews, ensure at least two fire fighters remain in the area to monitor for re-ignition or spread of fire.
3. Schedule for follow-up checks by crews to ensure the fire is out in mopped up perimeter.

**PHOENIX REGIONAL
STANDARD OPERATING PROCEDURES**

BRUSH/WILDLAND FIRE AIR SUPPORT

M.P. 202.15A

12/12-R

Page 1 of 3

Purpose

To ensure the safe and effective use of aerial firefighting resources on a wildland / brush fire within the areas protected by Phoenix Regional Departments.

Overview

Aerial firefighting resources are an effective tool when dealing with a wildland / brush fire. Their functions are imperative to fire suppression activities. Some of these functions include delivering water or fire retardant to inaccessible areas; assist in completing fire line gaps and cooling the head or flanks of a fast spreading fire. However, it must be noted that the use of aircraft dramatically increases the hazard level of the fire ground and adds a greater responsibility on the incident commander. The benefits must be weighed against the risks. The following guidelines should be in place when using aerial resources.

Definitions

Air Attack: Air Attack is a fixed wing aircraft with a pilot and air attack group supervisor on board. The air attack group supervisor responsibility is to coordinate with command, aircraft and ground forces ensuring aircraft safety, correct drop locations as requested by ground forces and to act as aerial recon for all ground forces.

Rotary wing: Rotary wing aircraft is a helicopter used on an incident for recon, crew shuttle and water drops.

Fixed wing: Fixed wing aircraft include any airplane used on an incident for air resource coordination, a.k.a. air attack, or retardant drops.

Types of fixed wing aircraft

S.E.A.T: Single engine air tanker holding 600 – 800 gallons of retardant.

Large Air Tanker: holds up to 3000 gals of retardant.

Very Large Air Tanker: A very large air tanker is a DC10 holding 10,000 gallons of retardant.

Lead plane: A lead plane is aircraft used as a guide for heavy and large air tankers to mark flight routes and drop sites.

Landing zone: A landing zone is a large area, clear of obstructions, where rotary wing aircraft can land.

Dip Site: A dip site is a large area clear of obstructions, with a 300' approach and departure path clear of structures and personnel with a water supply from a lake, pond or buoy wall that can be supplied by a water tender or engine utilizing a hydrant.

(Note: on a wildland fire ground, large aircraft are referred to as tankers and water hauling equipment is a tender.)

Requesting Aircraft

When it is determined that aerial resources are needed, contact Alarm and request the type of aircraft desired. Alarm can dispatch local resources such as Phoenix PD, Mesa PD and DPS Ranger 41. Other rotary wing aircraft and fixed wing aircraft must come through an interagency order from Arizona State Forestry which will include State and Federal resources. When requesting these resources, ask for air attack in addition to the suppression aircraft. When State or Federal resources arrive on scene, local air resources must leave the incident per State and Federal guidelines.

**PHOENIX REGIONAL
STANDARD OPERATING PROCEDURES**

BRUSH/WILDLAND FIRE AIR SUPPORT

M.P. 202.15A

12/12-R

Page 2 of 3

Communications

All aircraft shall be on a secure radio channel with the position of air operations being the ground contact located at the incident command post. All request for water / retardant drops must go through command to Air Operations who will assign an aircraft for the drop. Air Operations will provide pilot the location of the drop on the fire and the radio channel of the ground contact in order to ensure proper drop location. After the drop, the aircraft will contact Air Operations on the Air Operations channel. The dip site manager shall monitor the Air Operations channel.

Aircraft use and restrictions

Considering the hazards associated with low flying aircraft, the following shall be adhered to.

- Aircraft used for water / retardant drops shall not be used at night.
- Rotary wing aircraft carrying an external load, i.e. bambi buckets, shall not fly over occupied structures. All structures should be considered occupied.
- All State and Federal resources must be on the ground 30 minutes prior to sunset. The Incident commander must consider the tactical challenges this could cause when constructing the incident action plan.

Dip Site / L.Z/Helisports location

Dip sites / Landing zones/Helisports should be set up within proximity to the incident; however, not close enough to interfere with ground operations. The following should be considered:

- Approach and departure routes must be clear 300' in all directions
- Terrain should be flat and paved if possible
- Dust control procedures must be in place
- Water supply location: is there a hydrant close by or is a water tender going to be utilized for a shuttle operation or to supply a Buoy Wall.
- Travel time to and from the fire line along with travel routes
- Wind direction and a plan for potential wind shifts effecting approach and departure.

PROGRESS REPORTING TO COMMAND

Progress reports on the effectiveness of water drops on the fire from Sectors to Command are essential. Sectors will advise Command of the need for water drops and provide specific locations. Unless otherwise directed by Command, Sectors and crews do not communicate directly with the helicopter pilot.

**PHOENIX REGIONAL
STANDARD OPERATING PROCEDURES**

BRUSH/WILDLAND FIRE AIR SUPPORT

M.P. 202.15A

12/12-R

Page 3 of 3

Safety

Working with Air Tankers

- Have a plan: determine tactics based on strategy- direct or indirect based on fire size up.
- Order appropriate aircraft for mission; aircraft should support ground resource tactics.
- Establish effective communication with Air Operations or Air Attack.
- Discuss strategy, tactics, wind condition and hazards with Air Operations or Air Attack.
- Establish an anchor point and work from it or towards it with aircraft.
- Order aircraft early; aircraft are most effective during initial attack.
- Let ground resources know when there is aircraft inbound.
- Ensure approach, departure and line is clear of personnel and equipment.
- Inform Air Operations, Air Attack or pilot when the drop area is clear.
- Let ground resources know when drops are completed on a division or segment of line.
- Get feedback from on-scene ground resources regarding drop effectiveness.
- Relay feedback to aerial resource.

Aerial water and retardant drop

Clear personnel out of target area prior to drops. If you can't escape:

- Hold your hand tool away from your body
- Lie face down with head toward oncoming aircraft and hard hat in place. Grasp something firm to prevent being carried or rolled about by the drop liquid.
- Do not run unless escape is assured.
- Get clear of dead snags, tops and limbs in drop area.
- Working in an area covered by wet retardant should be done with caution due to slippery surfaces.

Approach and departure

- Stay clear of landing area during approach and departure.
- Always approach/depart from the down-slope side as directed by the pilot.
- Approach/depart helicopter in a crouched position.
- Do not run.
- Keep in pilots view at all times.
- Do not reach up or chase after loose objects.
- Never approach the tail section of the helicopter.
- **No smoking** within 50' of the aircraft.

**PHOENIX REGIONAL
STANDARD OPERATING PROCEDURES**

URBAN-INTERFACE DEPLOYMENT

M.P. 202.15B

04/20-N

Page 1 of 2

PURPOSE

The purpose of this procedure is to establish a standard deployment for wildland-urban interface fire incidents.

DEFINITIONS

Wildland-urban interface is defined as the zone of transition between wildland (or unoccupied land) and human development.

POLICY

A growing number of fire departments within the Central Arizona Life Safety Response Council (CALSSRC) face the problem of protecting the wildland-urban interface. Fire Departments must continue to focus on the unique fire protection challenges associated with the wildland-urban interface.

Through a systematic process of pre-incident planning, Company Officers are responsible for the identification of areas within their first-due that are at risk for an urban-interface fire incident. These areas should be reported to their Battalion Chief for identification in the CAD system. Once entered into the CAD system, any reported brush fire incident will have an urban-interface assignment deployed by the dispatch center.

The following resources will be dispatched for an urban-interface incident:

URBAN-INTERFACE ASSIGNMENT:

- 5 – Engines
- 1 – Ladder
- 3 – Brush Trucks
- 2 – Tenders
- 2 – Command Officers
- 1 – Rescue (or ambulance)
- 1 – Shift Commander
- 1 – CXX19

FIRST ALARM URBAN-INTERFACE:

- 8 – Engines
- 2 – Ladders
- 5 – Brush Trucks
- 4 – Tenders
- 2 – Rescues (or ambulance)
- 3 – Command Officers
- 2 – Shift Commanders
- 1 - CRV
- 1 - Safety Officer

**PHOENIX REGIONAL
STANDARD OPERATING PROCEDURES**

URBAN-INTERFACE DEPLOYMENT

M.P. 202.15B

04/20-N

Page 2 of 2

- 1 - Rehab
- 1 – CXX19

OPERATIONAL INFORMATION

Some Fire Departments within the CALSSRC staff Brush Trucks with a 4-person crew including a Company Officer. For the purposes of deployment, these Units shall have the designation of Brush Engine in the CAD system. A Brush Engine may be assigned by the Incident Commander to assume the responsibilities of Sector Officer (like any other Fire Company).

A Brush Truck shall be considered as a tool, or a resource. A Brush Truck is not staffed with a 4-person crew and must be assigned to a Company Officer (or Sector Officer). Brush Trucks shall not be assigned to positions on the fireground where they're unsupervised and/or unsupported.

**PHOENIX REGIONAL
STANDARD OPERATING PROCEDURES**

RED FLAG WARNINGS

M.P. 202.15C

04/20-N

Page 1 of 2

PURPOSE

The purpose of this procedure is to develop standard actions and considerations when a Red Flag Warning is issued.

DEFINITIONS

A Red Flag Warning is issued by the National Weather Service for weather events which may result in extreme fire behavior that will occur within 24 hours. A Red Flag Warning is the highest level of weather-related fire warning. A Red Flag Warning will normally be issued for severe fire weather events less than 12 hours in the future. The area affected, onset time, and a statement describing the conditions will be included in the forecast. Thresholds for Red Flag Warnings vary based on vegetation type, topography and other factors, but in the Phoenix area they are generally Sustained winds ≥ 20 mph and relative humidity $\leq 20\%$, scattered thunderstorms, increased thunderstorm activity after a prolonged dry period, abrupt change in wind speed and direction that may affect the area.

POLICY

When the Phoenix Fire Department Regional Dispatch Center (PFDRDC) receives notification of a Red Flag Warning they should notify all on-duty units via an MCT message. If a Red Flag Warning extends from one shift into the next shift, the MCT message should be repeated at 0800 immediately following shift change to notify the new on-duty crews. The message from PFDRDC to on-duty crews should include the standard Red Flag Warning details:

- *Affected Area:* This may include counties, cities or fire weather zones
- *Wind:* Speed and direction
- *Timing:* The hours the Red Flag Warning will be in effect
- *Relative Humidity:* Fine fuels found in the Phoenix area such as grass and bushes are particularly susceptible to fire when humidity is low
- *Other:* Include any additional pertinent information provided by the National Weather Service

An all-call on channel one will also be made to all stations that there is a Red Flag Warning in effect. This warning should be issued when the Red Flag Warning comes into the PFDRDC and repeated at 0830 for each shift the warning is in effect.

OPERATIONAL CONSIDERATIONS

Wildland Urban Interface: In Wildland Firefighting, a Red Flag Warning represents the highest probability of a wildfire occurring. The warning also indicates a significant danger to firefighters when operating on a wildfire incident. Red Flag conditions such as sustained winds >20 mph, abrupt wind speed and direction changes and low relative humidity combine to create a very dynamic and dangerous incident. During a Red Flag Warning, Company Officers should ensure that each crew establishes lookouts, communications, escape routes and safety zones (LCES) prior to exiting the vehicle to begin operations. Weather and wind conditions should be communicated to all crew members frequently. Any direct fire attack during a Red Flag Warning should occur from the burned side of the fire. Command officers should be pessimistic in their evaluation of potential cut-offs and fire breaks. Wildfires are extremely difficult to control during Red Flag conditions and have a high

**PHOENIX REGIONAL
STANDARD OPERATING PROCEDURES**

RED FLAG WARNINGS

M.P. 202.15C

04/20-N

Page 2 of 2

probability of spreading. Outside aid from state, tribal and federal resources should be considered early in the incident.

Structural Firefighting: A Red Flag Warning represents the same extreme danger during structural firefighting incidents as the danger in the wildland. Wind driven fires have led to firefighter injuries and fatalities across the United States. According to the National Institute of Standards and Technology (NIST), wind speeds as little as 10 miles per hour can cause rapid fire progression in a structure regardless of the structure type (houses, apartments, high-rise, etc.). When sizing-up the incident, all members should pay particular attention to wind direction and attack the fire from the windward side when possible. Opening any door on the leeward side of the fire will create a flow path and cause the fire to grow. Disciplined door control will help to alleviate the potential for firefighters being caught in a flow path. Transitional attacks from the windward side are very effective at cooling the interior prior to entry. All crews should closely coordinate any ventilation including windows, doors or vertical ventilation.

**PHOENIX REGIONAL
STANDARD OPERATING PROCEDURES**

CAR FIRES

M.P. 202.16

06/97-R

Page 1 of 2

This procedure identifies operational tactics for safe handling of motor vehicle fires.

FIRE CONTROL OPERATIONS

The minimum level of protection for fire fighters is full protective clothing breathing air from their SCBA. Captains must wear full protective clothing in order to directly supervise crews.

The minimum size of hoseline is the 1-1/2" handline.

APPARATUS PLACEMENT

Apparatus should be placed upwind and uphill of the incident if possible. This is to afford protection from hazardous liquids and vapors and reduces smoke in the work area.

Consideration must be given to using the apparatus as a barrier, to shield the incident scene from traffic hazards. Warning lights should be left operating, in conjunction with the use of traffic cones where needed. The use of flares by fire and police should be used with caution; consider the potential for flammable liquids and vapors.

Additional consideration should be given to positioning the apparatus at an angle to better allow the removal of any hose from the preconnect cross-lay compartments.

WATER SUPPLY

If the water carried on the responding apparatus will not be sufficient, early considerations must be given to additional water supply sources. A supply line or other engines/tenders may be required. Ladder companies may be used as an improvised standpipe at incidents on elevated freeways or parking garages.

FIRE ATTACK

A working fire involving the interior of the vehicle passenger compartment will damage the vehicle beyond repair. As such, the attack plan should consider the vehicle as a "write off" and a safe and appropriate approach and fire attack must be implemented.

Where patients are trapped in the vehicle, first water should be applied to protect the patients and permit rescue.

When rescue is not a factor, first water should be applied for several seconds to extinguish fire or cool down the area around any fuel tanks or fuel systems. This is especially important if the fuel tanks are Liquidified Petroleum Gas (LPG) or Liquid Natural Gas (LNG).

At least one member of the attack team must have forcible entry tools in his/her possession to provide prompt, and safe entry into the vehicle.

**PHOENIX REGIONAL
STANDARD OPERATING PROCEDURES**

CAR FIRES

M.P. 202.16

06/97-R

Page 2 of 2

HAZARDS AND SAFETY CONSIDERATIONS

- Liquid Petroleum Gas (LPG) and Liquid Natural Gas (LNG) are becoming common place as fuel for vehicles. Pressure release devices can create a lengthy "blow torch" effect, or should the pressure relief device fail, a BLEVE may occur. Vehicles may not be marked to identify this fuel hazard. If there is flame impingement on a visible LPG/LNG storage tank, take action to control the fire and cool the tank.
- If vapors escaping from the storage tank relief valve have ignited, allow the LPG/LNG to burn while protecting exposures and cooling the tank. Flow of gas through piping can be controlled by shutting off the valve at the storage tank.
- Energy Absorbing Bumpers--Consist of gas and fluid filled cylinders that, when heated during a fire, will develop high pressures which may result in the sudden release of the bumper assembly. This could result in serious injury to anyone in its path. Bumper assemblies have been known to travel 25 feet.
- Batteries--Explosion hazard due to presence of hydrogen vapors. Avoid contact with battery acid. When the situation is stable, disconnect battery cables (ground cable first).
- Combustible Metals--Some vehicles have various parts made of combustible metals, such as engine blocks, heads, wheels, etc. When these metals are burning, attempts to extinguish them with water will usually add to the intensity of the fire. Large quantities of water, however, will cool the metal below its ignition temperature. After some initial intensification, the fire should go out. Dry chemical extinguishers can also be effective.
- Trunk/Rear Hatch/Engine Hoods--Hold-open devices may employ, along or in any combination with any of the following: springs, gas cylinders, extending arms, etc. When gas cylinders are exposed to heat, failure or rupture of these devices should be expected. Excessive pressure may develop in lift assists causing a trunk, hatch or hood to fly open with explosive force when the latch mechanism is released. To insure personal safety, be sure to allow sufficient clearance when releasing latches.
- Fires involving the trunk/cargo area should be approached with extreme caution. Contents may include toxic, flammable or other hazardous materials. Expect the worst!
- Fuel Tanks--May be constructed of sheet metal or plastic. A rupture or burn-through may occur with these tanks causing a rapid flash fire of the fuel. Do not remove gas cap, as tank may have become pressurized. Do not direct hose stream into tank, as this will cause pressurization of tank, with a possible result of burning fuel spewing from the tank fill opening.
- Interior--Well sealed interiors of modern vehicles present the potential for backdraft. Use caution when opening doors or breaking windows. Appropriate approach, ventilation, and safety concerns must be considered. Have a charged handline ready before making entry
- Vehicle Stability--Tires or split rims exposed to fire may explode, causing the vehicle to drop suddenly. Expect exploding rim parts or tire debris to be expelled outward from the sides. Approach from the front or rear of the vehicle for maximum protection from potential flying debris. Some larger vehicles, such as buses, employ an air suspension system. When these systems are exposed to heat or flame, they may fail, causing the vehicle to SUDDENLY drop several inches.

**PHOENIX REGIONAL
STANDARD OPERATING PROCEDURES**

AIRCRAFT EMERGENCIES

M.P. 202.17

12/12-R

Page 1 of 3

PURPOSE

The purpose of this procedure is to establish guidelines for the response of Fire Department personnel and equipment to aircraft emergency situations. The procedure outlines responsibilities for an on-airport **and** off-airport Fire personnel. It identifies and defines the alarm terminology, airport alert response, airport staging areas, Aircraft Rescue and Fire Fighting (ARFF) standby locations, general aircraft fire fighting information, and the communication requirements.

GENERAL AVIATION FIRE FIGHTING RESPONSE PLAN

Since an aircraft crash can occur anywhere in the metropolitan area, off-airport units need to be informed of some basic tactical information and guidelines when dealing with aircraft crash incidents.

There are two types of aircraft crashes:

1. High Impact
2. Low Impact

TACTICAL BENCHMARKS

Below listed are tactical benchmarks to consider for any type of aircraft accident.

1. The first arriving unit should assume command and determine if the flight crew has initiated emergency evacuation procedures. Fire Department personnel should make every effort to prevent an unnecessary evacuation by immediately contacting the flight crew and reporting exterior conditions to them.
2. If emergency evacuation is in progress, assist evacuation of passengers and/or provide them a path of egress, by discharging **Class B foam only**, from apparatus. Create a path through the burning flammable liquid from the escape exit door to a safe area. If **Class B foam** is not available, use large volumes of water. Protect the aircraft fuselage from direct flame impingement since fire can burn through fuselage within 60 seconds. Ensure your own supply line. Master stream appliances (Stang Guns) utilizing fog patterns; provide quick water in large volumes to protect passengers during evacuation.
3. Deploy an attack line to the aircraft's interior, without inhibiting passenger egress. Fire intensity will require the use of 1-3/4" or 2" hand-lines, utilizing fog patterns.
4. Provide interior ventilation as soon as possible inside the aircraft. Fatalities in survivable aircraft crashes are usually due to smoke inhalation. Use wide angle fog patterns from hand-lines to ventilate. Positive Pressure Ventilation (PPV) is beneficial, however may not be initially expedient. Pressurize from unburned area and provide ventilation exit in fire area. Ventilation should be started at the same time as the attack lines are put into operation, if possible.
5. Aircraft have common attic spaces, large open cargo areas (in belly), and sidewalls that can have running fires in these confined spaces. Consider using penetrating nozzles to reach fire in confined spaces or any location where interior attack lines cannot be deployed.

**PHOENIX REGIONAL
STANDARD OPERATING PROCEDURES**

AIRCRAFT EMERGENCIES

M.P. 202.17

12/12-R

Page 2 of 3

6. Use ladders at the aircraft at the wing or other accessible points. Some aircraft may require aerial ladders to reach access points.
7. Obtain primary and secondary all clears. Never assume absence of survivors.
8. Provide for interior lighting.
9. Request Police Department secures the scene and provides a holding area to assist in the control of the ambulatory passengers.
10. Establish both fire and medical sectors as soon as possible. Designate sectors for both sides of the aircraft to protect the escape routes and manage the evacuated passengers. Assign sectors to address scene lighting, extrication, treatment, transportation and site safety.
11. Consider establishing a branch level command system to address Fire and Medical Operations separately.
12. Ensure necessary amounts of foam extinguishing agents to amounts of flammable liquids on fire.
13. Maintain effective foam blanket to prevent ignition / re-ignition of fuel.
14. Maintain awareness of electricity generated by large aircraft, aircraft generate sufficient electrical and hydraulic energy to seriously injure personnel and/or ignite fuel sources.
15. Jagged metal from aircraft can cut through protective clothing and hose lines.
16. To gain access into the fuselage, use the wing area or a platform ladder truck to work from. The optimum place to cut is around windows and roof area. Hydraulic powered tools (Hurst, Holmatro, etc.) and pry bars do not work well on aircraft metals due to the lack of solid supports to work against.
17. If saws are used for extrication or ventilation, arcing and sparking will need to be suppressed with water/foam from hand lines. Maintain integrity of foam blanket on flammable liquids. Be aware that aircraft have numerous high pressure hydraulic lines that operate at 3000 psi; these can cause serious injury if cut or broken under pressure.
18. Ensure back-up crew/s with charged hose lines in place to protect all personnel who will be working inside the spilled flammable liquid areas. All personnel working in these areas shall be fully turned out with protective gear and S.C.B.A. face piece on.
19. Have police secure a route of ingress / egress, to permit emergency equipment, particularly ambulances, unimpeded movement to / from the incident.
20. Do not allow any overhaul operations to take place until all investigative agencies are finished or unless needed to rescue victims or suppress fire.

**PHOENIX REGIONAL
STANDARD OPERATING PROCEDURES**

AIRCRAFT EMERGENCIES

M.P. 202.17

12/12-R

Page 3 of 3

21. Large aircraft have oxygen cylinders on board that can explode, become missiles, and/or accelerate the spread of fire.
22. Adopt a defensive mode of operation, as needed, to protect personnel and exposures.
23. Request the Alarm Room notify the National Transportation Safety Board (NTSB). Notification can be made contacting the FAA Air Traffic Control Tower at Sky Harbor Airport or by calling Sky Harbor Communications at 273-3311.
24. Request the Alarm Room notify area hospitals, Salvation Army, Red Cross, County Emergency Disaster Coordinator, C.I.D. Team and Sky Harbor Communication Center.
25. For off airport responses consider requesting ARFF foam trucks, Medical Support 19 or Foam 34 or 54, if they have not been dispatched. Off airport ARFF response from Sky Harbor has a 5 mile radius. Any other request for Sky Harbor Foam Trucks for off-airport response should be coordinated through BC19 or District 19 Chief. The airport must maintain an index of 3 foam trucks at all times.
26. Have an airline representative report to the Command Post along with the District 19 Chief, liaison from the Aviation Department, and any other agency that can assist with the incident.

**PHOENIX REGIONAL
STANDARD OPERATING PROCEDURES**

High Piled Outside Combustible Storage Fires

M.P. 202.18

04/18

Page 1 of 4

Purpose

The purpose of this procedure is to establish guidelines for companies operating on fire incidents involving high piled outside combustible storage. High piled outside combustible storage fires are defined as outside fire incidents including but not limited to:

- Pallet Storage
- Metal Recycling
- Tire Storage (See Tire Fires MP 202.18A)
- Paper Stock
- Mulching Operations
- Wrecking Yards
- Lumber Yards
- Large unfinished construction projects (stick cities)
- Any other fires incident involving outside combustible storage

In These Incidents, The Tactical Objectives Are:

1. Firefighter Safety
2. Exposure Protection
3. Environmental Protection (including public health)
4. Fire Control

Procedures

1. Size up the incident and identify critical fireground factors
 - A. Forecast how quickly the incident will escalate
 - B. Identify material burning and path of fire spread
 - C. Look at aerial photos
 - D. Consider initial single company sector for reconnaissance
2. Employ the Risk Management System to determine and announce an appropriate strategy (likely defensive)
3. Establish and maintain an appropriate Incident Command System
4. Build and communicate your Incident Action Plan
 - A. Water supply is critical (pumped water/reversing off forward pumper, relay operations, drafting operations)
5. Build an incident organization to achieve tactical objectives
 - A. Sectorize early (2&1 to most critical sector)
 - B. Consider geographical sectors in order of priority
6. Evaluate resource requirements
 - A. First alarm for defensive operations should cover 2 geographical sectors (consider additional resources)

High Piled Outside Combustible Storage Fires

M.P. 202.18

04/18

Page 2 of 4

Operational Information

High piled outside combustible storage incidents can be as dangerous to firefighters as structural fire incidents. Each incident has its own unique challenges for our service delivery as well as managing firefighter safety. It is imperative that our incident command system utilize the same strategic decision-making model for high piled outside combustible storage incidents as it does for structural fire incidents.

The standard decision-making model includes:

1. The identification of the incident's critical fireground factors
2. Selection of the appropriate risk management plan
3. Identification of strategy
4. Development of an Incident Action Plan (IAP)
5. Identification and completion of the incidents tactical objectives.

This process is ongoing and continual, which requires a review/revision based on actions and conditions until the tactical objectives are met.

1. Critical Factors

Identifying the critical factors while responding to and arriving on any incident scene is imperative to a successful outcome. The size up for high piled outside combustible storage incidents should include:

- Incident location
- Type and amount of material burning
- Fire growth potential
- Exposures
- Water supply (hydrants, drafting, tankers)
- Fire apparatus access
- Hazards (hazardous materials storage tanks, power lines, underground gas, railroad tracks, rail cars, etc)
- Environmental impact
- Resources required for incident mitigation (including sustaining incident operations as well as system wide response and resource considerations)

The initial dispatch information is rarely complete. These situations can evolve rapidly, and it is necessary to assume that the information, which is initially received, will change. It is important to approach these incidents slowly and cautiously. High piled outside combustible storage fires may grow quickly. Over-committing prior to fully evaluating the critical factors can pose significant danger to firefighters, as well as unnecessary damage to apparatus and equipment.

**PHOENIX REGIONAL
STANDARD OPERATING PROCEDURES**

High Piled Outside Combustible Storage Fires

M.P. 202.18

04/18

Page 3 of 4

The success of any fire suppression operation begins at the company level. The Company Officer should familiarize his/her crew with all high piled outside combustible storage facilities located within their area of response. Information gathered should be entered into the CAD system for the specific locations allowing easy access on the MCT during response and for pre-incident planning in the station.

2. Risk Management System

It is critical that all hazard zone decisions are based on the application of the Risk Management System.

This application will be continuously re-assessed throughout the incident.

- We will risk our lives a lot, in a calculated manner, to save SAVABLE lives.
- We will risk our lives a little, in a calculated manner, to save SAVABLE property.
- We will not risk our lives at all for lives or property that are already lost.

“Actions in a calculated manner” require the following:

- Incident Command established (where applicable, refer to M.P. 201.01)
- Proper personal protective equipment
- Accountability system established (where applicable, refer to M.P. 201.03)
- Safety procedures in place
- Continuous risk assessment by all members

The use of this Risk Management System will improve the incident commander’s ability to provide a more predictable, safe environment to achieve the tactical objectives. Fires involving high piled outside combustible storage often burn and extend quickly. We will not risk our lives at all for property that is already lost. All firefighters operating on these types of incidents should employ a pessimistic application of the Risk Management System which includes realistic forecasting.

3. Strategy

Strategy defines the operational posture of the incident. We are either operating in an offensive or defensive strategy. An offensive strategy aimed at rescuing victims is unlikely in a high piled outside combustible storage fire. More likely are offensive operations to save property; however, there is typically a very small window in which offensive attacks could be successful. Forecast how much the fire will grow, and in most cases, a defensive operation is appropriate. Incident Commanders need to make sure all personnel operating on the incident are aware of the strategy. Regardless of strategy, the first priority is firefighter safety, and there is no reason to endanger firefighters during defensive operations.

High Piled Outside Combustible Storage Fires

M.P. 202.18

04/18

Page 4 of 4

4. Incident Action Plan

High piled outside combustible storage fires have the potential to be large scale incidents. The incident action plan must be safe, well communicated and consistently evaluated against the conditions and the effectiveness of the actions being taken. The incident action plan should always match the strategy.

- *Offensive High Piled Outside Combustible Storage Fire Incident Action Plan:* Quick aggressive rescue, quick aggressive fire attack to stop the fire spread early, providing for firefighter safety, and a continuous water supply throughout. Once rescue operations are completed, pessimistic evaluation and forecasting of risk vs. gain will be applied to offensive operations to save property.
- *Defensive high piled outside combustible storage fire incident action plan:* Provide for firefighter safety, identify main body of fire and paths for extension through pessimistic forecasting, address exposures including public health, address environmental protection, and extinguish fire using master streams, if appropriate.

5. Tactical Objectives

- *Firefighter Safety:* Awareness of the hazards involved in high pile outside combustible storage fire can be the best personnel protection. Firefighter safety is our top priority. Rapid fire spread, toxic exposure, fatigue, heavy equipment, fire apparatus, and master streams are some of the unique hazards on these incidents.
- *Exposure Protection:* High piled outside combustible storage fires have a potential to grow rapidly and threaten structural exposures and public health. Incident Commanders should establish sectors early to protect exposures and evacuate if necessary.
- *Environmental Protection (including public health):* There are many considerations associated with environmental protection and public health on high piled outside combustible storage fires. Incident Commanders need to give careful consideration regarding the material burning, and the consequences of letting the material burn vs. fire suppression with big water. Hazmat units and environmental specialists like the Arizona Department of Environmental Quality can assist Command with evaluation of environmental protection and public health on these incidents.
- *Fire Control:* Depending on the nature of the incident, fire control may be addressed in a variety of ways. For example, fire suppression with big-water, removing fuel from the fire with heavy equipment, and letting the fire burn itself out are all acceptable considerations for fire control. Emphasis should be placed on potential for fire spread and exposure protection. Clean-up will likely be turned over to an appropriate environmental protection agency.

**PHOENIX REGIONAL
STANDARD OPERATING PROCEDURES**

Tire Fires

M.P. 202.18A

05/18

Page 1 of 8

Overview

Tire fires present the same potential threat to the environment that an incident involving an oil tanker or a railroad tank car carrying hazardous substances. The average passenger car tire holds 2.5 gallons of oil. When exposed to extreme heat, the tires reach a state of combustion where volumes of pyrolytic oil can be produced. This could turn the tire pile into a running oil fire. Exposure hazards associated with the smoke plume, water runoff, and soil include:

- Volatile organic chemicals
- Polynuclear aromatic hydrocarbons
- Carbon monoxide
- Heavy metals

These toxins can be absorbed either through the skin, mucus membranes or respiratory system.

The success of any fire suppression operation begins at the company level. The Company Officer should familiarize his/her crew with all scrap tire piles located within their area of response. Information gathered should be entered into the CAD system

Areas of consideration during pre-planning should include:

- Site location
- Type of operation
 - Salvage or recycling
 - Managed or unmanaged
- Tire piles composition (e.g., whole, burned, shredded, random stack, etc.)
- Tire pile size
- Available equipment (e.g., backhoes, front-loaders, etc.)
- Hazards
- Exposures (e.g., storm drains and dry wells if applicable)
- Utilities (e.g., overhead wires, underground gas lines, communication equipment, etc.)
- Response conditions
- Geographical information
- Topography (e.g., to include possible runoff containment locations)
- Emergency contacts

**PHOENIX REGIONAL
STANDARD OPERATING PROCEDURES**

Tire Fires

M.P. 202.18A

05/18

Page 2 of 8

Deployment Considerations

It is recommended that major tire fires be handled as hazardous materials incidents. The incident taker will obtain all available information from the caller to determine what is on fire. A hazardous 3-1 will be dispatched if it is determined that a tire pile is on fire.

Size-Up

Upon arrival the Company Officer must determine the stage of combustion:

1. Incipient
2. Free burning
3. Smoldering

The incipient stage of a tire fire begins with a point of ignition. Once a tire has gained an open flame front, the heat of the fire is absorbed by the surrounding tire material. Immediately separating the burning tire from the rest of the pile and/or applying water and foam would eliminate the threat to the remaining tires.

During the free burning stage, fire spreads quickly and there is a dramatic increase in smoke and heat. Use of water in this stage of a tire fire could increase the products of incomplete combustion like carbon monoxide and particulate matter. The cooled tires may continue to pyrolyze, producing large quantities of oil. A crust may form over the pile while internal temperatures reach about 2,000 degrees Fahrenheit. The smoldering stage has begun.

Oil not consumed by the fire will leach into the soil, pool, and begin to flow under the pile. Heat from the fire could ignite the oil, resulting in a three-dimensional fire. Products of incomplete combustion continue to be a health hazard.

During the initial size-up, the Company Officer has to determine if the fire can be extinguished quickly without endangering personnel. If the fire is in the free burning or smoldering stage the most immediate concern will be the life safety of Firefighters and the community. Approach to the incident should be in accordance with tactics common to other potential hazardous materials incidents.

**PHOENIX REGIONAL
STANDARD OPERATING PROCEDURES**

Tire Fires

M.P. 202.18A

05/18

Page 3 of 8

Initial size-up should include the evaluation of the emergency in terms of:

- Personnel safety
- Public health
- Environmental impact
- Threatened exposures
- Extent of fire
- Need for additional resources

Personnel Safety

Awareness of the hazards involved in a tire fire can be the best personnel protection. Heat exhaustion and working in less than ideal conditions is a reality in a large tire fire. Command will want to prepare for total exposures, health hazards and personal injury hazards.

Full turnout gear is the minimum level of protection required for everyone working the tire fire.

1. Boots
2. Turnout pants
3. Turnout coat
4. Gloves
5. Helmet
6. Nomex hood
7. S.C.B.A. with Mask

NOTE: Conditions permitting E.M.S. gloves under the leather gloves will give added protection from contact with the contaminated water, oil, and mud.

The risk of exposure to toxic chemicals continues after the fire is out. Smoldering tires are as toxic as tires in a free burning state. Flying ash and contaminated soil are also potential hazards. The temptation to dress down for overhaul should be resisted until the hazardous materials team has determined the appropriate level of protective clothing required.

Command will establish a Lobby Sector to ensure personnel accountability. When multiple points of entry to the incident exist, geographic sectors should be established (e.g., lobby north, lobby east, etc.). Hazard sectors, zones and Rehab Sector will be established according to the Standard Operating Procedures.

The Incident Commander will establish a Decontamination Sector for all personnel leaving the

**PHOENIX REGIONAL
STANDARD OPERATING PROCEDURES**

Tire Fires

M.P. 202.18A

05/18

Page 4 of 8

fire area. All protective clothing, firefighting equipment and apparatus will need to be decontaminated as well.

Sectors such as environmental, safety, PIO and any other sectors/branches listed under "Command Concerns" in this procedure will be established as the incident progresses.

Personnel must be aware of other hazards involving scrap tire fires. Contact with rodents, mosquitoes, snakes, spiders and scorpions will be reduced with protective clothing.

Be aware of the dangers of machinery and heavy equipment operating on the fire scene. Collapsing walls of tires can block escape routes or cut off water supplies.

Public Health

Command should determine early whether to evacuate the surrounding areas. Tire fires are extremely difficult to extinguish. Given this knowledge, no strategy for managing the incident should bypass evacuation considerations.

Evacuation Sector should be established early. The process will be managed according to the Evacuation Sector procedure (M.P. 201.05E).

Environmental Impact

Command should size-up the potential environmental consequences of the fire and begin notifying the appropriate agencies. Emergency contacts can be notified according to the Environmental Sector procedure (M.P. 201.05D). Early notification will facilitate their timely placement into the Command structure and involvement in the incident.

Areas of concern will include:

**PHOENIX REGIONAL
STANDARD OPERATING PROCEDURES**

Tire Fires

M.P. 202.18A

05/18

Page 5 of 8

- Life safety
- Proximity of wildlands
- Potential toxic run-off
- Bodies of water
- Smoke plume
- Wind direction/speed

Tactics

Important tactical considerations include:

- Life safety
- Protecting exposures
- Isolating burning tires
- Use of heavy equipment
- Overhead or underground utilities

Immediate evacuation of the incident scene is a high priority. Every effort should address life safety of the incident scene. Protection of the fire crews safety will be addressed continuously. On-deck crews will be established according to the In-Transit, On Deck, Company Recycle procedure (M.P. 201.01A). Buildings, equipment and utilities in the proximity of the fire will need to be protected. Command needs to determine the amount of fuel actively burning and the total amount of fuel available. Estimate the rate of spread to determine what will be allowed to burn and where fire breaks will be cut through the pile.

Creating fire breaks in a large tire pile is a long and time consuming process. It can be accomplished with heavy machinery and front-end loaders. Use of City Equipment at Emergency Scenes procedure will allow Command to implement the process (M.P. 206.15).

Strategy

**PHOENIX REGIONAL
STANDARD OPERATING PROCEDURES**

Tire Fires

M.P. 202.18A

05/18

Page 6 of 8

Successful options for fighting a tire fire have been employed individually and in many cases, in combination with one another. Reduced to the lowest common denominator, these options are:

1. Burn it
2. Bury it
3. Drown it

Burn It

Letting a tire pile burn has its merits. Soil and water pollution may be drastically reduced when many of the products of combustion go up in smoke. The clean up costs can be reduced when compared to other options.

A precedent for the burn it strategy appears in fire responses to chemical fires. Adding water to fires or hazardous materials which react to water could exacerbate the emergency.

Importantly, the fire service must manage and control the burn. Protecting exposures and separating tires from the burn area will continue to be a tactical priority.

Bury It

The decision to bury a tire pile also has merits. Sand, cement dust, quick lime, and crushed coral rock are all high in calcium content. Calcium scrubs sulfur from the emissions, creating calcium sulfate or gypsum.

The bury it strategy could be employed in areas that have minimal water supply or in areas that are densely populated. The decision to bury a tire fire would take into consideration reducing toxic smoke for the sake of public health.

Geological considerations play an important role in the bury it strategy. While the tire fire is entombed, fires can still pyrolyze and push toxic oil into the soil and underground water sources. Burying a tire fire that is on top of clay soils may delay the oil from filtering to underground water supplies. To determine the release of pyrolytic oil, check down gradient from the pile for contamination.

Drown It

**PHOENIX REGIONAL
STANDARD OPERATING PROCEDURES**

Tire Fires

M.P. 202.18A

05/18

Page 7 of 8

Water, foam, and additives have their own place as an option. The drown it strategy is best employed with forethought and careful pre-planning. Knowing in advance the topography and exposure hazards to water sources will be critical.

Drawbacks to the drown it strategy include:

- An increase in the toxic air emissions as the fire is cooled causing the combustion process to slow down.
- An inordinate amount of water run-off combined with pyrolytic oil will be the result of trying to drown out a fire.
- Effectiveness of working lines applied to a tire fire is questionable. Handlines alone cannot reach the interior spaces of a tire fire.

The use of working lines on chunk and chipped tires, however, can be effective when used in a fog application. Here again, separating the inventory from the burn area is important to the control and extinguishment of chipped and chunk tire materials.

The use of foam would best be employed on small tire fires or when the fire is in the incipient stage. Pulling a larger tire pile apart with heavy machinery and applying foam would be a prudent use of the product. Foam should only be employed as part of a predetermined strategy.

Clean-Up and Overhaul

Unlike traditional structural fires or wildland fires, clean-up on tire fires will; in all probability, be turned over to an appropriate environmental protection agency. Hazards to personnel exist long after the fire is out. Toxicity levels of tire fire sites suggest high concentrations of contaminants. Flying ash and contaminated soil blown around the site may increase your exposure risks.

**PHOENIX REGIONAL
STANDARD OPERATING PROCEDURES**

Tire Fires

M.P. 202.18A

05/18

Page 8 of 8

Command Concerns

Scrap tire fires can potentially last days, weeks, or months. Combined with the fact they are highly toxic and dangerous, Command must consider or address the following concerns:

Emergency Operations Center

Lobby Sector

Police Liaison

Emergency Operations Plan

Environmental Sector & ADEQ

Resource Sector

Accountability

Evacuation Sector

Rehabilitation Sector

On-Deck

Public Information Sector

Staging Sector

Safety Sector

Welfare Sector

Hazardous Materials Sector

Air Operations

Decontamination Sector

Evacuation Sector

Water Department
Communications

Mutual Aid Response

Code Enforcement & C99

**PHOENIX REGIONAL
STANDARD OPERATING PROCEDURES**

Mulch/Compost Fires

M.P. 202.18B

04/18

Page 1 of 2

Purpose

The purpose of this procedure is to establish guidelines for companies operating on incidents involving mulch/compost fires. Mulch/compost fires pose a unique challenge for fire companies due to the many different tactics needed to resolve these incidents.

Policy

The best practice to extinguish mulch/compost fires is to isolate the burning material by removing the surrounding uninvolved material, spread out the burning material and then apply water to only that material. Initial companies need to understand that these types of fires are going to be Defensive. Incident Commanders should take their time in developing a plan and realize that our standard quick, aggressive, offensive tactics will not work. Often application of water is actually the worst thing we can do and only makes the incident more difficult to control.

Procedure

The first arriving company will assume command and make access to the site (if necessary, relay best access to AHQ). All other companies should stage appropriately. The Incident Commander shall evaluate the Critical Fireground Factors, with an emphasis on determining if this is an isolated mulch/compost fire or are there structural exposures to protect. The following questions need to be asked during size up and when developing an Incident Action Plan:

- What type of fire and how large is it (i.e. small surface fire vs. deep seated fire)?
- Are there exposures in immediate danger?
- How far has the fire progressed?
- What direction is the fire going, and what is the wind direction?
- Is there heavy equipment and qualified operators on site (e.g. loaders, dozers, etc.)?
- What are the water supply options (e.g. hydrants, daisy-chains, drafting, tankers, etc.)?
- What is the availability of additional resources and special equipment?

**PHOENIX REGIONAL
STANDARD OPERATING PROCEDURES**

Mulch/Compost Fires

M.P. 202.18B

04/18

Page 2 of 2

With Structural Exposure

For any fire larger than a small surface fire that the initial arriving unit cannot resolve, the Incident Action Plan should be primarily determined by the presence of any immediate exposures. If exposures exist, the Incident Commander should develop an Incident Action Plan with a priority on exposure protection that accomplishes the following:

1. Location of a site manager or responsible party
2. Secure an uninterrupted water supply as needed
3. Assign companies to key positions to protect exposures (assigned companies need to be aware of ground conditions and position apparatus appropriately)
4. Identification of an appropriate incident organization and sectors as needed
5. Only apply water as needed to protect exposures
6. Develop a plan to extinguish the burning mulch/compost
7. Request appropriate resources (e.g. Foam-Truck, Hose-Truck, Car99, ADEQ, RM50, PIO, etc.)

Without Structural Exposure

If no exposures exist, the Incident Commander should develop an Incident Action Plan that accomplishes the following:

1. Locate a site manager or responsible party
2. Secure an uninterrupted water supply as needed
3. Do not apply water to main pile of burning material, wait until pile is isolated
4. Develop a plan to isolate burning material using on-site equipment, Car 99, etc.
5. Assign companies to key positions that allow for application of water to isolated material (be aware of ground conditions when assigning units)
6. Identification of an appropriate incident organization and sectors as needed
7. Request appropriate resources (e.g. Foam-Truck, Hose-Truck, Car99, ADEQ, RM50, PIO, etc.)

Operational Information

Fires in composting facilities are relatively common; fortunately, most facilities are able to resolve small surface fires. Fires are started in one of two ways, internal combustion caused by the breakdown of the organic materials or external ignition (lighting, sparks, smoking materials and arson). Deep seated smoldering fires can actually burn for days before being detected. These are the types of fires our fire companies typically will encounter.

**PHOENIX REGIONAL
STANDARD OPERATING PROCEDURES**

C99 CAPABILITY AND FUNCTION

M.P. 202.19

11/19-N

Page 1 of 2

C99 is a response apparatus housed at Fire Prevention within the Phoenix Fire Department. It is staffed by Deputy Fire Marshals that rotate on an A-B-C schedule to compliment the Fire Operations schedule. C99 assists Fire Operations crews by remaining on scene of certain incidents in order to allow the crews to return to service. C99 then contacts the property owners and responsible parties in order to coordinate a resolution to the incident and legally transfer liability and risk back to the property owner or responsible party through documentation. C99 is typically only dispatched at the discretion of the Company or Command Officer managing the incident. Incidents that C99 can respond to are as follows:

SPRINKLER/ SUPPRESSION/ FIRE ALARM/ KITCHEN HOOD ANSUL / CO2 ACTIVATIONS OR DAMAGE TO THESE SYSTEMS RENDERING THEM INOPERABLE

- Verify these systems have required life safety features and are installed correctly while operating as designed
- Damaged systems require immediate restoration by licensed fire protection professional. Systems that are unable to be restored to normal operating conditions will be documented and a fire watch will be required
- Frequent false alarms or malfunctions, when reported by Fire Operations, will be followed up and documented for correction
- Any CO2 alarm activation requires a C99 response. A false alarm or any leak will require an inspection of the entire system
- Any sprinkler activation requires a C99 response to ensure the system is put back in service

SPILLS/ LEAKS/ ILLEGAL DUMPING

- If on City of Phoenix property, (easements, parcels) C99 will coordinate with City officials and the Office of Environmental Programs to ensure the spill, leak or illegally dumped material is properly disposed of
- If on private property or streets, C99 will identify the property owner or responsible party and require them to contract with a qualified Hazardous Materials Cleanup contractor for proper cleanup and disposal of said material

SICK BUILDINGS

- In the event multiple patients complain of the same general illness symptoms or if a patient requires transport to the local emergency room from a suspected illness caused by the building
- C99 will evaluate the need for an industrial hygienist to investigate the building and assist in determination if building access should be restricted

STRUCTURAL INTEGRITY ISSUES

- Vehicles into buildings, collapse or any instance where the integrity of a structure is being called into question
- C99 will require the property owner or responsible party to contract with a structural engineer or private contractor to shore up the structure until repairs can be made
- C99 will document the unsafe building and contact the Planning and Development Department Structural Section for follow-up

**PHOENIX REGIONAL
STANDARD OPERATING PROCEDURES**

C99 CAPABILITY AND FUNCTION

M.P. 202.19

11/19-N

Page 2 of 2

ACCESS ISSUES

- When emergency response is inhibited or defects are discovered on gates, fences, fire doors, Knox Boxes by Fire Operations
- C99 will discuss with crew via phone to determine if issue needs to be immediately addressed or if Fire Prevention can follow-up during business hours.

OVERCROWDING

- C99 will respond to verify occupant load approved for the structure and ensure egress is accessible
- C99 will limit entry until occupant load is reduced to a safe number

DAMAGED POOL FENCES

- When there is 18" of water or greater in a pool with a damaged or missing pool fence
- Front yard pools without barrier or fence present
- C99 can create a temporary barrier to prevent a potential drowning
- C99 may contact the Neighborhood Services Department for follow-up

C99 is automatically dispatched on overcrowding and CO2 alarms.

**PHOENIX REGIONAL
STANDARD OPERATING PROCEDURES**

EMERGENCY ACCESS KEY USAGE AND FIRE ALARMS

M.P. 202.19A

11/19-N

Page 1 of 3

PURPOSE:

This procedure is intended to provide guidelines for usage of the high-security emergency access key and determination of a course of action when dealing with activated fire alarms.

POLICY:

If an emergency access device is present, fire companies should utilize that device to access the premises during emergency situations. Emergency access devices include: key boxes, preemption or opticom detectors, key switches, and fire department pad-locks.

When responding to fire alarm indications, fire companies should size up the situation; if a key box is present, fire companies should utilize the key box to access the property.

DEFINITIONS:

Emergency Access Keys are defined as those keys that allow access to buildings or equipment as required by the Fire Code.

False alarm is defined as any activation of an alarm system because of human, mechanical, lack of maintenance, negligent or electrical error.

PROCEDURE:

1. The first arriving unit shall do a size up to determine if a visible emergency exists (water, smoke, or flames visible).
 - a. Look for a red bell on the outside of the building. If the bell is ringing, water is very likely to be flowing out of the fire sprinkler system.
2. Formally establish command when appropriate (see M.P. 201.01 Command Procedures).
3. If a visible emergency situation exists, take appropriate actions for the type of occupancy involved.
4. If no visible emergency exists, request that the Alarm Room verify with the alarm company that a responsible party has been contacted and is responding.
5. Check the premise for a key box. If key box is present and has functional key inside, access the building.
 - a. If a key box is not present or functional keys to access the building are not provided, fire companies should determine if forcible entry is necessary based on size up. These decisions are made on a case-by-case basis and are founded on protecting property. The Fire Department will not be held liable for damages as a result of not forcing entry or forcing entry if a key box or functional keys are not provided.
 - b. Proceed to the Fire Alarm Control Panel to determine the status of the alarm system and indicate possible reasons for the fire alarm activation (alarm, trouble, or zone). Also, this will assist with identifying the location(s) of the alarm system device(s) that may be causing the alarm.

**PHOENIX REGIONAL
STANDARD OPERATING PROCEDURES**

EMERGENCY ACCESS KEY USAGE AND FIRE ALARMS

M.P. 202.19A

11/19-N

Page 2 of 3

6. While a systematic investigation of the premises is taking place to determine the device(s) that activated the system, the Fire Alarm Control Panel can be silenced if a switch exists to do so, but under no circumstance should the panel reset button be pushed at this time.
 - a. If water, smoke, or flames are found during the investigation take appropriate action for the occupancy involved.
7. If after the investigation has been completed and a determination of what caused the system to activate cannot be found, allow the alarm system to remain in silence mode until the emergency contact person responsible for the occupancy resets the system.
8. If it has been determined that a pull station was inadvertently activated and there are no other devices activated, firefighters may reset the pull station if possible and the alarm system.
9. If the emergency contact person is not responding or has extended ETA, firefighters may reset the system and go back in service. We cannot have fire companies unavailable on calls where no indication of an emergency exists.
 - a. The company officer should relay the alarm conditions to the building occupants if present.
10. False alarms should be recorded in the FIR system so that appropriate billing and follow up can occur. The company officer should complete all appropriate fields in the FIR and submit it within the same shift. False alarms should be categorized in one of the following four incident types:
 - a. Alarm system sounded due to malfunction
 - b. Smoke detector activation due to malfunction
 - c. Sprinkler activation due to malfunction
 - d. Extinguishing system activation due to malfunction
11. If at any time fire companies require assistance or if there was a fire protection system activation, contact C99 via the Alarm Room. An example of a fire protection system activation is a fire sprinkler flowing water in the building.

OPERATIONAL INFORMATION:

Selecting one of the incident types for false alarm reporting will automatically generate a report to the Phoenix Police Department Code Enforcement Unit (PDCEU). The Police Department handles all warning letters, billing and collections as outlined in the City of Phoenix Code. Standard residential smoke detectors that are not monitored by a third-party company are not subject to any fee but should still be reported with the above incident types for tracking and customer service follow-up.

Fire Prevention (FP) provides a follow-up inspection in occupancies that have had ten false alarms reported in any 365-day period. The notification to FP that an occupancy has had ten alarms is automatically generated when the appropriate incident type is recorded in the FIR system. Fire Prevention can provide in-person follow-up with the occupancy owner earlier if requested by the company officer by contacting Fire Prevention at (602) 262-6771.

**PHOENIX REGIONAL
STANDARD OPERATING PROCEDURES**

EMERGENCY ACCESS KEY USAGE AND FIRE ALARMS

M.P. 202.19A

11/19-N

Page 3 of 3

Smoke detector activation is typically indicated by a L.E.D. located on the smoke detector that remains constantly illuminated. In some cases, the L.E.D. flashes rapidly when the smoke detector is activated. Compare all smoke detector devices to assist in determining if the detector is activated or not.

Heat (thermal) detectors have no visible means of determining if they are activated.

Pull stations will typically have the activation lever pulled down or out to indicate activation. Some pull station devices that have glass rods will have the broken rod lying on the floor beneath the pull station.

PHOENIX REGIONAL STANDARD OPERATING PROCEDURES	
Policy Name: MID RISE OPERATIONS	Policy Number: M.P. 202.20
This policy is for internal use only and does not expand an employee’s legal duty or civil liability in any way. This policy should not be construed as creating a duty to act or a higher duty of care, with respect to third party civil claims against employees or the Phoenix Fire Department (PFD). Remedies for violations of this policy, if proven, are limited to administrative disciplinary action against PFD employees.	
Related Policies: 201.01A, 202.04, 202.05, 202.05C, 202.12E	
Other Reference:	
Date Implemented: 12/2021-N	Review Date: 12/2026

PURPOSE

The purpose of the procedure is to describe the unique operational considerations that mid-rise structures and occupancies pose for fire operations. These considerations are specific to these types of structures and differ from the more traditional apartment buildings/complexes as well as from high rise buildings. These considerations come in the form of construction materials and building practices, interior layout, fire protection systems, and building systems. These structures require specific operational attention for initial arriving companies in locating the fire, attacking the fire, and protecting and/or removing endangered occupants. These considerations present safety concerns that are specific to these buildings and challenge standard safety practices for other occupancy types.

Preplanning is critical for successful operations in these buildings. Because of the broad spectrum of construction practices, size, and configurations it is necessary to expect the unexpected.

As in any other structure, the ability of the Phoenix Fire Department to extinguish the fire as quickly as reasonably possible improves the conditions for any possible victims and the safety of the firefighters. All firefighting operations in mid-rise buildings should be built around this fact.

MID-RISE DEFINITION

For the purposes of Phoenix Regional Standard Operating Procedures, a mid-rise is defined as anything below 75’ in height and greater than 3 stories. The City of Phoenix currently has residential and commercial mid-rise buildings in our city and in our neighboring communities. Mid-rise structures have different fire protection system standards than high-rise structures. The mid-rise fire protection standards in the fire code are dependent on construction features and elements hence is not the same across all mid-rise buildings.

MID-RISE SIZE UP AND FIREGROUND FACTORS

Preplanned information and a thorough size up are critical to early success for fires in mid-rise buildings. There are many unique critical factors for mid-rise structures that impact fire attack, rescue operations, and firefighter safety. Early recognition of the fireground factors and appropriate action to limit the fire growth and the impact to victims is fundamental. The size up should include all means of rescue and access from the most advantageous position. Fire conditions should be assessed for the best position of a fire attack. Size up should also include the recognition of structural involvement as early as possible with a pessimistic perspective.

Size-up in mid-rise structures should begin with the standard, fundamental size-up questions, and drive to the recognition of the unique challenges presented at each individual incident.

The critical factors for mid-rise include but aren't limited to:

- Life Safety
 - Residential mid-rise structures can have high density occupancy
 - Rapid evaluation of removing the fire from the victims or the victims from the fire is critical and should not delay an effective fire attack
 - Commercial mid-rise occupancies should be evaluated for the presence of life safety and managed as an action of opportunity and should not delay an effective fire attack
 - Rescues may be required from exterior positions dependent on the conditions and the ability of victims to escape
 - Many mid-rises have roof top common spaces that have the potential for high population density at any given time

- Fire and Smoke Conditions
 - Nothing showing means nothing
 - It is likely to have a serious fire with no external signs on arrival
 - Ventilation limited conditions are a significant possibility due to tightly sealed buildings
 - Recognition of building openings are critical in measuring the flow path potential
 - Wind driven conditions are a distinct possibility of floors above ground level
 - Determination of smoke and fire conditions in common hallways and stairwells is critical in determining the life safety impact and difficulty of a fire attack

- Access
 - Mid-rise structures do not typically have lobby level, centralized entrance that provides access to the entire structure
 - Mid-rise structures typically have multiple entrance points for different geographical areas of the building

- Not all access points and stairwells will have standpipes or sprinkler control systems
- Evaluate the presence of exterior access points from balconies via aerial apparatus
- Floor access can come from multiple points
- The fire code does not require the availability of keys or key fobs for all areas of the structure
- The fire code requires keys be present for only these places:
 - Pools
 - Utility/Mechanical/Electrical rooms
 - Fire sprinkler riser room
 - Fire alarm control panel rooms
 - Stairwells
 - Roof access
 - Non-standard elevator keys
- Building Systems
 - Mid-rise structures typically do not have a Fire Control Room as in high rise buildings
 - A fire alarm panel is required in all new construction since 2002, and are typically located at the main entrance, in and around the building management offices
 - Some older mid-rise buildings do not have a standard fire alarm panel
 - There may be no fire alarm panels or displays in any exterior or remote entrance points to the building
 - Mid-rise structures built since 2002 are required to be sprinklered
 - The location and number of sprinkler heads is determined by the construction methods and features of the specific building
 - Mid-rise buildings do not typically have fire pumps unless unique building or water issues are present
 - Mid-rise buildings typically use city water pressure for the wet sprinkler systems and for the standpipe systems (when a combination system is present)
 - Standpipes may not be present in every stairwell
 - Standpipe supply connections may be at one specific location or decentralized depending on the footprint of the building
 - Standpipe connections may be present in interior hallways due to the length of the hallway or the distance from the stairwell standpipe connections
 - Some standpipe connections can be up to 200' apart depending on the sprinkler system in the building
 - Fire department connections (FDC) and *interior* standpipe connections may have KNOX locking caps in place and require the “dog bone” keys for access

- Wet standpipe systems with city water pressure above ground level may have inadequate water volume and pressure to mount an effective fire attack
 - Elevators in mid-rise buildings may not have centralized elevator monitoring in the lobby
 - Elevators may not recall in all areas if alarm occurs in a specific location
 - Mid-rise buildings typically do not have floor and stairwell pressurization or smoke evacuation systems
 - Smoke detectors are typically found in residential units and at the elevator lobby(s)
 - Automatic closing fire/smoke doors can be present in long hallways that are initiated by the fire alarm
 - Each residential unit will typically have independent HVAC systems that are not tied to the building systems
 - Commercial mid-rise buildings may have centralized HVAC systems with central monitoring and/or control
 - Security systems are common and can have multi-layered approaches requiring keys or a key fob for access from the exterior and then onto individual floors and units
 - Stairwells may not connect to all floors depending on the footprint of the building
 - Roof access is required however not standard in location
 - Gate arms and barricades leading to parking garages may be present and are sometimes added after final construction inspection
- Occupancy type
 - Residential mid-rise occupancies typically have an interior hallway layout with independent units on both sides of the hallways
 - Some residential mid-rises have multi story/level units
 - Residential units can be configured in many layouts with open floor plans
 - Commercial mid-rise occupancies have multiple configurations ranging from center hallway to open floor plans
 - Many mid-rise buildings have a combination of business on the lower level and residential on top
 - The lower level may not have interior communication/access to the upper levels
- Building construction
 - Mid-rise buildings have many different construction types
 - Modern residential mid-rise occupancies combine masonry and concrete in the lower level and wood framed construction in the upper levels
 - Wood framed mid-rise structures are combustible and the structural integrity will erode if the fire extends into the structure

- Modern residential mid-rise occupancies can have multiple roof types depending on the construction methods
 - Residential mid-rise units can range in size from small (< 1,000 square feet) to very large (> 3,000 square feet)
 - Overall building size can have a large impact on operations as well as large number of occupants
 - Some buildings take up entire city blocks in size
 - Commercial mid-rise occupancies can have a more standard steel and lightweight concrete construction closely related to high rise construction
 - Modern mid-rise buildings are sealed tightly and resist exterior/interior air exchange to improve energy efficiency for cooling
 - Some mid-rise buildings have exterior opening window or doors however not all
 - Many mid-rise buildings have underground parking directly beneath the overall footprint of the building
 - Many mid-rise buildings have recreational spaces on the roof including pools, recreation rooms, and bars
- Resources
 - Dependent on the smoke and fire conditions and the life safety potential, a rapid determination of the required resources is necessary
 - Resources should be considered for external rescue and access
 - It will be necessary to appropriately support the fire floor for fire attack and rescue, the floor above for rescue and fire extension, and the critical exposures for loss control
 - Consideration should be given for staging resources close enough to the building and access points to decrease the in transit time and to not congest key tactical positions
 - It is possible to develop an incident organization with significant complexities and the utilization of branches should be considered

STRATEGIC LEVEL CONSIDERATIONS

As in most fireground scenarios, the better the decision making and initial actions at mid-rise fires from the beginning, the more likely of the most positive outcome. Effective evaluation of the incident conditions and the ability to locate the fire as quickly as possible are foundational to effective operations. A pessimistic evaluation of the required resources to manage an effective fire attack and provide for the rescue or isolation of victims, on potentially multiple floors, is critical.

A focus on locating the fire as early as possible allows for the most effective identification of the critical tactical positions. Effective sectorization improves the span of control, supervision of

critical work, and command safety. Clear functional or positional sector assignments will improve the work outcomes and the safety of the firefighters working.

To execute the possibility of exterior rescues, apparatus placement becomes a critical consideration. The ability of aerial ladders, platforms, and ground ladders to access areas with rescue situations requires the consideration of the making those apparatus locations a priority. It will be necessary to provide access for multiple ladder companies to make simultaneous rescues when necessary, and search from exterior access points. These locations are also a consideration for access to initiate a fire attack if interior access is delayed.

Exterior aerial apparatus should also be considered for standpipe operations if an interior attack is delayed, or interior conditions won't allow safe operations with hose stretch distances and SCBA air consumption. In these instances, effective water supply, appropriate hose and nozzle selection is critical. The critical positions that must be considered include:

- ***Exterior rescue***
 - Determine the location and means of removal
 - Determine the resources required for rescue
 - Coordination with interior fire attack or search teams
 - Coordination with secondary needs for treatment and transportation

- ***Fire floor(s)***
 - Determine and monitor the fire attack stairwell
 - Determine and monitor evacuation stairwell based on conditions and access
 - Determine fire occupancy(s)
 - Determine structural involvement
 - Determine if the fire is in spaces between floors and attic/cockloft
 - Determine if wind driven conditions are present
 - Determine impacted exposures on fire floor
 - Recognize possibility of cold smoke situations with fires extinguished by the sprinkler systems prior to fire department arrival
 - Recognize possibility of stack effect conditions with smoke well below the fire impacting life safety and egress
 - Coordinate an effective fire attack with appropriate water volumes
 - Rescue profile and best actions (*protect in place or rescue*) determined by conditions
 - Establish and monitor effective water supply to fire floor
 - Determine the need for ventilation and smoke management
 - Establish and monitor safe refuge for fire attack and search companies
 - Determine resources needed to effectively complete the tactical objectives and facilitate effective air management

- ***Floor(s) above***
 - Rescue profile and best actions determined by conditions
 - Determine fire extension
 - Determine structural involvement
 - Determine if wind driven conditions are present
 - Confirm and monitor evacuation stairwell based on conditions and access
 - Monitor effective water supply to floor(s) above
 - Establish and monitor safe refuge for companies working on floor(s) above
 - Determine resources needed to effectively complete the tactical objectives and facilitate effective air management
 - Large area, targeted search
 - Room by room or unit by unit search in areas that were exposed to smoke and heat
 - Fire control has been achieved and ventilation and checking for extension are in progress
 - Consider multiple crews in attack teams
 - Allow for sufficient time to complete
 - Should not be confused with a primary search to achieve an all clear
 - Should not be conducted with smoke and fire conditions present (IDLH) without hose lines or the use of SCBA's
 - Human factors
 - Occupants may not shelter in place
 - May attempt to exit the building floor via most familiar routes
 - Clearly identify attack and evacuation stairwells from each floor

The recognition of secondary tactical positions to support the initial fire attack and rescue efforts includes:

- Triage
- Extrication
- Treatment
- Transportation
- Ventilation
- Building systems
- Occupant Services

TACTICAL LEVEL CONSIDERATIONS

Effective tactical level (sector) management is the balance of decisive action to extinguish the fire, protect life safety, and effectively manage the safety and welfare of the operating crews. This includes clear plans to establish an effective fire attack with adequate water, remove and/or protect the victims, or support these actions from other positions. Sector management should include the following considerations:

- Development of a plan for exterior rescue with adequate resources that are capable of these functions
- Development of a plan to extinguish or support the extinguishment of the fire as quickly as possible
- Development of a plan to manage or support the rescue and/or protection in place
- Development of a plan for thorough fire extension investigation in all exposed areas
- Establishing and maintaining effective access
- Establish and maintain effective water supply
- Establish and maintain an area of safe refuge for fire companies
- Direct coordination with other Sector Officers
- Manage position and function of all units assigned to Sector
- Provide for 3 deep resource layers of working, on-deck, and recycling
- Accountability can be conducted via radio when required

Sector management must be done from a position outside of the smoke and fire conditions. Sector Officers attempting to operate in smoke and heat conditions are not able to effectively manage the work and communications when attempting to manage their own accountability and air consumption.

It is possible the building layout could require hose stretches of more than 150 feet. When this occurs a clear assessment of the required action and the position in the risk management plan is critical.

The simple expectation is that no fire company should operate on the interior of any structure, during firefighting operations, beyond their ability to retreat to an area of safe refuge prior to their low air alarm going off.

TASK LEVEL CONSIDERATIONS

Task level considerations for fires in mid-rise structures is built on sound decision making, fundamental task completion, and effective air management. They involve understanding the task level functions that are assigned and executing them within a plan or in coordination with other companies to achieve the tactical objectives.

Task level considerations should include:

- Size up and Decision Making
 - Assessing fire and smoke conditions and behavior
 - Assessing flow path conditions
 - Hoseline selection for reach and appropriate water volume
 - Assessing for the presence of wind driven conditions
 - Effective size up for most critical areas requiring search simultaneously with fire attack

- Effective air management in coordination with crew members and Captain
- Effective management of access to safe refuge in the case of condition changes or low air levels
- Fundamental task completion
 - Standpipe pumping operations and supporting the sprinkler systems with appropriate water supply
 - Forceable entry
 - Standpipe cap lock removal
 - Standpipe connection and hose deployment for appropriately sized attack line and nozzle
 - Targeted search in areas of greatest danger to victims
 - Effective hose line advancement and management
 - Effective hose stream management for cooling and extinguishment
 - Horizontal, hydraulic ventilation
 - Pressurization of stairwells with PPV fans
 - Management for roof access hatches/bulkhead doors for ventilation or pressurization
- Air Management
 - Utilize SCBA air when necessary
 - Assess the effort required to complete tasks
 - Plan for an exit of the contaminated hazard zone prior to low air alarm sounding
 - Utilize standard fireground triggers to check air
 - Plan for bottle change-out inside the building in an area of safe refuge
 - Communicate air status with Captain at regular intervals that do not negatively impact the work

CRITICAL SAFETY CONSIDERATIONS

Mid-rise structures pose unique safety concerns for firefighters. They have unique features unlike high rise or more common apartment buildings. The greatest safety challenges include up to 6 stories of combustible building material, fire travel in void spaces, structural integrity under fire conditions, and interior layouts requiring hose stretches greater than 150 feet.

The absolute best action for potential victims and the safety of firefighters at any fire is to extinguish the fire as quickly as possible in its smallest state. Specifically, the best operation at a mid-rise fire is to extinguish the fire as quickly as possible to protect savable victims as well as decrease the likelihood of structural involvement and fire extension to other compartments. This requires effective size up to recognize when an aggressive, overwhelming fire attack is the best plan. It also requires recognition of when conditions are beyond the ability to control effectively by a standard interior fire attack.

When operating in an Offensive Strategy and conducting an interior fire attack and rescue operations, special consideration must be taken for structural integrity of floors surfaces and floor joists separating floors. Any fire involvement in these spaces can create localized failure and create opportunities for falls through the floor. The fire code requires sprinklers in the floor joist space when the joists/trusses are open web design. It does not require sprinklers in these spaces when the joists/trusses are solid (such as TJI joists). Areas with plumbing or air duct pass throughs is often opportunities for fire travel and weakening of the joist and structural members surrounding them. Floor integrity is often a concern in bathrooms and kitchens. It is difficult to know this information without preplanning and investigation.

When fire has spread into the structural members of a wood framed mid-rise building, this is a very dangerous situation. The loss of key structural members due to fire damage can significantly impact the overall structural stability of the entire building. Recognition of fire involving the structure should be reported to Command immediately. The Sector Officer and Command must determine if it safe and reasonable to continue in an Offensive Strategy. They must consider whether it is possible to write off portions of the structure or it requires writing off the entire building. A multi-story building with structural members burning is a dangerous situation.

Complex interior layouts with long interior hallways provide challenges for hose stretches of greater than 150 feet and effective air management. Standpipe outlet placement in stairwells and wall outlets in interior hallways are a necessary component to making a fire attack. When these are positioned in a manner that is greater than 150 feet from the fire occupancy/compartments, special consideration must be made for a fire attack and the ability to effectively manage adequate SCBA air while executing fire control and an all clear. Firefighters running out of air in contaminated atmosphere is *not an option*.

Fire radio communications may experience challenges in mid-rise buildings. This will depend on the location of crews working on the interior as well as the size and building construction methods present. This may require similar communication work arounds such as in high rise buildings including radio to radio relaying. Interior tactical positions may need to evaluate their location based on the communication abilities to manage the command system integrity. It is critical that all mid-rise fire operations always be conducted on hazard zone radio channels.

PHOENIX REGIONAL STANDARD OPERATING PROCEDURES	
Policy Name: PERSONAL MOBILITY DEVICES AND LITHIUM-ION BATTERIES	Policy Number: M.P. 202.20C
This policy is for internal use only and does not expand an employee's legal duty or civil liability in any way. This policy should not be construed as creating a duty to act or a higher duty of care, with respect to third party civil claims against employees or the Phoenix Fire Department (PFD). Remedies for violations of this policy, if proven, are limited to administrative disciplinary action against PFD employees.	
Related Policies: 205.20, 205.20A, 202.19, 202.19A	
Other Reference:	
Date Implemented: 07/2023-R	Review Date: 07/2028

Lithium-Ion Batteries are found in many consumer products today. Examples of where they are found is cell phones, electric scooters and bicycles, even residential garage door openers often have a Lithium-Ion battery backup built in. This policy/procedure is intended to provide direction on handling these devices when they have been impacted either through radiated heat, direct flame contact, or physical damage.

The hazards of Lithium-Ion batteries are well documented, they represent an increased risk to building occupants and firefighters when they have failed, gone into thermal runaway or when they have been damaged. Some of the hazards are toxic and flammable gases, height heat release rates, the potential for projectiles and the threat of delayed ignition which can cause a secondary ignition.

Fire hazards are relevant in the following two areas of response:

1. Initial Fire Attack, the involvement of Lithium-Ion batteries has the potential to dramatically impact fire growth rates.
2. Heat impacted Lithium-Ion batteries can have a delayed failure that represents a secondary ignition source.

PERSONAL MOBILITY LITHIUM-ION FIRE SOG

RESPONSE/MITIGATION

Develop an Incident Action Plan (IAP) to complete the Tactical Objectives.

- The primary fire attack with minimum 1 ¾" fire hose with water.
- Full PPE with facepiece. Consider a water supply if the batteries are continuing to propagate into thermal runaway.
- Upgrade to a 3-1 Hazmat.

- Extinguishment with Foam or ABC extinguishers is contraindicated.
- The batteries can be submerged in a bathtub or bucket of water to cool them and limit the products of combustion and allow to develop a more detailed IAP coordinated with HAZMAT.
- Even after extinguishment or submersion the batteries can still off gas and ignite.

ISOLATION

After extinguishment a thorough search of the area for exposed, damaged, burned batteries must be performed prior to any overhaul. Batteries could have ruptured dispersing many smaller cells throughout the room or area. It is important to locate and remove all batteries to prevent a secondary fire. This is easiest done prior to burying them in overhaul debris.

- Full PPE will be worn with face piece and a charged hose line in place.
- Scan the fire affected area to identify any heat impacted Lithium-Ion batteries.
- Remove these batteries using buckets or containers.
- Consider submerging in water, or overpacking.

Note: The investigation of fires and the determination of their cause is a responsibility of the Phoenix Fire Department (or automatic aid partner authority having jurisdiction). The primary reason for the investigation of fires is for the collection of information regarding the origin and cause. The origin and cause of a fire is determined to prevent similar occurrences in the future. If the origin and cause investigation indicate that the fire may have been intentionally set, the investigation is expanded to collect evidence related to a crime.

When possible, overhaul operations should be appropriately coordinated to prevent the destruction of evidence necessary for the determination of the origin and cause of the fire.

Please continue to remain dedicated to scene preservation to prevent the destruction of critical evidence at the fire scene. In most cases, this is as simple as remaining cognizant of scene preservation during overhaul operations.

Some of the observations that we make at fire incidents may lead us to consider contacting a fire investigator. If you have any reason to believe the cause of any fire to be suspicious, please contact the Fire Investigations Section as soon as possible through the Alarm Room.

REMOVAL OF BATTERIES

Ongoing thermal runaway and electrocution hazards due to stranded energy should always be considered. Whenever handling or near the batteries full PPE must be worn with a charged hose line in place.

- Avoid hand carrying the batteries. Utilize buckets, shovels, tarps, and nonconductive tools.
- If the occupancy is on upper floors, consider using a Fire Department aerial device to lower the batteries to the ground.

- **The use of elevators or enclosed stairwells should be avoided.**
- Some personal mobility devices can be larger (Electric Wheelchair). The use of a thermal blanket should be considered if forced to remove the batteries through interior areas.

OVERPACKING

Depending on the size of the mobility device the batteries may need to be removed or cut away from the E bike, scooter, hoverboard, etc. The use of extrication tools or saws may be employed. This tactic must be coordinated with the IC, Safety and Hazmat and should be done outside with a charged hose line, and full PPE. When possible, Lithium-Ion batteries should be placed in a metal vented container, to prevent the buildup of pressure. The metal container should be rated for the Watts the battery produces (Volts X Amps = Watts).

- Place a small amount of Cellblock, dirt, or other thermal regulating material in the bottom of the container then cover it with more of the same material.
- This should be done by Hazmat Techs or clean up contractors.

TERMINATION OF THE EVENT

The potential for a secondary fire due to stranded energy should always be considered. Command Officers should:

- Time stamp through alarm that the owner/manager has been made aware of the requirement to use a proper Hazmat disposal contractor.
- Consider the need to keep a crew on scene through the investigation phase.
- Consider having the Fire Department coordinate the removal of batteries from high risk/high density occupancies.
- Only certified/permitted disposal companies can transport damaged Lithium-Ion batteries.

**PHOENIX REGIONAL
STANDARD OPERATING PROCEDURES**

EMS RESPONSIBILITIES

M.P. 203.01

03/00-R

Page 1 of 9

Scope

This procedure establishes a standard structure and guideline for the operation of Fire Department units at multi-patient/mass casualty incidents. The system may be applied to any multi-patient or mass casualty incident regardless of the number of patients or incident size. This procedure shall be integrated into the overall incident management system and may include major transportation incidents, explosions or fire with multiple injuries, hazardous materials incidents with exposure victims and structural collapse incidents.

Policy Statement

The policy is to integrate the multi-patient/mass casualty procedures within the framework of the incident management system. It is the responsibility of the first-arriving company officer to implement these procedures on EMS incidents requiring the commitment of a two-and-one medical (2-1-M) or greater.

For the purposes of this procedure, a "multi-patient incident" is defined as any incident with fewer than twenty (25) patients. A "mass casualty incident" is defined as any incident involving 25 to 100 patients. A "disaster" is defined as any incidents involving more than 100 patients.

Procedure

The first-arriving company officer at the scene of a multi-patient or mass casualty incident shall establish Command. The initial Incident Commander (IC) shall remain in Command until Command is transferred or the incident is stabilized and Command is terminated. Command is responsible for the completion of the tactical objectives. The general tactical objectives, listed in order of priority, are:

1. Remove endangered occupants and treat the injured.
2. Stabilize the incident and provide for life safety.
3. Ensure the functions of triage, extrication, treatment and transportation are established as needed and performed appropriately.
4. Provide for the safety, accountability and welfare of rescue personnel and victims.
5. Conserve property.

In addition, the EMS TACTICAL objectives to be completed during any multi-patient/mass casualty incident include:

1. Completion of a "Triage Report"
2. Declaration of "All IMMEDIATES Transported"

The Incident Management System is used to facilitate the completion of the tactical objectives. The IC is the person who drives the Command system towards that end. The IC is responsible for building a command structure that matches the organizational needs of the incident to achieve the tactical priorities.

**PHOENIX REGIONAL
STANDARD OPERATING PROCEDURES**

EMS RESPONSIBILITIES

M.P. 203.01

03/00-R

Page 2 of 9

When possible, patients should be treated and transported in the following priority order:

1. IMMEDIATE
2. DELAYED patients upgraded to IMMEDIATE
3. DELAYED
4. MINOR

Basic Operational Approach

The initial actions of the first arriving officer shall be directed toward scene size-up, requesting appropriate resources and initial organization of the scene. Initial actions include:

1. Give an on-scene report and assume command. Initiate triage.
2. Perform a rapid hazard assessment and establish a safe zone to operate. Initiate traffic control and provide a safe work/treatment area.
3. Provide for occupant protection (charged hand line).
4. Call for additional resources.
5. Radio a Triage Report to Dispatch.
6. Stabilize hazards and/or remove patients to a treatment area.
7. Assign crew(s) specific task(s) to accomplish.
8. Early sectorization (triage, extrication, treatment, and transportation) or by location (north, south, east, west).
9. Initiate patient assessment and treatment functions.
10. Coordinate patient transportation.

Responding personnel are encouraged to use triage tags and IMMEDIATE labels on smaller multi-patient incidents. Triage tags should be used any time there are three (3) or more IMMEDIATE patients or more than ten (10) patients. In the multi-patient incident scenario, most often a multiple vehicle collision, use of the Central Arizona triage system (See MP 1201.14) can greatly improve initial scene organization, and enhance its use during mass casualty incidents.

Arrival

The first arriving company officer at a multiple patient incident will assume Command and give an on scene report which will answer the question. . . *What do I have? What action will I take? What resources do I need?* The type of situation and the approximate number and condition of patients should be communicated to Dispatch as soon as possible.

Command should rapidly survey the scene to identify any hazards or safety concerns and establish a safe zone for crews to operate. This can be accomplished through proper defensive rig positioning, use of flashing lights and the placement of flares or reflectors. Additional traffic control should be requested from law enforcement through Dispatch.

Command should immediately request additional assistance if the need is indicated. Dispatch will begin to notify other agencies and medical facilities based on the amount of assistance requested at the scene and the progress reports from Command. The initial reports should indicate the scale of the incident to allow Dispatch to notify other agencies.

**PHOENIX REGIONAL
STANDARD OPERATING PROCEDURES**

EMS RESPONSIBILITIES

M.P. 203.01

03/00-R

Page 3 of 9

Triage will be initiated early in an incident, especially when the number of patients and/or the severity of their injuries exceeds the capabilities of the on scene personnel to provide effective extrication, treatment and transportation.

Once triage is complete, a Triage Report should be radioed to Alarm. A Triage Report at a two-vehicle collision may sound like: "*Triage to Command. Triage is complete. We have 9 total patients: 2 IMMEDIATES, 3 DELAYED and 4 MINORS.*" A Triage Report signifies that triage has been completed and communicates to all responding crews the size of the major medical incident. It also provides essential information regarding decisions to call for additional resources or to scale back the response.

The first arriving company officer needs to quickly determine the most effective means to treat patients. In incidents with few patients, it may be more effective to treat patients "in place." At EMS incidents with a greater number of patients, a treatment area should be established. In a case where two or more distinct groups of patients are separated by distance, multiple treatment areas may be needed. Treatment area(s) can be clearly identified by using colored salvage covers (red, yellow and green) to designate treatment areas for IMMEDIATE, DELAYED or MINOR patients.

If the incident involves a building collapse or a hazardous material release, it may be more effective to remove victims to a safe area rather than stabilize hazards. This is also true of motor vehicle collisions involving a train wreck or bus. In these cases, triage will be performed at the entrance to the treatment area.

Staging

Additional Resources should be requested using standard assignments and alarms as much as possible (e.g., 2-1 Medical, 1st Alarm Medical, 2nd Alarm Medical, etc.) This will facilitate an incremental approach to the incident, similar to firefighting operations, and provide predictable resources.

The first arriving company will go to the scene, as well as the first paramedic unit, first ladder, first chief officer, and first rescue. All other companies will use Level I staging upon their arrival.

Command should consider implementing Level II Staging early in the incident. All First-Alarm-Medical Incidents (or greater) require a Level II Staging Area for all fire department resources, including rescue companies.

All outside agencies responding to a medical incident should be sent to the Staging Area. This area should be at a sufficient distance to keep the scene clear and maintain access. Staging officer will assign units as directed by Command.

Units assigned to sectors, unless carrying special equipment, should park at a distance from the scene. This parking area should be located out of the access paths. Crews should report to Extrication or Treatment Sectors carrying their medical equipment. If a treatment area is designated, medical equipment and supplies should be stockpiled there.

**PHOENIX REGIONAL
STANDARD OPERATING PROCEDURES**

EMS RESPONSIBILITIES

M.P. 203.01

03/00-R

Page 4 of 9

Apparatus with extrication tools or other heavy equipment needed at the scene should be brought up closer to the actual incident site.

Command Responsibilities

The Incident Commander (IC) is responsible for the strategic level of the command structure and should:

- Determine the appropriate strategy
- Establish overall incident objectives
- Set priorities
- Develop an action plan, communicate plan.
- Obtain and assign resources.
- Planning—based on evaluating interventions and predicting outcomes
- Communicate specific objective to tactical level units
- Initiate a Unified Command with other agencies

Basic Sectors

Most multiple-patient incidents require patient triage, extrication, treatment, and transportation. Because of potential vehicle congestion at the site, a staging sector for apparatus is also a major consideration during larger incidents.

These needs form natural basic sectors for the Incident Management System. Additional sectors may be assigned depending on the situation, consistent with the Incident Management System.

The purpose of Triage Sector is to determine, in close coordination with Extrication, the location, number and condition of patients and whether triage should be performed before or after patients are extricated from the site. Triage is also responsible to assign and supervise triage teams, ensure that patient triage is done in accordance with standard operating procedures and provide Command with a "Triage Report" when triage is completed. Triage Sector should also forward triage tracking slips to Command.

The purpose of Extrication Sector is to determine, in conjunction with Triage, the location, number and condition of patients and whether triage will be performed before or after patients are extricated from the impact area. Extrication is also responsible to assign and supervise extrication teams, extricate and deliver patients to the treatment area, and notify Command when all patients have been removed from impact area. MINOR patients who were directed earlier in the incident by triage teams to an Assembly Area will be assessed by Extrication and delivered to the treatment area if further medical care is warranted.

The purpose of Treatment Sector is to first determine whether patient treatment will occur "in place" or in a designated treatment area. Generally, a centralized treatment area is preferred, as patient care and site operations are substantially enhanced.

**PHOENIX REGIONAL
STANDARD OPERATING PROCEDURES**

EMS RESPONSIBILITIES

M.P. 203.01

03/00-R

Page 5 of 9

If a treatment area is designated, Treatment Sector may decide to treat patients in a common area. However, if the incident is large enough treatment may designate separate "IMMEDIATE" and "DELAYED" treatment areas. Treatment is responsible to assign and supervise treatment teams, ensure that all patients have been triaged, assessed and treatment needed. Treatment Sector officer should coordinate patient allocation with Transportation Sector and notify Command when all patients have been treated.

The purpose of Transportation Sector is to obtain all modes of transportation needed to take patients to the hospital. Transportation should determine, in conjunction with Command, the location of the staging area, rescue loading area and helicopter landing zone. Transportation Sector is also responsible to determine hospital availability through the Dispatch Center, coordinate patient allocation with Treatment and supervise the movement of patients from the treatment area to the ambulance loading area or helicopter landing zone.

Transportation Sector should also determine hospital destination and notify hospitals of rescue or ambulance arrival (through Dispatch). Transportation should also remove patient tracking slips from the triage tag prior to transport, notify Command when all Immediate patients have been transported (an EMS Tactical benchmark) and maintain an accounting of all patients.

ADDITIONAL SECTORS

Safety Sector

Command should assign Safety Sector as soon as the basic sectors have been established.

As the incident escalates, a Staging Sector may be required. To avoid scene congestion, a Level II staging area will be identified for any First Alarm Medical incident.

Medical Supply Sector is responsible for the procurement, delivery and stockpiling of medical supplies needed at the scene. This sector should be established on 3rd Alarm Medical or greater incidents, as Medical Support 19 (from the airport) and a Medical Supply truck (from Resource Management) will automatically be dispatched. These units will have medical supplies, oxygen refill capability and oxygen distribution system.

If helicopters are used, an LZ Sector will be established with a landing zone a safe distance from the scene. LZ Sector will keep track of patient destination, communicate landing instructions with incoming and outgoing aircraft and enforce established safety standards for landing zones (Brush Fire Air Support). At least one Engine Company will be assigned to the LZ.

Branches

A mass casualty incident may require the implementation of a separate "Medical Branch" and "Transportation Branch." Each would direct all sectors assigned and report to Command.

**PHOENIX REGIONAL
STANDARD OPERATING PROCEDURES**

EMS RESPONSIBILITIES

M.P. 203.01

03/00-R

Page 6 of 9

The Medical Branch Director is responsible to ensure that the functions of triage, extrication, and treatment are carried out. The Medical Branch Director should supervise and coordinate personnel assigned, determine and request resources needed and recommend the expansion of the command organization as needed. Medical Branch should communicate direction and objectives to tactical units, ensure objectives are completed and maintain incident documentation.

Additional positions within the Medical Branch may include an IMMEDIATE, DELAYED and MINOR Treatment Sector Officers, Medical Communications Sector, Medical Supply Sector, Ground Ambulance Coordinator and Morgue Officer.

Resource Commitment and Flow

Resource commitment typically follows patients. Initially, Extrication will require a large resource commitment. As patients are extricated and moved to Treatment, resources for extrication will decrease. These crews can be re-allocated to the Treatment function.

In a disaster level incident, some fire department resources may need to be allocated to receiving hospitals until those facilities can obtain adequate hospital staff.

PHOENIX REGIONAL
STANDARD OPERATING PROCEDURES

EMS RESPONSIBILITIES

M.P. 203.01

03/00-R

Page 7 of 9

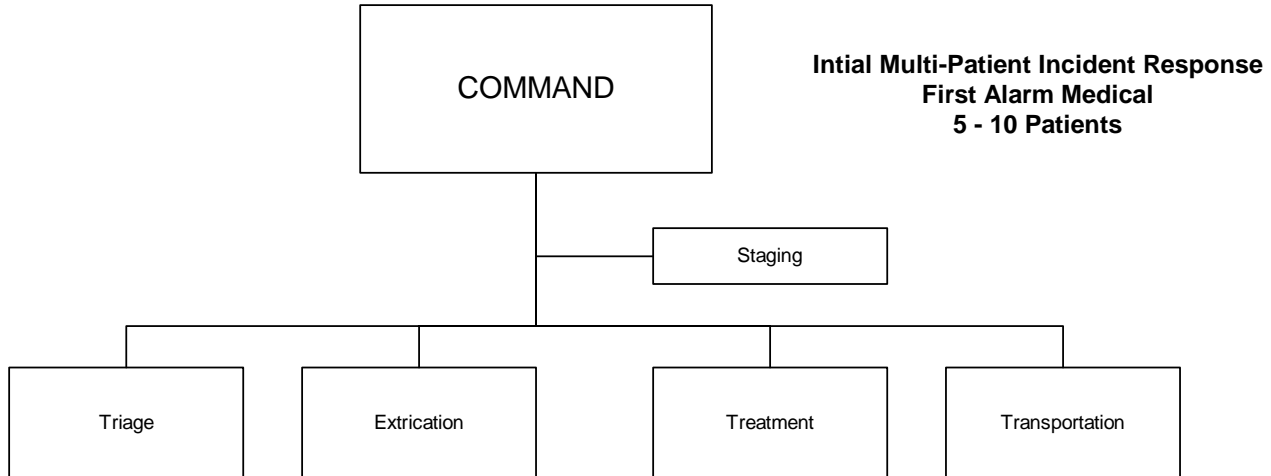

NOTES:

1. The triage function should be performed by the first arriving company. Normally, it will last 4-6 minutes. A sector assignment may not be necessary.
2. Extrication may be assigned, if needed, when physical disentanglement or patient removal to a treatment area is needed.
3. Treatment is preferred in a designated treatment area, or can be performed "in-place," as directed by Command.
4. The Transportation Sector function may be managed by Command or assigned to a designated member, depending on complexity of the incident.
5. A Level II Staging area should be used for the balance of the assignment (after the Level 1 approach). All resources must stage.

PHOENIX REGIONAL
STANDARD OPERATING PROCEDURES

EMS RESPONSIBILITIES

M.P. 203.01

03/00-R

Page 8 of 9

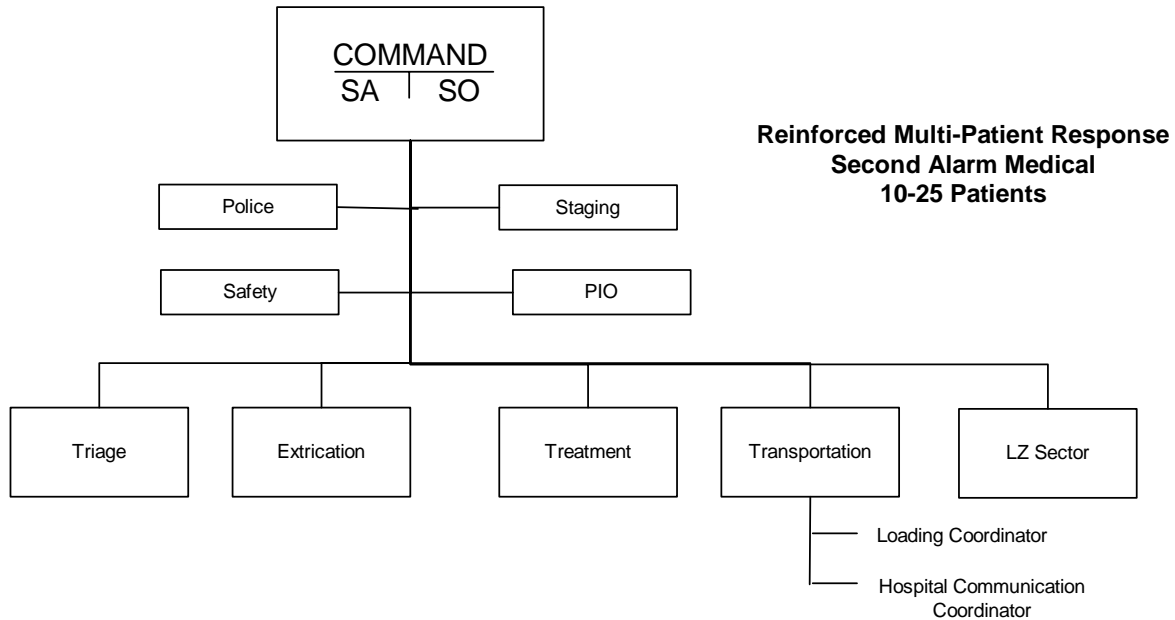

NOTES:

1. A Triage Sector should be assigned.
2. The Extrication Sector should be assigned to manage physical disentanglement or removal of patients from the impact site to a treatment area.
3. A Treatment Sector should be established with colored salvage covers used to identify Immediate, Delayed, and Minor treatment areas.
4. Transportation Sector will need a minimum of one company assigned to perform its functions, and be assigned a separate tactical channel, in addition to Med-9.
5. A LZ Sector will be used for helicopter operations.
6. A minimum of one engine company should be assigned to the LZ, with the Company Officer becoming "LZ Sector."
7. The Hospital Communications Coordinator should check on hospital availability through Dispatch on Med-9.
8. A Level II Staging area must be established for all responding companies.
9. Rescues should be sent to loading area, no more than two at a time.

**PHOENIX REGIONAL
STANDARD OPERATING PROCEDURES**

EMS RESPONSIBILITIES

M.P. 203.01

03/00-R

Page 9 of 9

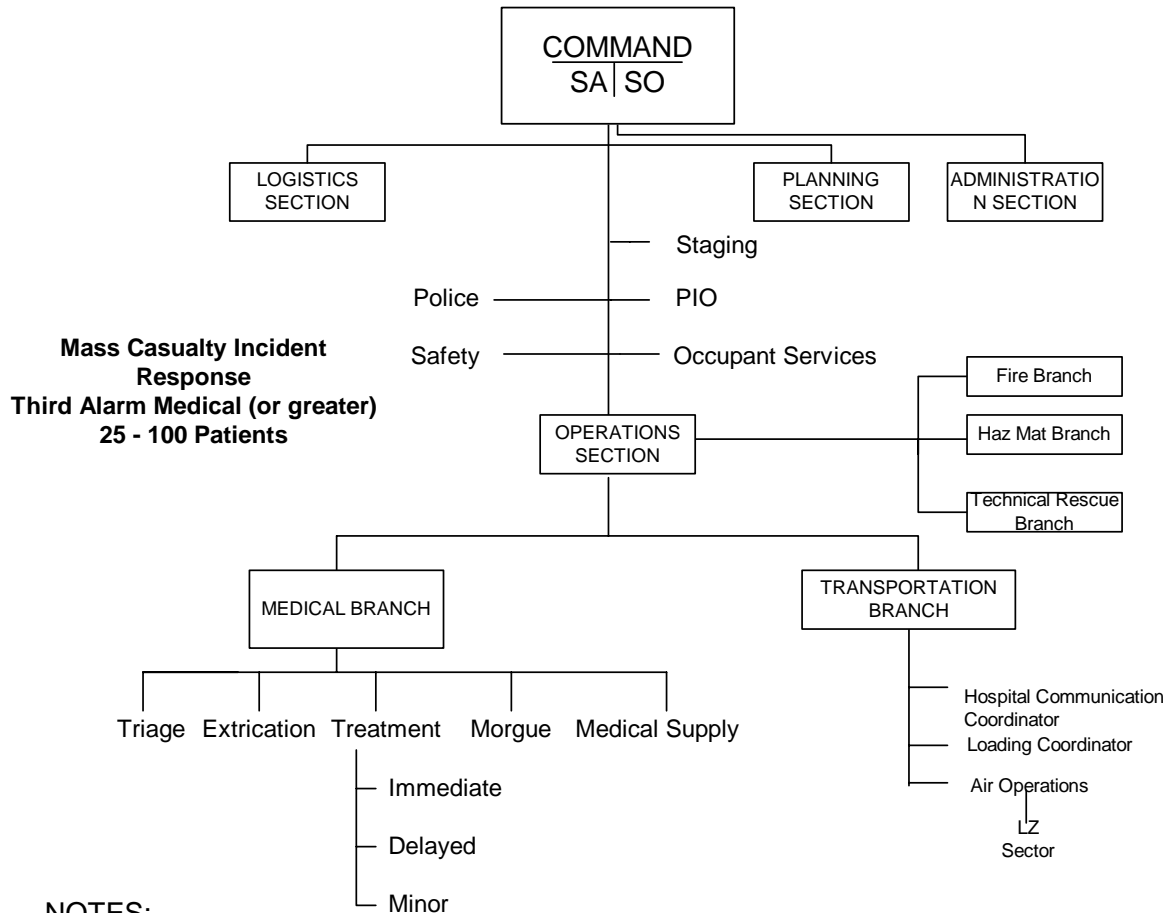

NOTES:

1. Triage should continue as a Sector and may involve several companies.
2. The treatment area must be identified early and include patient re-evaluation.
3. Medical Branch and Transportation Branch should be considered with a large number of patients.
4. Transportation Branch has a Loading Coordinator assigned to the treatment area.
5. Transportation Branch will need a minimum of one company assigned and should operate on a separate tactical radio channel, in addition to Med-9.
6. A minimum of one engine should be assigned to the LZ, with the Company Officer assigned as "LZ Sector."
7. The Hospital Communication Coordinator should check and re-check hospital availability through Dispatch on Med-9.
8. Rescues should be sent to the loading area, no more than two at a time.
9. Medical Support 19 and one medical supply truck will be dispatched to the scene when a Third Alarm is requested (see Medical Supply Sector).

**PHOENIX REGIONAL
STANDARD OPERATING PROCEDURES**

TRIAGE SECTOR

M.P. 203.02

03/00-R

Page 1 of 2

The purpose of triage is to categorize patients based on the severity of their injuries, prioritize their need for treatment and transportation and stabilize life-threatening injuries before additional resources arrive on-scene.

With this in mind, extrication and triage sectors should be assigned separately. This follows the *Model Procedures Guide for Emergency Medical Incidents* (National Fire Service Incident Management Systems Consortium, 1996) and clearly distinguishes between two important, though distinct functions. . . identifying patient number and severity (triage), versus victim disentanglement and removal to a treatment area (extrication).

Triage Sector Responsibilities

The following items represent the standard operations that will normally be performed by the Triage Sector officer:

1. Determine the location, number and condition of patients.
2. Determine, in close coordination with Extrication Sector, if triage will be performed in place or at the entrance to the treatment area.
3. Determine resources.
4. Assign and supervise triage teams.
5. Ensure that patient triage is based on *S.T.A.R.T.*, that life-saving emergency medical care is provided as needed, and that patients are accounted for and tagged appropriately.
6. Ensure safety and accountability of all assigned personnel.
7. Provide frequent progress reports to Command.
8. Coordinate activities with other sectors.
9. When triage is complete, provide Command with a "Triage Report." Forward triage tracking slips to Command.
10. Terminate triage activities and inform Command that personnel are available for reassignment.

The Triage Sector Officer should wear a sector vest for identification purposes.

At smaller incidents (up to 10 patients), triage may be handled by the first arriving company officer and his/her crew. At larger incidents (more than 10 patients), the first arriving company officer should assume Command and assign Triage to the next arriving fire company.

As a general rule, patients should be triaged and tagged before movement to a treatment area. IMMEDIATE patients are moved first, followed by DELAYED patients. However, there are instances when triage is performed away from the impact area.

Depending on the safety of the site and the arrangement of the patients, it may be necessary to triage patients at the entrance to the treatment area.

In a very large incident, it may be necessary to establish multiple triage locations. Regardless of where triage is performed, the triage process requires close coordination between the extrication and treatment sector officers.

**PHOENIX REGIONAL
STANDARD OPERATING PROCEDURES**

TRIAGE SECTOR

M.P. 203.02

03/00-R

Page 2 of 2

Triage tagging should be completed in accordance with procedures established in Volume 12 (“Triage Tagging”).

Triage Report

Triage should be completed using the “Arizona Triage System.” These red fanny packs are located on all fire apparatus. Once the triage crew(s) has tagged and labeled all patients, they should forward their tracking slips to the Triage Officer.

The Triage Sector Officer arranges the tracking slips to determine the number of patients and their condition. The Triage Sector Officer then radios Command with a “Triage Report.” The Triage Report includes the number of patients and their classification. For example, a Triage Report at a two-vehicle collision may sound like: *“Triage to Command. Triage is complete. We have 9 total patients: 2 IMMEDIATES, 3 DELAYED and 4 MINORS.”*

A Triage Report signifies that initial triage has been completed on the incident using the *S.T.A.R.T.* criteria. It communicates to all responding crews the size of the major medical incident. It also provides Command with essential information regarding decisions to call for additional resources or to scale back the response. Once triage is complete, Command may reassign triage crews to other functions.

**PHOENIX REGIONAL
STANDARD OPERATING PROCEDURES**

EXTRICATION SECTOR

M.P. 203.03

03/00-R

Page 1 of 2

An Extrication Sector is utilized in multiple patient incidents that require physical disentanglement and/or the removal of trapped victims. Extrication is responsible for removing and delivering patients to a treatment area. Extrication will assist triage with any patient treatment that is necessary prior to disentanglement.

Extrication and triage sectors should be assigned separately (see *Model Procedures Guide for Emergency Medical Incidents*, National Fire Service Incident Management Systems Consortium, 1996). This clearly distinguishes between two important, though distinct functions. . . identifying patient number and severity (triage), versus victim disentanglement and removal to a treatment area (extrication).

Extrication Sector Responsibilities

The following items represent the standard operations that will normally be performed by the Extrication Sector:

1. Determine the location, number and condition of all patients (coordinate with Triage).
2. Determine if triage will be performed in place or at the entrance to the treatment area (see "Triage Sector").
3. Determine resources.
4. Assign and supervise extrication teams.
5. Extricate and deliver patients to the treatment area(s) or to a casualty collection point.
6. Provide frequent progress reports to Command.
7. Ensure safety and accountability of all patients and assigned personnel.
8. Coordinate activities with other sectors.
9. Notify Command when all patients have been removed and that companies are available for reassignment.

The Extrication Sector Officer shall wear a sector vest for identification purposes

The Extrication Officer should be positioned in a readily visible location that is accessible to arriving companies and maintain a view of the scene. Face-to-face communications should be used within the sector. Company officers should use messengers to relay information to the sector officer. The sector officer shall provide frequent progress reports to Command.

As a general rule, patients should be triaged and tagged in the impact area. However, depending on the safety of the site and the arrangement of the patients, there may be instances when triage is performed at the entrance to the treatment area. Regardless of where triage is performed, the triage process requires close coordination between triage, extrication and treatment sector officers.

The first priority for removal to the treatment area will be IMMEDIATE patients followed by DELAYED patients. IMMEDIATE patients should be moved to a treatment area without delay. These patients can easily be spotted with night-reflective IMMEDIATE labels placed on or near their bodies by the triage team(s). In some cases of confined entrapment, removing "DELAYED" patients may occur before access can be gained to "IMMEDIATE" patients. These patients may need to be moved to the treatment sector ahead of "IMMEDIATE" patients.

**PHOENIX REGIONAL
STANDARD OPERATING PROCEDURES**

EXTRICATION SECTOR

M.P. 203.03

03/00-R

Page 2 of 2

All non-ambulatory patients should be moved on backboards, with cervical spine precautions if indicated. Companies may be assigned as "litter bearers" to assist in this movement. Pick-up trucks, baggage carts or similar conveyances may also be used. Full spine immobilization may not be possible during the early stages of an incident.

The Extrication Officer should assign personnel to help size-up the situation. An evaluation of the number of patients involved and the complexity of extrication requirements is an immediate priority. A reasonable guideline is an initial commitment of one company per five (5) victims.

This is reasonable for extending initial and immediate care when numerous patients are involved in a major incident. The goal, as resources and priorities permit, is to provide all resources necessary to extricate and move patients to the Treatment Sector.

If the patients are spread over a large area, Extrication should assign companies to a specific area or group of patients. The company officer assigned will determine the immediate needs of those patients and request assistance if necessary. The Company Officer has responsibility for all those patients until they are delivered to a treatment area or assigned to another company.

If the incident site involves a large area, it may be necessary to create more than one Extrication Sector. Responsibility should be divided geographically with appropriate sector designations. (e.g. "North Extrication). Branch operations may be required to coordinate this effort.

Most ALS personnel should be assigned to the Treatment Sector. However, some paramedics may also need to be assigned to the Extrication Sector to provide ALS treatment for critical patients undergoing extended extrication efforts.

When victims require forcible extrication, ladder companies should be assigned. Ladder apparatus should be brought in close to the scene while other apparatus is parked at a distance to avoid congestion. If the extrication requires specialized equipment (i.e., wreckers, cranes, cutting torches), these must be requested through Command.

The Extrication Officer is responsible for assuring the safety of the area where patients are being extricated. This will require the commitment of personnel with protective lines and extinguishing equipment where a fire risk exists. If fire is involved, coordination with firefighting sectors will be required. The safety of patients and Fire Department personnel must be a primary concern.

To reduce confusion and congestion, Triage will initially direct all MINOR (ambulatory) patients using the *S.T.A.R.T.* criteria to a specific area. Extrication Sector is later responsible to further assess these patients once more critical activities have taken place. Extrication may decide to remove these patients to an "Assembly Area." Green salvage covers can be used to identify this area. A city bus or other vehicle can be used to transport these people to a suitable location.

As patients are moved from the extrication area, fewer resources may be required. The Extrication Sector should advise Command when companies or personnel are available for reassignment.

**PHOENIX REGIONAL
STANDARD OPERATING PROCEDURES**

TREATMENT SECTOR

M.P. 203.04

03/00-R

Page 1 of 3

A Treatment Sector is utilized to provide a site to manage the treatment of multiple IMMEDIATE and DELAYED patients. Treatment Sector is responsible for establishing a treatment area to provide stabilization and continuing care of patients until they can be transported to a medical facility. The objective of the treatment sector is to rapidly treat and transport all patients.

Treatment Sector Responsibilities

The following items represent the standard operations that will normally be performed by the Treatment Sector:

1. Identify whether patient treatment will occur "in place" or in a designated treatment area. Coordinate with Triage and Extrication Sectors.
2. Determine resources.
3. Identify and establish a large treatment area. If incident is large, establish separate "Immediate" and "Delayed" treatment areas.
4. Assign and supervise treatment teams.
5. Ensure that all patients have been triaged, assessed and re-triaged as needed.
6. Aggressive treatment and rapid packaging of patients.
7. Provide frequent progress report to Command.
8. Ensure safety and accountability of all patients and assigned personnel.
9. Verify transportation priorities with Transportation Sector.
10. Coordinate with other sectors.
11. Notify Command when all patients have been moved from the treatment area.

The Treatment Sector officer will wear a sector vest for identification purposes.

The Sector officers should determine together with Command whether patients would be treated "in place" or treated at a specific treatment area.

If treatment will occur "in place," companies should be directed by the Treatment Sector officer to specific patient or vehicle (e.g., "E20, you have the patients in the red sedan. R17 will assist."). The goal will be to assign one ALS or BLS company and one Rescue to each patient, resources permitting. Crews should initially focus their effort on treating and transporting IMMEDIATE patients. These patients can easily be spotted with night-reflective IMMEDIATE labels placed on or near their bodies by the triage team(s). Treatment teams should communicate with Command to obtain additional Rescues.

If patient treatment will occur in a designated "treatment area", then the Treatment Sector officer should establish a treatment area and prepare for the arrival of patients from Extrication. The treatment entry point should be readily identified (e.g. traffic cones) and have personnel to direct arriving patients. The treatment area must be in a readily accessible location for patient entry and transportation loading but away from any dangerous conditions associated with the incident.

The treatment area should be large enough to absorb all patients and the large numbers of treatment personnel-**THINK BIG!** This area should be located in a safe area with consideration given to allow for easy access by rescues or ambulances. If the incident is large enough, Treatment should designate separate "IMMEDIATE" and "DELAYED" treatment areas.

**PHOENIX REGIONAL
STANDARD OPERATING PROCEDURES**

TREATMENT SECTOR

M.P. 203.04

03/00-R

Page 2 of 3

The treatment area(s) should have a readily identifiable entrance using traffic cones, signs or other markers. Red and yellow salvage covers can also be used to identify the IMMEDIATE care and DELAYED care areas, for IMMEDIATE and DELAYED patients, respectively. One salvage cover provides ample working room for up to three patients.

If the incident scene is very large, it may be necessary to establish more than one treatment area in different locations. Branch operations may be required to coordinate these efforts. Geographic designations (i.e., "East Treatment", "West Treatment") should be utilized ("Transportation Branch, Multiple Site Coordination").

Treatment shall advise Command when ready to receive patients.

Of all the sectors, the Treatment Sector typically requires the heaviest commitment of personnel. During major incidents, one company per four (4) patients should be the initial objective (one rescuer per patient). As resources permit, the overall goal is to provide all the resources necessary to treat all the patients.

Treatment should assign personnel to meet and direct first arriving litter-bearers on the placement of patients in "IMMEDIATE" and "DELAYED" Areas. Patients in the treatment area should be arranged in an orderly manner with adequate space provided between patients to allow working room for treatment personnel. First arriving patients should be placed near the exit point. Rescuers should first fill from exit towards the entrance as patients are delivered to treatment. This will eliminate personnel from having to step over or move around patients as they are delivered or transported.

Non-triaged patients arriving at the treatment area must be triaged and tagged at the entrance. A triage team should be located at the entrance for this purpose. As these new patients are tagged, the Treatment Sector officer should forward a "Triage Update" to Command to include these newly-discovered patients.

Treatment personnel must continue to assess all patients for changes in conditions, through an ongoing basis to maintain appropriate triage classifications. Once initial triage activities have been completed, triage teams can be reassigned to Treatment to continuously re-evaluate patients. ALS treatment will be given primarily in the "IMMEDIATE" treatment area. Less intensive patient monitoring and treatment will be given to the "DELAYED" treatment area with mostly BLS personnel assigned to this area. Medical information (vital signs, injuries, treatment rendered) should be documented on the appropriate side of the triage tag.

A variety of ALS personnel, BLS personnel, medical staff and others may be assigned to the Treatment Sector. The Treatment Sector officer must have specific assignments for these varied personnel. Non-fire department medical personnel should be closely supervised by the Treatment Sector officer or others. Command staff, branch directors and Sector officers will have full supervisory authority over this staff.

If the condition of a patient changes significantly (better or worse) it may be necessary to transfer the patient to a higher or lower priority area. The Treatment Sector officer should be advised. Once all IMMEDIATE patients have been treated, DELAYED patients who have significant mechanism of injury should be reevaluated and upgraded to IMMEDIATE as necessary.

**PHOENIX REGIONAL
STANDARD OPERATING PROCEDURES**

TREATMENT SECTOR

M.P. 203.04

03/00-R

Page 3 of 3

The Treatment Sector must cause aggressive treatment and packaging of patients with an emphasis on rapid transport. The Treatment Sector officer must maintain an immediate awareness of which patients are

ready for transport. The Sector officer must ensure treatment is rapid, adequate, and appropriate numbers of treatment personnel are assigned to each patient. The only time extended treatment should be considered is when immediate transportation is not available. Close coordination with the Transportation Sector officer must be maintained to ensure rapid transportation.

When transportation is immediately available, transportation of the patient becomes a priority over extended on-site treatment. Rapid transportation is of the essence.

The Treatment Sector officer will consult with the Transportation Sector on the allocation of patients to various medical facilities.

The Treatment Sector officer should forward progress reports and triage updates to Command as needed. The Treatment Sector officer is responsible for determining the need for additional medical supplies at the scene and should request their delivery through Command. A Medical Supply Sector will automatically occur on all 3-A-M incidents. This sector should be established near the treatment area ("Medical Supply Sector").

**PHOENIX REGIONAL
STANDARD OPERATING PROCEDURES**

TRANSPORTATION SECTOR

M.P. 203.05

03/00-R

Page 1 of 2

A Transportation Sector is established to manage patient transportation from the scene to appropriate medical facilities. Transportation Sector is responsible for arranging all of the transportation needs for a multiple-patient incident and for allocating those patients to appropriate medical facilities.

Transportation Sector Responsibilities

The following represent the standards operations that will be performed by the Transportation Sector.

1. Determine/request resources.
2. Determine (with Command) the rescue loading area and helicopter landing zone as needed.
3. Determine hospital availability status by contacting Dispatch on Med-9.
4. Coordinate patient allocation and destination with Treatment Sector.
5. Aggressively supervise the movement of patients from the treatment area to the ambulance loading area or helicopter landing zone.
6. Maintain an accounting of all patients and patient destinations.
7. Provide progress reports, allocations, ETA's, to receiving hospitals.
8. Ensure the safety and accountability of all assigned personnel.
9. Provide frequent progress reports to Command.
10. Coordinate activities with other sectors, especially Treatment.
11. Notify hospital (through Dispatch) of estimated arrival time of specific rescues or helicopters.
12. Notify Command when all IMMEDIATE patients have been transported.
13. Notify the hospitals when all patients are transported and operations are terminating.

The Transportation Sector Officer must assume a visible position in the treatment area or patient loading area and wear a sector vest.

The Transportation Sector Officer must "size up" the transportation needs, including ambulances, air ambulances or other transportation modes, as well as staffing needs and communicate those needs to Command. Additional personnel may be needed to assist with medical communications ("Hospital Communications Coordinator"), transport loading ("Loading Coordinator"), record keeping ("Charting Officer"), air medical transport coordination ("LZ Sector") and staging ("Staging").

Transportation should determine, in concert with Command, the location for staging and aero-medical (helicopter) transport. If helicopters are used, Transportation should establish a landing zone a safe distance from the scene, assign at least one Engine Company to the LZ and designate an "LZ Sector." LZ Sector will keep track of patient destination, communicate landing instructions with incoming and outgoing aircraft and enforce established safety standards for landing zones (Brush Fire Air Support.)

It may be necessary to use ambulances or other vehicles to carry patients from the treatment area to the landing zone. Helicopters should be used to transport critical patients to more distance medical facilities, allowing closer hospitals to receive patients by ground ambulance.

**PHOENIX REGIONAL
STANDARD OPERATING PROCEDURES**

TRANSPORTATION SECTOR

M.P. 203.05

03/00-R

Page 2 of 2

Transportation should also determine a suitable location next to Treatment to establish a patient loading area. Rescues should be staged off site and brought in to the loading area as needed, no more than two at a time. Transportation must coordinate closely the preparation of patients with Treatment and have rescues and ambulances immediately ready in the loading area. Transportation should aggressively seek patients from Treatment and have two rescues or ambulances in the loading area at all times. These rescues should have a separate entry and exit point into the loading area to eliminate the need to back ambulances.

Transportation Sector must ensure that contact with appropriate medical facilities is accomplished as soon as possible to determine individual hospital capabilities to receive patients. Hospitals should be advised of the location and type of incident, along with the triage report indicating the number of patients, nature (e.g., trauma, burns, medical), and the severity of their injuries. Transportation should initiate medical facility inventory by contacting the Dispatch Center on Med-9 early during the incident.

Treatment Sector will normally advise Transportation when patients are ready for transport,. Transportation will allocate patients to medical facilities according to patient injury and priority, hospital capacity and specialty (pediatric, burns, Level I Trauma,etc.).

Transportation of IMMEDIATE patients will receive priority followed by the transport of DELAYED and MINOR patients. If needed, transport of MINOR patients to a medical facility may be accomplished by using city busses or vans. In general, it is preferred to "leap-frog" MINOR patients to distant hospitals to minimize transport times for DELAYED patients to closer facilities.

Personnel assigned to Transportation will remove patients from the treatment area and deliver them to the selected rescues or other transport units (vans, buses, etc.). Treatment and Transportation Sectors must maintain close coordination to determine the most appropriate allocation for each patient.

Prior to transport, the Transportation Sector Officer (or designee) will remove a transportation tracking slip from each triage tag and write in the transport unit and hospital destination on the slip. These tracking slips are kept by Transportation to maintain an accounting of all patients leaving the scene. They can also be verified by Command, who has the initial triage tracking slips.

When rescues or helicopters have left the scene, Transportation should advise the Dispatch Center on Med-9 of the estimated arrival time and patient status (e.g., "*Rescue 9 is enroute to Good Samaritan, ETA of 5 minutes, with one IMMEDIATE patient.*"). The Dispatch Center will relay this information to the appropriate medical facility.

Rescue personnel will have the responsibility to perform a courtesy notification to the receiving hospital, indicating their estimated arrival time, the number and type of patients on board, along with a brief description of their injuries. *ALS personnel should operate under Standing Orders and not patch for Medical Direction unless necessary.*

When all IMMEDIATE patients have been transported from the scene, Transportation should notify Command. A declaration by Command to Dispatch of "All IMMEDIATES Transported" is an EMS tactical benchmark.

**PHOENIX REGIONAL
STANDARD OPERATING PROCEDURES
TRANSPORTATION SECTOR BRANCH
Multiple Site Coordination
M.P. 203.05A 03/00-R Page 1 of 2**

In large, complex medical incidents, it may be necessary to coordinate the transport of patients from two or more treatment areas simultaneously. This may require the creation of a Transportation Branch and the assignment of a Transportation Branch Director to coordinate transportation functions for all of the treatment locations.

Transportation Branch has the following responsibilities:

- Ensure the functions of transportation are carried out.
- Supervise and coordinate the transportation functions and personnel assigned.
- Determine/request resource needs to Command.
- Communicate direction to tactical units (sectors)
- Ensure units are completing objectives.
- Maintain incident documentation.

The following represents the standard operations that will be performed by the Transportation Branch:

1. Coordinate the assignment of rescues from Staging area to various sectors (e.g., East Transportation, West transportation, LZ).
2. Determine hospital availability status through Dispatch on Med-9.
3. Coordinate all patient allocation and hospital destination.
4. Coordinate the movement of patients from treatment areas to Rescue loading areas or helicopter landing zone.
5. Maintain an accounting of all patients and patient destinations.
6. Ensure the safety and accountability of all assigned personnel.
7. Provide frequent progress reports to Command.
8. Notify hospital (through Dispatch) of estimated arrival time of specific rescues or helicopters.
9. Notify Command when all IMMEDIATE patients have been transported.

The Transportation Branch Director will be stationed at a central location, preferably at or close to the Command Post. Transportation Sector personnel will be assigned to each treatment area as well as at Staging and at the Helicopter Landing Zone. The Transportation Branch Director will coordinate all of these assignments and assign the necessary resources. Each Sector (e.g., "East Transportation Sector," "West Transportation Sector," "Staging," "LZ") will require at least one full company.

Due to the complexity of this operation, a separate radio channel should be assigned exclusively to the Transportation Branch. This will facilitate the amount of communications necessary between the Branch Director and the assigned Sector officers at each location. The Transportation Branch Director will handle all communications with Dispatch (on Med. 9 or any other channel assigned by Dispatch).

The Transportation Sector personnel in each location will communicate their transportation needs directly to the Transportation Branch Director to obtain resources. The Transportation Branch Director will then direct Staging to assign one or more rescues to a specific loading area.

When a rescue or ambulance is ready for loading, the Sector officer should advise Transportation Branch of the number of patients being loading into a rescue and their severity. The Branch Director will then advise the Transportation Sector officer of the destination hospital. This Sector officer will advise the rescue personnel of their hospital destination. The Transportation Branch will advise receiving hospitals of patients enroute, their triage status, and provide an ETA.

**PHOENIX REGIONAL
STANDARD OPERATING PROCEDURES
TRANSPORTATION SECTOR BRANCH
Multiple Site Coordination
M.P. 203.05A 03/00-R Page 2 of 2**

Each Transportation Sector officer will also remove a transportation tracking slip from the triage tag of each patient and write in the transport unit and hospital destination. Other information (name, age, injuries) can be completed on the tracking slip as time permits. These tracking slips are kept by Transportation Sector officers to maintain an accounting of all patients leaving the Sector. They can also be verified by Command, who has the initial triage tracking slips.

The Transportation Branch Director will assign necessary resources to the Helicopter Landing Zone to move patients from the treatment areas over to LZ. This may require the use of a rescue. Helicopters should be used to transport IMMEDIATE patients to more distant appropriate medical facilities.

The Transportation Sector personnel assigned to each Treatment Area will perform the same function as established for an incident with a single treatment area. The Transportation Sector officer functions as a coordinator and resource allocator, consolidating communications with Dispatch and Command.

**PHOENIX REGIONAL
STANDARD OPERATING PROCEDURES**

MEDICAL SUPPLY SECTOR

M.P. 203.06

03/00-N

Page 1 of 1

Medical Supply Sector

Major incidents rapidly consume standard complements of medical supplies carried by fire companies. Since, large multi-casualty incidents (MCIs) require a significant amount of EMS supplies and generate large quantities of biohazard waste, additional supplies must be obtained and delivered to the site.

To improve the fire department's capability to treat patients arising from a large-scale multiple patient incident, a Medical Supply Sector shall be established during all 3-Alarm Medical (or greater) major medical incidents using a minimum of one fire company. Additionally, Dispatch will special call Medical Support 19 from the airport and an EMS supply truck from Resource Management to the scene.

The Medical Supply Sector will be staffed with members from the assigned fire company, the personnel assigned to MS19, and the EMS supply truck, with the company officer assigned as the Medical Supply Sector Officer. A second EMS supply truck and a second adaptive response unit will be dispatched to the scene following an upgrade to a 4-Alarm Medical incident.

The Medical Supply Sector should be established in close proximity to the treatment area. At expanded incidents, the Medical Supply Sector may be assigned to the Logistics Section.

At incidents with less than 20 patients, Medical Supply Sector will report to Command. At larger mass casualty incidents, this Sector will report to Medical Branch or Logistics Section.

Capabilities

The Medical Supply Sector will provide the following to other sectors as needed:

- Provide EMS supplies (triage tags, IVs, backboards, trauma supplies, gloves, goggles, masks, etc.).
- Provide biohazard supplies (biohazard trash containers, biohazard plastic bags, sharps containers, etc.)
- Provide oxygen refill.
- Set up an oxygen manifold.
- Obtain needed offsite supplies

**PHOENIX REGIONAL
STANDARD OPERATING PROCEDURES**

MEDICAL SAFETY OFFICER

M.P. 203.06A

10/04-N

Page 1 of 2

Purpose

The position of the Medical Safety Officer (MSO) would place a licensed medical practitioner as part of the strategic level to enhance the medical wellness issues associated with our workforce. The MSO would be assigned to work for the Safety Section.

MSO's would be better positioned to provide the Command Team with strategic information related to triage, treatment, and transportation of our firefighters to specialty hospitals and state-of-the-art practices. This would decrease processing time for our firefighters' as prearrangement for direct admission would be in place.

This position would also enhance the Command Team at multiple-casualty WMD incidents with regard to customer health issues and appropriate triage.

The information provided by the MSO would also benefit the PIO function with accurate information from a licensed medical practitioner at the scene, as well as liaison work with outside agencies that have statutory responsibilities on these types of events.

With on-scene coordination, our firefighters would benefit with follow-through and follow-up care from the hospital back through the Health Center.

Objective

The MSO would respond to specialty alarms, multi-alarms, and long-term campaign events. The MSO would be tasked through the Safety Section and work in the Rehab Sector. The MSO would be partnered with a Command Officer to complete all tasks. This in turn would assist the Command Team in working through the strategic/tactical priorities of rapidly escalating incidents.

Functions

- Provide Command with clinical level information to enhance decisions concerning firefighter medical safety at a strategic/tactical level.
- Provide firefighters with real-time monitoring (instruments) by modifying work/rest cycles.
- Medical Safety Officer (MSO) would function as a Medical SO (Support Officer) assigned to the Safety Section to clinically direct medical treatment, triage, and release of firefighter at the scene.
- Medical Safety Officer (MSO) if needed would function as a Medial Triage Officer at multiple-casualty, WMD incidents, assigned to the Operations Section.
- Would act as coordinator/controller for the specialty hospital care through Occupational Health with Banner Poison Control Center, as well as Health Center follow through.

Requirements

- Physician/Licensed Medical Professional functional with firefighter occupational medicine and ACLS protocol, local medical specialties location.
- Demonstrate knowledge, skills need to work within ICS through simulation at the Command Training Center (CTC).

**PHOENIX REGIONAL
STANDARD OPERATING PROCEDURES**

MEDICAL SAFETY OFFICER

M.P. 203.06A

10/04-N

Page 2 of 2

- Demonstrate basic radio order model protocols.
- Demonstrate knowledge of start system through drills, simulation.

Equipment

- Text Pager
- Identification vest /PPE
- Laptop for on-scene access to medical records
- Radio/cellular phone
- Staff vehicle
- Associated medical equipment

Deployment

This position would deploy to multi-alarms/multi-hazard/WMD incidents through automatic dispatch or by request from Command.

Behavioral Outcomes

The Medical Safety Officer operating on the emergency scene, as part of the Command Team will offer consistency in decisions related to firefighter wellness:

- Decrease risk factor for firefighter deaths related to cardiac emergencies while operating on the emergency scene.
- Decrease risk factor for serious heat related injuries for firefighters with a more positive outcome for recovery and loss time.
- Decrease the lost time for firefighter in relation to industrial injuries with the highest level of triage, management, and early intervention at the scene of injury.
- Quick identification of trends in relation to civilian (or firefighter) illness during suspected mass casualty incidents in relation to the use of Nuclear, Biological, or Chemical agents.
- Provides opportunity to gather consistent and valuable statistical information to be used for better management decisions with an increased opportunity for successful grants and other alternative funding avenues.

**PHOENIX REGIONAL
STANDARD OPERATING PROCEDURES**

HAZARDOUS MATERIALS
M.P. 204.01 04/98-R Page 1 of 6

This plan provides a basic philosophy and strategic plan for hazardous materials situations. All Phoenix Fire Department Standard Operating Procedures, unless superseded by a specific part of this plan, remain in effect for Hazardous Materials incidents.

Hazardous Materials incidents encompass a wide variety of potential situations including fires, spills, transportation accidents, chemical reactions, explosions and similar events. Hazards involved may include toxicity, flammability, radiological exposure, corrosives, explosives, health, and chemical reactions or a combination of factors. This plan provides a general framework for handling a hazardous materials incident, but does not address the specific tactics or control measures for particular incidents.

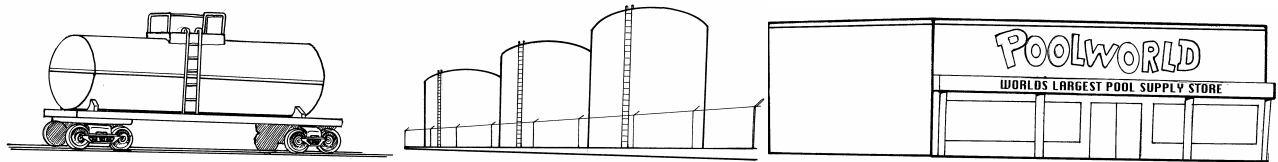

Every incident presents the potential for exposure to hazardous materials; even the products of combustion of an ordinary fire may present severe hazards to personnel safety.

This procedure is specifically applicable to known hazardous materials incidents, but it does not reduce the need for appropriate safety precautions at every incident. The use of **FULL PROTECTIVE CLOTHING AND SCBA AS WELL AS SPECIAL PROTECTIVE CLOTHING** and the use of all Standard Operating Procedures on a continuing basis are foundational for this plan.

Dispatch

The Dispatch Center will attempt to obtain any and all information from the person reporting a hazardous materials incident. The information should, if possible, include material name and/or type, amount and size of container(s), problem (leak, spill, fire, etc.) and dangerous properties of the materials **AS WELL AS THE NUMBER OF PERSONS INJURED OR EXPOSED**. The incident taker should remain on the telephone with the caller to gain additional information after entering the call for dispatch.

Any additional information shall be relayed to responding units after dispatch. **THIS SHOULD INCLUDE THE SAFEST APPROACH OR BEST ACCESS TO THE INCIDENT IF AVAILABLE.**

If the call comes from a person with particular knowledge of the hazardous situation, that person **SHOULD BE INSTRUCTED TO** meet and direct the arriving units. Dispatch shall relay that person's location and level of knowledge to responding units.

**PHOENIX REGIONAL
STANDARD OPERATING PROCEDURES**

HAZARDOUS MATERIALS

M.P. 204.01 04/98-R Page 2 of 6

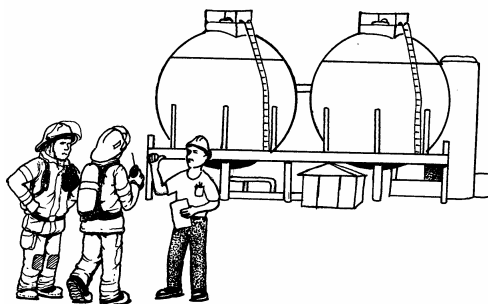

The Dispatch Center will dispatch the APPROPRIATE Hazardous Materials Assignment COMPANIES to all reported hazardous materials incidents.

Dispatch will inform units as to the prevailing wind speed and direction from the monitoring station NEAREST THE INCIDENT and advise responding units.

FIRST ARRIVING UNIT

The first arriving officer will establish Command and begin a size-up. The first unit must consciously avoid committing itself to a dangerous situation. When approaching, slow down or stop to assess any visible activity taking place. Evaluate effects of wind, topography and location of the situation. Route any other responding companies away from any hazards.

Command should consider ESTABLISHING LEVEL II STAGING WHENEVER POSSIBLE FOR OTHER RESPONDING UNITS. STAGED COMPANIES MUST BE in a safe location, taking into account wind, spill flow, explosion potential and similar factors in any situation. THE DOT GUIDEBOOK, NFPA REFERENCE MATERIALS, the NIOSH POCKET GUIDE, OR ANY OTHER MATERIAL SUCH AS MSDS OR SHIPPING PAPERS AVAILABLE TO THEM SHOULD BE USED TO ESTABLISH A SAFE DISTANCE FOR STAGING.

SIZE-UP

Command must make a careful size-up before making a commitment. It may be necessary to take immediate action to make a rescue or evacuate an area. This should be attempted only after a risk/benefit analysis is completed. Personnel must take advantage of available personal protective equipment in these situations.

**PHOENIX REGIONAL
STANDARD OPERATING PROCEDURES**

HAZARDOUS MATERIALS

M.P. 204.01 04/98-R Page 3 of 6

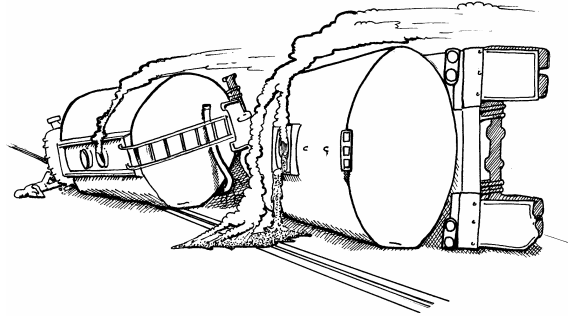

The objective of the size-up is to identify the nature and severity of the immediate problem and to gather sufficient information to formulate a valid action plan. Hazardous materials incidents require a cautious and deliberate size-up.

Avoid premature commitment of companies and personnel to potentially hazardous locations. Proceed with caution in evaluating risks before formulating a plan and keep uncommitted companies at a safe distance. **IN MANY CASES, EVALUATION BY HAZARDOUS MATERIALS TEAM MEMBERS BEFORE COMMITTING IS THE SAFEST APPROACH.**

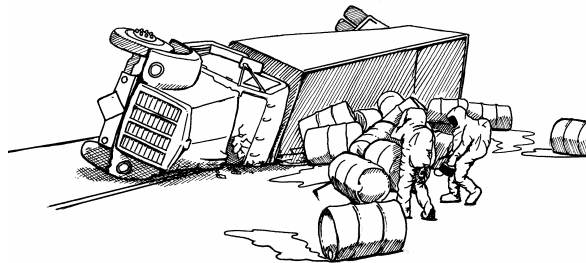

Identify a hazardous area based on potential danger, taking into account materials involved, time of day, wind and weather conditions, location of the incident and degree of risk to unprotected personnel. Take immediate action to evacuate and/or rescue persons in critical danger, if possible, providing for safety of rescuers **FIRST**.

The primary objective is to identify the type of materials involved in a situation, and the hazards presented, before formulating a plan of action. Look for labels, markers, DOT IDENTIFICATION NUMBERS, NFPA DIAMOND or shipping papers, etc. Refer to pre-fire plans, and ask personnel at the scene for additional information (plant management, responsible party, truck drivers, fire department specialist). Use reference materials carried on apparatus and have Dispatch contact other sources for assistance in sizing up the problem (state agencies, fire department specialists, manufacturers of materials, etc.).

**PHOENIX REGIONAL
STANDARD OPERATING PROCEDURES**

HAZARDOUS MATERIALS
M.P. 204.01 04/98-R Page 4 of 6

ACTION PLAN

Based on the initial size-up and any information available, Command will formulate an action plan to deal with the situation.

THE ACTION PLAN MUST PROVIDE FOR:

1. Safety of all fire personnel
2. Evacuation of endangered area, if necessary
3. Control of situation
4. Stabilization of hazardous materials, and/or
5. Disposal or removal of hazardous material

Most hazardous materials are intended to be maintained in a safe condition for handling and use through confinement in a container or protective system. The emergency is usually related to the material escaping from the protective container or system and creating a hazard on the exterior. The strategic plan must include a method to control the flow or release, get the hazardous material back into a safe container, neutralize it, allow it to dissipate safely, or coordinate proper disposal.

The specific action plan must identify the method of hazard control and identify the resources necessary to accomplish this goal. It may be necessary to select one method over another due to the unavailability of a particular resource or to adopt a "holding action" to wait for needed equipment or supplies.

Avoid committing personnel and equipment prematurely or "experimenting" with techniques and tactics. Many times it is necessary to evacuate and wait for special equipment or TECHNICAL help.

As a general policy, the Hazardous Materials Team will respond to any situation where a private contractor is required to clean-up hazardous materials.

CONTROL OF HAZARDOUS AREA

A hazardous material incident has two initial zones associated with the scene, similar to a fire. There are the LIMITED ACCESS ZONE and the EVACUATION ZONE.

**PHOENIX REGIONAL
STANDARD OPERATING PROCEDURES**

HAZARDOUS MATERIALS
M.P. 204.01 04/98-R Page 5 of 6

LIMITED ACCESS ZONE (LAZ)

The LAZ is the area in which personnel are potentially in immediate danger from the hazardous condition. This is established by Command and controlled by the Fire Department. Access to this area will be rigidly controlled and only personnel with proper protective equipment and an assigned activity will enter. All companies will remain in tact in designated staging areas until assigned. Personnel will be assigned to monitor entry and exit of all personnel from the LAZ. The LAZ should be geographically described to all responding units, if possible and identified by yellow fireline tape. (A Lobby Control Sector will be established to control access to the LAZ and maintain an awareness of which personnel are working in the area.)

- Establish a safe perimeter around hazardous area and identify with Hazard Zone tape.
- Request adequate assistance to maintain the perimeter.
- Identify an entrance/exit point and inform Command of its location.
- Coordinate with Haz Sector to identify required level of protection for personnel operating in the Hazard Zone.
- Collect/return accountability PASSPORTS of all companies entering/leaving the controlled area.

Restriction of personnel access into the LAZ includes not only Fire Department personnel, but any others who may wish to enter the L. A. Zone (Police, press, employees, tow truck drivers, ambulance personnel, etc.). Command is responsible for everyone's safety.

EVACUATION ZONE (EZ)

The EZ is the larger area surrounding the LAZ in which a lesser degree of risk to personnel exists. All civilians would be removed from this area. The limits of this zone will be enforced by the Police Department based on distances and directions established in consultation with Command. The area to be evacuated depends on the nature and amount of the material and type of risk it presents to unprotected personnel (toxic, explosive, etc.).

In some cases, it is necessary to completely evacuate a radius around a site for a certain distance (i.e., potential explosion).

In other cases, it may be advisable to evacuate a path downwind where toxic or flammable vapors may be carried (and control ignition sources in case of flammable vapors).

Reference: Evacuation Sector, Police Liaison Sector)

NOTE: When toxic or irritant vapors are being carried downwind, it may be most effective to, (shelter in place), keep everyone indoors with windows and doors closed to prevent contact with the material instead of evacuating the area. In these cases, companies will be assigned to patrol the area assisting citizens in shutting down ventilation systems and evacuating persons with susceptibility to respiratory problems.

**PHOENIX REGIONAL
STANDARD OPERATING PROCEDURES**

HAZARDOUS MATERIALS
M.P. 204.01 04/98-R Page 6 of 6

In all cases, the responsibility for safety of all potentially endangered citizens rests with Command. Once the Hazardous Materials Sector has been established, Haz Mat personnel will define and establish a hot, warm and cold zone. These zones will remain in effect for the remainder of the incident.

USE OF NON-FIRE DEPARTMENT PERSONNEL

In some cases, it may be advantageous to use non-Fire Department personnel to evaluate hazards and perform certain functions within their area of expertise.

When such personnel are outfitted with breathing apparatus, chemical suits, etc., they must be made aware of the functions, limitations and safety precautions necessary in their use. Fire Department personnel with the necessary protective equipment must closely monitor and/or accompany such personnel for safety.

BE AWARE THAT COMMAND IS RESPONSIBLE FOR THE SAFETY OF ALL PERSONNEL INVOLVED IN ANY INCIDENT.

PHOENIX REGIONAL STANDARD OPERATING PROCEDURES

HAZARDOUS MATERIALS EVACUATION

M.P. 204.01A

11/96-R

Page 1 of 8

An incident involving hazardous materials has a higher probability of causing an evacuation of an affected area than any other incident. By the very nature of the hazard, this type of evacuation often provides very little preparation time. Decisions will need to be made quickly, and citizens moved rapidly.

This procedure identified the method and resources required to execute a small to large scale evacuation.

Levels of Evacuation

Experience has reflected three levels of evacuation. Each requires a different resource commitment. They include: Site Evacuation, Intermediate Level Evacuation, and Large Scale Evacuation

Site Evacuation

Site evacuation involves a small number of citizens. This typically includes the workers at the site, and persons from adjacent occupancies or areas. The citizens are easily evacuated and collected upwind at the perimeter area. Evacuation holding times are typically short, generally less than an hour or two, and citizens are permitted to return to their businesses or homes.

Intermediate Level Evacuation

The next level, or intermediate level, involves larger numbers of citizens and/or affects a larger area. This level affects off-site homes and businesses and normally affects fewer than 100 persons. Persons may remain out of the area for two to four hours or more. Evacuation completion times will be somewhat longer, but generally rapid. Collecting, documenting, and controlling the evacuees becomes more difficult. Off-site collection sites or shelter areas will need to be determined and managed. Some evacuees will leave the area on their own or be sent home by employers. Site perimeters become larger and perimeter security requires more resource. Close coordination with the Police Department and other agencies will be required.

Large Scale Evacuation

A large or concentrated release of a hazardous substance may cause a large off-site evacuation. Thousands of citizens could be evacuated. Rapid initiation of the evacuation process may be required. Evacuees may be out of their homes and businesses for many hours if not days. Evacuation completion time frames will be extended. Evacuation shelters will need to be located, opened and managed. Documentation and tracking of evacuees becomes more important as well as more difficult to manage. Very close coordination with the police and multiple agencies will be required. Site and evacuation perimeters become extended and require much more resources to maintain. Security of the evacuated area becomes a concern. In most cases, the City's Emergency Operations Center (EOC) will be opened to support the evacuation and site operations.

PHOENIX REGIONAL STANDARD OPERATING PROCEDURES

HAZARDOUS MATERIALS EVACUATION

M.P. 204.01A

11/00-R

Page 2 of 8

Time Factor Considerations

Time factors are also an important consideration in the evacuation decision.

A rapidly developing moving toxic cloud will demand a more immediate size-up and quick decision making. Such forced speed of decision making often is made with less information than a slow moving event. Accuracy of information will also be limited.

The speed of the developing hazard will dictate the speed of evacuation. Immediate evacuation will require more resources than a slower developing event.

It will take time to complete the evacuation. The more people to be evacuated, and the distance between the occupancies to be evacuated, the more time required. The greater numbers needing evacuation will also require a greater resource commitment.

Decision to Evacuate

The decision to evacuate needs to be considered quickly and early. Delays in initiating evacuations can expose greater numbers of the public to the hazardous product. An unnecessary evacuation should be avoided. However, once the hazard has been identified and verified, the process of deciding who, when, and how to evacuate should proceed quickly.

In some cases, in-place sheltering (staying indoors) may provide adequate protection and should be a serious consideration in the decision making process.

Factors to consider when evaluating the evacuation need include:

- Product Toxicity (as a health hazard)
- Concentrations (before it becomes a health hazard)
- Length of Time Exposed
- Weather Conditions (temperature, humidity)
- Wind Direction (direction, speed)
- Wind Changes
- Predicted Weather Changes
- Distances From Site Requiring Evacuation
- Evacuation Risk to Public (bringing them outdoors)
- Infiltration Into Buildings
- Shelter Locations
- Transportation Needs and Availability
- Evacuation Time Factors
- Resources Required for Evacuation
- Concentrations of the population in the area

PHOENIX REGIONAL STANDARD OPERATING PROCEDURES

HAZARDOUS MATERIALS EVACUATION

M.P. 204.01A

11/00-R

Page 3 of 8

In some situations, in-place sheltering can be used to protect the public rather than to initiate an evacuation. In-place sheltering can be considered during the following circumstances:

- The hazardous material has been identified as having a low or moderate level health risk.
- The material has been released from its container and is now dissipating.
- Leaks can be controlled rapidly and before evacuation can be completed.
- Exposure to the product is expected to be short-term and of low health risk.
- The public can be adequately protected by staying indoors.

Command may need to provide instructions to the affected public regarding the need to stay indoors and in such protective measures as shutting down their evaporative cooling systems, and sealing their buildings.

Command Organization

Once Command has determined evacuation to be necessary, adequate resources need to be called to the scene and appropriate agencies notified to respond. A central staging area for all agencies should be considered.

The Incident Command Organization will need to be expanded to include other Sections/Branches. This level of Command structure may need to be implemented to more effectively manage a large scale incident. Sections/Branches to be considered include:

- Public Information Sector
- Geographic Sectors (Multiple Sectors)
- Police Liaison Sector
- Staging Sector
- Transportation Sector
- Police Resource
- Shelter Sectors
- Other Agency Liaison Sectors
 - a. Operations Section
 - b. Administrative Section
 - c. Planning Section
 - d. Logistics Section
- Evacuation Branch/Sector

PHOENIX REGIONAL STANDARD OPERATING PROCEDURES

HAZARDOUS MATERIALS EVACUATION

M.P. 204.01A

11/00-R

Page 4 of 8

Command Responsibilities

Command's responsibilities include the following items:

- Rapidly size up the situation to determine the need to evacuate.
- Determine evacuation perimeters.
- Determine the number and location of shelter sites and communicate the locations to the command organization. (Use the CAD INFO SHELTERS or the Red Disaster Operations Manual for shelters and maps.)
- Order evacuation.
- Provide resources required.
- Establish Police liaison.
- Order the alert of other appropriate agencies.
- Expand the command organization to meet the incident/evacuation needs.
- Establish an evacuation plan and communicate the plan to sectors and agency liaisons.
- Monitor, support, and revise the evacuation process as necessary.
- Evacuate persons from the area of greatest danger first.
- Assign specific areas to evacuate in order to avoid duplication or missed areas [use Fire Department map book--either page numbers (i.e., NE0107) or hydrant zone numbers as grids].
- Provide the transportation necessary for evacuees.
- Provide continuing command of the evacuation, de-commitment, and return of evacuees.

Police Responsibilities

The Police Department will be an integral part of the evacuation process, as a large portion of the evacuation may be accomplished by police officers. Police responsibilities include:

- Provide a ranking officer to the incident command post.
- Provide a ranking officer to the Evacuation Sector/Evacuations Branch.
- Provide a communication system for police resources.
- Provide police resources needed for evacuation.
- Provide traffic control and traffic routing.
- Provide perimeter security.
- Provide evacuation zone security.

Dispatch Center's Responsibilities

- Dispatch appropriate resource as requested.
- Notify appropriate Fire and City officials.
- Notify the appropriate support agencies as requested or listed in standard operating procedures.
- Notify the Administrative Duty Officer and provide a status report.
- Initiate recall of additional Dispatch personnel to meet the demands of the incident.
- Notify the City telephone switchboard operator and provide the operator a status report. Update the operator as needed.
- Notify the hospitals in the area of evacuation (both those exposed and not exposed) and provide a status report and updates as needed (intermediate and large scale evacuations).

PHOENIX REGIONAL STANDARD OPERATING PROCEDURES

HAZARDOUS MATERIALS EVACUATION

M.P. 204.01A

11/00-R

Page 5 of 8

Public Information Officer's Responsibilities

- Notify the news media and provide status reports and updates as necessary.
- Provide the media with consistent and accurate evacuation instructions as provided by Command or the Evacuation Branch/Sector.
- Utilize the media and coordinate evacuation notices through news media.

Red Cross Responsibilities

Once long term sheltering is identified, the Red Cross will open and manage shelters. Early notification is required. The Red Cross will need up to three hours to get adequate personnel, equipment and supplies to the shelter sites.

Some Fire Department resources may need to be committed to the shelters, particularly in the area of initial opening and staffing by a shelter crew, and later for potential emergency medical support.

Evacuation Branch/Sector Responsibilities

An Evacuation Branch/Sector must be established. On large-scale evacuations, Evacuation Branch should have a separate radio channel. Various sub-level sectors would also need to be established and report to Evacuation Branch.

Typically a large commitment of police officers will be required to accomplish an evacuation. The Evacuation Branch officer must obtain a ranking police officer at his/her location in order to closely coordinate evacuation efforts. An appropriate commitment of police resource must be obtained. Evacuation responsibilities include:

- Obtain resource needed to evacuate.
- Obtain ranking police officer for liaison.
- Establish sectors as needed.
- Provide sectors objectives and specific areas to evacuate (use Fire Department map pages or hydrant zones in Fire Department map book for grids).
- Provide sectors with shelter location and instructions.
- Provide sectors with evacuation instruction pads.
- Provide sectors with private vehicle routing instructions (out of the area).
- Obtain/provide buses or other transportation to those requiring transportation out of the area. (For large scale evacuation, start with two buses and request more as needed.)
- Evacuate those at greatest risk first.
- Evacuate the greatest concentrated areas next (i.e., apartment complex).
- Consider individual sectors for large population occupancies (i.e., multi-story buildings, large apartment complexes, schools, etc.).
- As individual geographic or grid sectors complete their evacuations, terminate the sector identity and reassign resources to other developing sectors (for large scale evacuation).
- Closely document and maintain records of the evacuation process to avoid duplication or missed areas.
- Document those addressees refusing to leave.

PHOENIX REGIONAL STANDARD OPERATING PROCEDURES

HAZARDOUS MATERIALS EVACUATION

M.P. 204.01A

11/00-R

Page 6 of 8

On-Site Notification to Evacuate

Door-to-door notification is time-consuming. In many cases, adequate resources and time is not available to do this type of face-to-face notification. Use of sirens, air horns and PA systems will speed the alert process.

When making door-to-door evacuations:

- Be in uniform.
- Wear your helmet.

Face-to-face notification should include the following instructions:

- There's been a hazardous materials incident.
- You are in danger.
- Leave immediately.
- Go to the shelter (location).
- Take () route out of area.
- Do you need transportation?
- Provide the customer with evacuation instructions.

Take the following items:

- Wallet/purse
- House & car keys
- Money
- Eye glasses
- Medications
- Proper clothing
- Pets

In other situations, where immediate and rapid evacuation makes door-to-door notification impossible, use the following notification method:

- Use 3 five-second blasts of the siren while on the "YELP" setting.
- Followed by the standard evacuation instruction over PA system (see instructions above)
- Use maximum volume on PA system.
- Proceed slowly to maximize notification.
- Initiate notification at the beginning of each block and each 50 yards after that.

Once each assigned grid of objectives is complete, report completion to the Evacuation Branch/Sector officer.

Refusal to Leave

Some citizens may refuse to leave. A few methods of persuasion to leave include:

- Be in uniform.
- Wear your helmet.
- Wear SCBA and facepiece (air hose may not need to be connected) when advising the citizen to leave.

PHOENIX REGIONAL STANDARD OPERATING PROCEDURES

HAZARDOUS MATERIALS EVACUATION

M.P. 204.01A

11/00-R

Page 7 of 8

- Ask for next of kin and a phone number.
- Write the next of kin information down.

Evacuations follow somewhat of a triage philosophy--we'll evacuate the greatest number for the greatest benefit. Individual refusals will be left to fend for themselves. There simply may not be enough time or resources to initiate forced removal of persons from their homes. However, documentation of the refusal should be done. Write the address down (or if radio traffic permits, radio the address to the Evacuation Branch/Sector officer).

Transportation Sector Responsibilities

A Transportation Branch/Sector should be a priority consideration for any intermediate or large-scale evacuation. Not all citizens will have a vehicle available to them.

- Obtain buses (start with minimum of two) and other vehicles that can be used for transportation.
- Stage all transportation resources.
- Put one firefighter (or police officer) with a radio on each vehicle equipped with a Fire or Police Department radio.
- Coordinate with Evacuation Branch/Sector the pick-up points or addresses of those citizens needing transportation.

On-Duty Deputy

Any time more than ten (10) persons are evacuated, the Duty Deputy advises the City Manager, or his/her designee, of the situation.

If the Duty Deputy cannot respond to the incident or is delayed, the Duty Deputy will need to contact the incident command staff for a status report. Command should be prepared to respond to this request via cellular telephone, etc.

Emergency Operations Center (EOC) Operations

If a significant or major evacuation occurs, the City's Emergency Operations Center (EOC) will go into operation. The EOC will collect department heads and senior staff from the Fire, Police, City Manager's Office, Public Works, and other City departments to the EOC. The EOC's objective is to use the City's resources to support the incident operations and evacuations.

Command should be prepared for this support and potential policy direction in regards to the incident and evacuation operations.

If the EOC is in operation, Command must assign an EOC liaison as part of the Command Organization. The EOC Liaison must have a radio communications link (another radio channel) with the EOC and a cellular telephone link. If the EOC has a CAD Terminal, the EOC liaison will need access to an MDT. (The MDT and cellular phones are available in any Battalion vehicle and some staff vehicles.)

PHOENIX REGIONAL STANDARD OPERATING PROCEDURES

HAZARDOUS MATERIALS EVACUATION

M.P. 204.01A

11/00-R

Page 8 of 8

Responsibilities of the EOC Liaison Officer are:

- Obtain a radio communications link with the EOC (through Dispatch Center on a separate channel).
- Obtain a cellular telephone or other communication link with the EOC.
- Obtain an immediate status report from Command and provide that report to the EOC fire officer.
- Provide an immediate report to the EOC on any changes in plans, strategy, problems encountered, etc.
- Provide progress reports every 30 minutes unless the EOC requires more frequent or less frequent reports.
- Act as the communication link from EOC to Command.
- Provide Command with direction, policy information, etc. that is communicated from the EOC.

The EOC will remain in operation for the duration of the evacuation. Command will maintain an EOC liaison and a communication link with the EOC throughout the evacuation, including de-commitment and return of evacuees.

Return Evacuees

The decision to return evacuees to their homes will be the sole responsibility of the Fire Department Incident Commander. If the EOC is operating, the decision to return evacuees will be made by the EOC staff. No other City agency will be authorized to order the return.

Returning evacuees may require transportation. A Transportation Branch/Sector may need to be reactivated to provide for these needs.

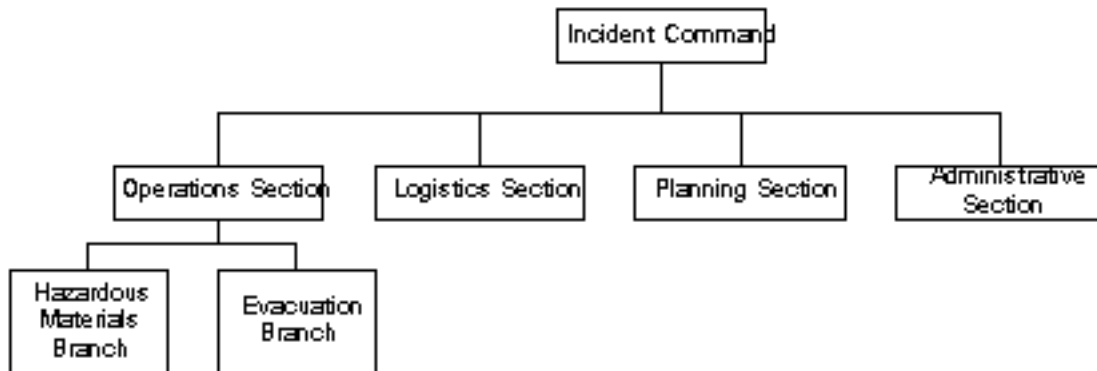

PHOENIX REGIONAL
STANDARD OPERATING PROCEDURES

Hazardous Materials Decontamination

M.P. 204.01B

04/18

Page 1 of 5

Purpose

The purpose of the Decontamination Procedure is to assure that any potentially harmful or dangerous residues on persons, equipment or apparatus are confined within the Hot Zone. Decontamination is intended to prevent the spread of contaminants beyond the already contaminated area, including the fire station, the hospital, and other environments.

Procedure

The specific measures required to decontaminate personnel, equipment, or apparatus will vary with the contaminant, the circumstances and the level of contamination. These factors must be considered on a case-by-case basis, within the guidelines described in this procedure.

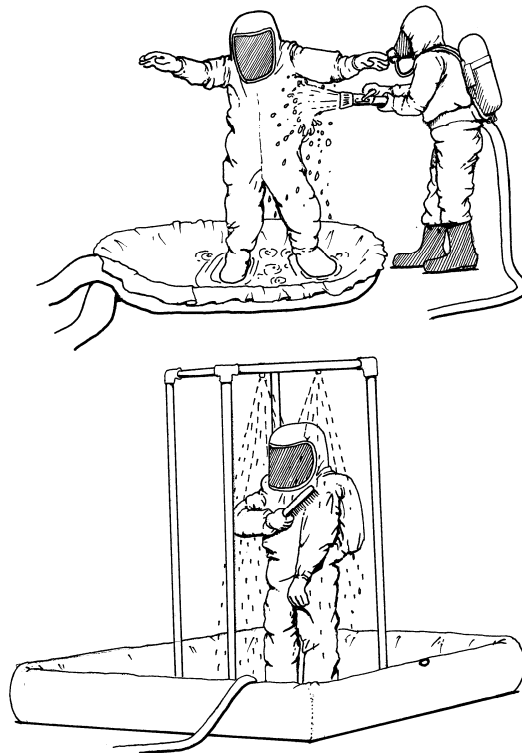

Command is responsible for assuring that a Decontamination Sector is implemented at incidents which involve a potential contamination problem. This sector should be assigned to personnel from the Hazardous Materials Team. Decontamination must be integrated into the management plan of the hazardous materials incident.

**PHOENIX REGIONAL
STANDARD OPERATING PROCEDURES**

Hazardous Materials Decontamination

M.P. 204.01B

04/18

Page 2 of 5

The Decontamination Sector Officer is responsible for determining the most appropriate decontamination procedures and managing the decontamination process. This should be done in conjunction with advice from the Poison Control Center.

The initial assessment of decontamination requirements must be based upon the specific needs of the situation. The decontamination process must be appropriately designed for the specific materials involved and the degree and type of exposure encountered. The assessment will require research and may involve consultation with toxicology resources.

The Decontamination Sector Officer must assume that all personnel and equipment preparing to leave the Hot Zone are contaminated. Three courses of action are available:

1. Confirm not contaminated by using instruments or investigation based on the nature of the situation.
2. Decontaminate (as appropriate to the situation) and release.
3. Retain and package items for removal from the site for disposal or decontamination at a different location.

In all cases, the primary objective must be to avoid contaminating anyone or anything beyond the Hot Zone. When in doubt about contamination, decontaminate all affected personnel, equipment, and apparatus.

The Decontamination Area should be established within the Hot Zone perimeter adjacent to the Entrance/Exit (Lobby Control). Personnel, equipment and apparatus shall not be permitted to leave the Hot Zone without approval from the Decontamination Sector Officer.

The Decontamination Area should provide a corridor leading away from the source of contamination toward the Exit, with stations along the way for the deposit of tools, equipment, protective clothing and other items. Monitoring personnel and equipment should be appropriately placed along the path. A person travelling along the path should experience a decreasing level of contamination along the way. When showers or spray nozzles are used, adequate space must be provided to avoid contamination of other areas or persons.

PHOENIX REGIONAL
STANDARD OPERATING PROCEDURES

Hazardous Materials Decontamination

M.P. 204.01B

04/18

Page 3 of 5

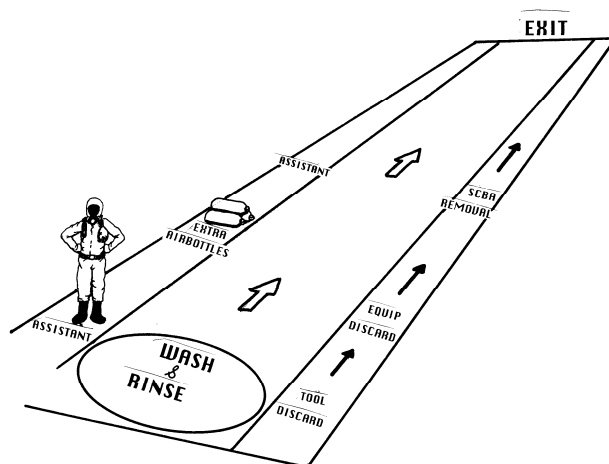

All contaminated items must remain within the perimeter of the Hazard Zone until decontaminated or safely packaged for removal. The Hazard Sector Officer or Decontamination Sector Officer will be responsible for supervising proper removal of these items. Personnel should be assigned to inspect persons and/or equipment before being released from the Decontamination Area. This inspection may be visual or may involve the use of monitoring instruments, when appropriate. It must be assumed that items or persons are contaminated unless their non-contamination can be confirmed.

Decontamination Area Precautions

During the decontamination process, all personnel working in the Decontamination Area must be adequately protected from contaminants. The Decontamination Sector Officer will identify and require the appropriate protective equipment. These individuals and their equipment may also require decontamination after use.

Any run-off or residue from decontamination procedures must be contained within the Hot Zone and retained for proper disposal. Contaminated run-off must not be allowed to spread or escape. Diking may be necessary and should be directed back to the Hot Zone.

Contaminated Patients

Patients in need of medical treatment should be removed from the source of contamination as quickly as possible but remain within the Hot Zone perimeter. These patients must not be allowed to contaminate further areas or persons. It may be necessary to bring treatment personnel (with adequate protective clothing) into the Hot Zone to deal with these patients unless they can be rapidly and effectively decontaminated. After decontamination, the patients and treatment personnel may leave the Hot Zone.

**PHOENIX REGIONAL
STANDARD OPERATING PROCEDURES**

Hazardous Materials Decontamination

M.P. 204.01B

04/18

Page 4 of 5

Transportation

Transporting of Level I patients should not be delayed for complete decontamination. Patients should be quickly treated for life threatening injuries simultaneously with decontamination efforts. Once treatment is completed and the patient is ready for transport, the patient should be covered and transported. The rescue should be brought to the Warm Zone perimeter for loading. When feasible, the rescue should be prepared by draping exposed surfaces with sheets or polyurethane covers. Patients should be wrapped or covered to lessen off-gassing of the products within the rescue. Rescue and treatment personnel may still have to wear protective garments and S.C.B.A. while enroute.

If it is necessary to transport contaminated patients to medical facilities, the receiving hospital must be notified in advance of the nature of the contamination, in order to make necessary preparations. The rescue used will be considered contaminated and must be decontaminated before being used to transport any non-contaminated persons. Helicopters will not be used for transporting any contaminated patients due to off-gassing effects on the pilot and flight crew.

Decontaminated Persons

When persons are decontaminated at a Decontamination Area, they may be released to leave the Hazard Zone. This includes Fire Department personnel, other emergency personnel, civilians and patients. The Decontamination Sector Officer will determine when it is appropriate to release custody of protective clothing, personal effects and equipment, after consulting appropriate medical personnel (i.e., health center physician or Poison Control Center physician). The Decontamination Sector Officer may release individuals who are substantially decontaminated and direct them to medical facilities for further evaluation or decontamination. Individuals may also be directed to shower, change clothes or take other secondary decontamination measures.

These personnel should complete an exposure form. The health center's exposure control officer will initiate contact and follow-up measures.

Protective Equipment and Personal Effects

When feasible, protective clothing and personal effects should be decontaminated and released from the Hot Zone with the individual. If the Decontamination Sector Officer determines this is not feasible, these items will be impounded in the Decontamination Area. Personal effects will be carefully guarded by Decontamination Sector personnel until a determination can be made regarding their final disposition.

PHOENIX REGIONAL
STANDARD OPERATING PROCEDURES

Hazardous Materials Decontamination

M.P. 204.01B

04/18

Page 5 of 5

Tools and Equipment

The Decontamination Sector Officer will determine when tools, equipment and apparatus may be released from the Hot Zone. No item shall be removed without approval. The Decontamination Sector Officer may impound equipment for later evaluation and have it packaged for storage or transportation. This impoundment will be accomplished following the consultation of medical and technical assistance.

**PHOENIX REGIONAL
STANDARD OPERATING PROCEDURES**

HAZARDOUS MATERIALS SPECIAL CONSIDERATIONS

M.P. 204.01C 04/98-R Page 1 of 2

GENERAL FACTORS TO CONSIDER

Due to the wide variety of situations Fire Department personnel may encounter in dealing with hazardous materials, these considerations will not attempt to provide specific guidelines on any one individual chemical or situation and are not listed in any priority.

It is important that the first arriving Fire Department company make every effort to determine what hazardous material(s) is involved, and the amount prior to taking action to stabilize the incident.

Call for additional resources EARLY. The actions taken by command in the first few minutes of an incident affects the outcome more than any other single factor. Hazardous Materials teams will be needed as well as a number of other fire companies to support site operations.

Make a slow, cautious approach to the incident. Entering the scene to make positive identification may be a considerable risk. The danger of explosion, leaking gas and poisoning may be great.

Furthermore, any "Knee-jerk" action taken prior to determining the product involved may place firefighters at considerable safety risk and may further compound the problem.

Transportation emergencies are often more difficult than those at fixed locations. The materials involved may be unknown, warning signs may not be visible or obscured by smoke and debris, the driver may be killed or missing. D.O.T. hazardous materials marking systems are inadequate because some hazardous materials in quantities up to 1,000 lbs., do not require a placard and there may be combinations of products involved with only a "dangerous" label showing. Sometimes only the most evident hazard is identified, while additional hazards are not labelled.

The following items should be considered at any Hazardous Materials incident. (Not all will be significant at any particular incident.)

1. Cooling Containers--Flame Impingement
 - a. Obtain adequate water supply, use large GPM hose streams or stang guns.
 - b. Apply heavy streams to the vapor space area above the tanks liquid line.
 - c. Use unmanned streams.
 - d. Use natural barriers to protect personnel.

2. Remove Uninvolved Materials
 - a. These actions should only be done after a complete site safety plan has been established by Command and H.I.R.T. Officers.
 - b. Move individual containers.
 - c. Move tank cars away from flame.
 - d. Cool containers before moving.

3. Stop the Leak
 - a. Use water spray to approach leak.
 - b. Close valves when safe to do so.
 - c. Do not apply water to chlorine containers - it will make the leak worse.

**PHOENIX REGIONAL
STANDARD OPERATING PROCEDURES**

HAZARDOUS MATERIALS SPECIAL CONSIDERATIONS

M.P. 204.01C 04/98-R Page 2 of 2

4. Apply Diluting Spray or Neutralizing Agent
 - a. Dilute water-soluble liquids, such as ammonia, chlorine, LPG (No water on CL2 tanks).
 - b. Use water with caution on some materials.

5. Construct Dams, Dikes or Channels
 - a. Direct running liquid away from exposures.
 - b. Control run off from corrosive or toxic materials.
 - c. Use sand or dirt.
 - d. Keep product out of sewer, storm systems, canals, or other waterways, etc.

6. Remove Ignition Sources
 - a. Start down wind.
 - b. Eliminate all sources of heat, spark, friction.
 - c. These actions may need to be accomplished in conjunction with the proper technical advice.

Dispatch has a Reference List of personnel and organizations which may be helpful during a Hazardous Materials Emergency.

These include:

1. Fire Department personnel with particular experience or knowledge.
2. Authorities in charge of landfills and dumps where Hazardous Materials may be disposed.
3. Commercial Chemical experts with experience in handling and disposing of most common chemicals.
4. Pesticide consultants and disposal teams with equipment to clean-up agricultural chemical spills.
5. Personnel from State and Federal Regulatory Agencies. These personnel should be contacted for incidents involving transportation of Hazardous Materials.
6. Railroad information numbers.
7. Tank Truck Companies with defueling capability (in case carrier involved in incident has none).
8. Radioactivity and Military Weapons emergency contacts.

**PHOENIX REGIONAL
STANDARD OPERATING PROCEDURES**

MERCURY RELEASES

M.P. 204.02

07/94-R

Page 1 of 4

PURPOSE

The purpose of this procedure is to establish and document guidelines to be used by the Phoenix Fire Department when a mercury release occurs at a commercial facility or in a residential setting, including the interior of apartments.

FACTS ABOUT MERCURY

There are three types of mercury; the two most common types are elemental and inorganic mercury.

Elemental Mercury (Hg^0): The most common sources of elemental mercury are blood pressure cuffs, oral and rectal thermometers, and in laboratories. Elemental mercury could also be found in the same processes where inorganic mercury may be used (see below).

Symptoms of initial toxic exposure to elemental mercury include fever, chills, dyspnea, and headache within several hours. Emergency care is supportive with transport to a hospital.

Inorganic Mercury (HG^+ , HG^{++}): The most common sources of inorganic mercury are scientific instruments, electrical equipment, felt making, and the manufacturing of caustic soda and disc batteries (watches).

Acute effects include, but are not limited to, burning mouth, sore throat, nausea and vomiting with severe gingivitis. Emergency care is supportive with transport to a hospital.

The third type of mercury and the least common is:

Organic Mercury (CH_3Hg): The most common sources of organic mercury are in mining, smelting, or refining operations.

Symptoms include, but are not limited to, hearing defects and loss of concentration.

MERCURY RELEASE AT COMMERCIAL FACILITY

Initial Action Required by Fire Department

1. Upon the arrival of Fire Department units, Command shall:
 - A. Contact the on-site responsible party;
 - B. Determine the amount of mercury released;
 - C. Determine the mercury source and, if possible, secure the source to prevent further mercury loss.
 - D. Determine the size of affected area;

**PHOENIX REGIONAL
STANDARD OPERATING PROCEDURES**

MERCURY RELEASES

M.P. 204.02

07/94-R

Page 2 of 4

**AT NO TIME SHALL THE FIRE DEPARTMENT
ATTEMPT TO CLEAN UP A MERCURY RELEASE!!!**

2. Command is also responsible to:

- A. **EVACUATE** the affected area;
- B. **ISOLATE** the affected area utilizing hazard line tape;
- C. **DENY ENTRY.**
- D. Request, through Dispatch, that the Fire Prevention Haz Mat specialist and the on-duty Special Operations personnel respond.

FIRE PERSONNEL

To reduce the possibility of contamination to Fire Department personnel, **FIRE DEPARTMENT MEMBERS:**

- A. **SHALL NOT ENTER THE REPORTED SPILL AREA, UNLESS FOR RESCUE OR TREATMENT.**
Shoes, carpet, etc., are easily contaminated. Not entering the reported spill area will reduce the potential spreading of the mercury.
- B. **SHALL NOT ATTEMPT TO CLEAN UP EVEN THE SMALLEST AMOUNT OF MERCURY RELEASED OR ANY OTHER HAZARDOUS MATERIALS RELEASE.**
- C. **SHALL NOT TAKE POSSESSION OF THE MERCURY.**

EXCEPTION:

- 1. When a resident brings mercury to the fire station, personnel may take possession of the mercury.
- 2. Fire Department members shall not take possession of mercury generated from a commercial business.

- D. **SHALL NOT TRANSPORT ANY QUANTITY OF MERCURY, OR ANY OTHER HAZARDOUS MATERIALS.**

FIRE PREVENTION AND SPECIAL OPERATIONS RESPONSIBILITIES

Fire Prevention may, depending upon each situation:

- 1. Respond to the incident location to document the requirement for a contractor with the appropriate equipment to clean up the spilled Mercury and to verify that the requirement is complied with.
- 2. Shall advise the responsible party of the contractors who have the appropriate equipment and shall remain on-scene until the contractor responds to the site.
- 3. Make or verify that all appropriate notifications are made.

On-duty Special Operations Personnel may, depending upon each situation:

- 1. Respond to the incident location to verify for the Incident Commander that all safety procedures are employed.

**PHOENIX REGIONAL
STANDARD OPERATING PROCEDURES**

MERCURY RELEASES

M.P. 204.02

07/94-R

Page 3 of 4

2. Assists the Incident Commander by verifying that the Fire Department's decontamination procedures are initiated and followed.
3. Make or verify that all appropriate notifications are made and notify the Incident Commander when completed.

RESPONSIBLE PARTY

The responsible party shall:

- A. When required, contact and employ a contractor who has the appropriate equipment to cleanup and transport the mercury for proper disposal. The Fire Department shall not make the contact for the responsible party because the Fire Department does not want to incur the costs associated with the response or cleanup by a contractor.
- B. Determine the names of persons who are known or suspected to be contaminated by mercury.
- C. Make any other contacts deemed appropriate for the particular situation.

KNOWN/SUSPECTED CONTAMINATED PERSONS

Until proven otherwise through appropriate meter readings, Command shall isolate persons who are suspected to be contaminated.

Based on the contractor's meter readings, the contractor may require:

- A. Decontamination; or
- B. Clean clothing be provided for the known/suspected contaminated persons.

KNOWN/SUSPECTED CONTAMINATED CLOTHING, SHOES, MISCELLANEOUS ITEMS

Based on test results, the contractor, not the Fire Department, shall determine when removal of contaminated items and confiscation of contaminated items may be necessary.

In the event clothing, shoes, jewelry or miscellaneous items, are removed from a person, place the items in a plastic bag, tie off, and place a name tag on the bag identifying the owner's name. **DO NOT USE BIOHAZARD BAGS** BECAUSE THE CONTRACTORS CANNOT ACCEPT IT; THERE ARE DIFFERENT FEDERALLY MANDATED DISPOSAL REQUIREMENTS THAT MUST BE COMPLIED WITH RELATING TO MERCURY AND BIOHAZARDOUS WASTE.

In addition, based on meter readings, decontamination may be required, at which time the Fire Department's decontamination procedures shall be initiated.

MERCURY RELEASE IN A RESIDENCE

The Arizona Department of Environmental Quality has determined that a mercury release that occurs in a residence, including the interior of apartments, is household hazardous waste. As a

**PHOENIX REGIONAL
STANDARD OPERATING PROCEDURES**

MERCURY RELEASES

M.P. 204.02

07/94-R

Page 4 of 4

result, the release is exempt from cleanup requirements. This does not, however, eliminate the need for response, evaluation of the hazard, and educating the homeowner/occupant.

Note: A mercury release in common public areas such as pool-side or exit corridors at apartment complexes, condominiums, etc. would require compliance with the commercial facility section of this management procedure.

FIRE DEPARTMENT OPERATIONS PERSONNEL

When responding to the report of a mercury release in a residence, including the interior of apartments, the Fire Department shall:

1. Have the Dispatch Center page Fire Prevention and Special Operations personnel requesting response.
2. Recommend to the homeowner/occupant that no one be allowed to enter the affected area until the hazard has been evaluated.

FIRE PREVENTION PERSONNEL

Fire Prevention personnel will explain to the homeowner/occupant of the hazards associated with the release of mercury and document on a 91-63 that it is the Fire Department's recommendation that a contractor with the appropriate metering equipment be employed to clean up and remove mercury contaminated items.

Fire Prevention will submit to the homeowner/occupant, the names and phone numbers of companies who have the proper mercury testing equipment.

Fire Prevention will also offer financial options that may be available to the homeowner/occupant such as homeowners insurance.

SPECIAL OPERATIONS PERSONNEL

Special Operations personnel will assist in the evaluation of the hazards associated with the release. In addition, Special Operations will verify that the Fire Department's decontamination procedures are initiated and followed, when deemed necessary.

**PHOENIX REGIONAL
STANDARD OPERATING PROCEDURES**

RADIOLOGICAL HAZARDS

M.P. 204.03

04/98-R

Page 1 of 4

This procedure is designed to provide basic operational guidelines for managing a radiological incident. This procedure is for peace-time radiological emergencies and does not specifically apply to nuclear warfare radiological contamination.

The Fire Department responsibilities during radiological emergencies include rescue, treatment, fire control/extinguishment, control of contamination spread and alerting responsible experts/agencies. Actual clean-up and overhaul operations will not normally be a Fire Department responsibility, although the Fire Department will be responsible for seeing that such operations are completed. Shippers and/or manufacturers of radiological materials will normally be responsible for clean-up operations using trained clean-up personnel and equipment.

DISPATCH

The Dispatch Center will dispatch either a 2-1 assignment or a 1st Alarm assignment, with the Hazardous Materials Team to any incident reported to involve radiological materials. The size of the assignment will be based on the location and type of situation reported.

Dispatch will advise responding units of the prevailing wind direction.

When a radiological incident is confirmed, Dispatch will notify:

1. D.P.S. Communications to dispatch personnel from the Arizona Radiation Regulatory Agency and D.P.S.--C.V.S.S. unit.
2. Phoenix Fire Department personnel with advanced radiological training--(list in Information File).
3. Maricopa County Civil Defense--on request from Command.

SITE OPERATIONS

At the scene, Command must consider both direct radiation exposure and contamination. If there is no life hazard, rescue situation or fire, there is no reason to risk exposure of Fire Department personnel. First arriving units should secure a perimeter, evaluate the situation and wait for the arrival of the Hazardous Materials Team.

If the immediate commitment of personnel is necessary, Limited Access Zone procedures shall be implemented to minimize the exposure and contain the spread of contamination.

The entry of personnel shall be limited to the absolute minimum number and time required for the urgent situation. These personnel will use full protective clothing and SCBA.

Any commitment of personnel to the Limited Access Zone shall include at least one survey instrument per team to monitor radiation hazard levels. Dosimeters shall be issued to all personnel operating at the scene.

**PHOENIX REGIONAL
STANDARD OPERATING PROCEDURES**

RADIOLOGICAL HAZARDS

M.P. 204.03

04/98-R

Page 2 of 4

Hazard Zone tape shall be stretched to define an area where readings of 2MR/hr are detectable. This must take into account potential downwind spread of contamination. Hazardous Materials Team personnel will determine readings and define the Limited Access Zone.

A Decontamination Area must be established within the perimeter of the Hot Zone, adjacent to the Lobby Control (entrance/exit) point. All personnel and equipment leaving the Hot Zone must be checked for radioactive contamination by qualified personnel. All persons or items must go to the Decontamination Area before leaving the Hot Zone. (See Decontamination.)

Patients requiring treatment, who cannot immediately be decontaminated, must be placed in an isolated Treatment Area, away from other patients and inside the Hot Zone perimeter.

TACTICAL CONSIDERATIONS

Incidents With Fire:

1. Initiate normal tactical firefighting operations.
2. Always approach from upwind.
3. Do not ventilate.
4. Minimize the use of water.
5. Control water runoff-impound for disposal.
6. Minimize exposure of personnel.
7. Use full protective clothing with SCBA.

Rescue/EMS Incidents:

1. Remove patients quickly.
2. Treat patients for medical problems/injuries.
3. Alert hospitals to prepare for contaminated patients.
4. Use full protective clothing and SCBA.
5. Decontaminate vehicles used to Transport.

NUCLEAR WEAPONS

The radiological hazard of nuclear weapons in transit is similar to other radioactive materials and can be handled with similar tactics.

These weapons however, contain considerable amounts of high explosives which may be shock sensitive and can detonate very easily. They are especially dangerous when the weapon has broken up and the high explosive is scattered about. If a nuclear weapon involves fire, evacuate the area of 2,000 feet, in all directions, immediately. All down wind areas must be checked for contamination.

**PHOENIX REGIONAL
STANDARD OPERATING PROCEDURES**

RADIOLOGICAL HAZARDS

M.P. 204.03

04/98-R

Page 3 of 4

TREATMENT OF CONTAMINATED PATIENTS

Do not delay field treatment of injuries. Radiological contamination, itself, is not a medical emergency. Treatment of contaminated patients should proceed with the following precautions:

- All contaminated patients should be placed in one Treatment Area--separate from noncontaminated patients--within the Hot Zone perimeter, but beyond the 2 MR/hr exposure distance.
- All treatment personnel should use SCBA or dust-filtering type masks, long sleeve shirts or coats, gloves and nomex hoods.
- A mask or other airway filtering means should be used on the patient to limit Inhalation/ingestion of airborne contamination.
- Bandage all open wounds as quickly as possible to prevent wound contamination.
- Carefully peeling or cutting of outer clothing from the patient's body will remove most of the contamination.
- Removed clothing, watches, wallets, etc., must be placed in plastic bags or other appropriate containers, sealed and properly identified.
- A clean plastic bag or other clothing should be placed over the patient's scalp hair to minimize the spread of contamination. Do not cover face.
- Much of the contamination on a patient's skin can be removed by wiping with a moist cloth or tape (put in plastic bag afterwards).
- Hot spots of contamination on the patient's body that cannot be removed by wiping, etc., should be marked with ink outline or tape.
- Before transporting, all contaminated patients must be wrapped in blankets or sheets to completely cover them in order to limit the spread of contamination. Only the face should be left exposed.
- Hospitals and rescues must be alerted early and before patient transportation is initiated so they can prepare to receive radioactive contaminated patients.
- All contaminated patients should be sent to a single hospital or to as few as possible. Once contaminated, these hospitals could be out-of-service for some time.
- Where there are large numbers of contaminated patients, place as many patients as possible in each rescue to minimize contamination spread to other rescues.
- Reuse of contaminated rescues for contaminated patient transportation should be considered. If all available rescues become contaminated, these vehicles can be out-of-service for long periods of time until they can be decontaminated.
- Before treatment personnel can be released from the scene, they must be checked for contamination and decontaminated. All equipment used in patient treatment must also be checked and decontaminated. This evaluation will be conducted in the Decontamination Area.

PHOENIX REGIONAL
STANDARD OPERATING PROCEDURES

RADIOLOGICAL HAZARDS

M.P. 204.03

04/98-R

Page 4 of 4

FIRELINE TAPE

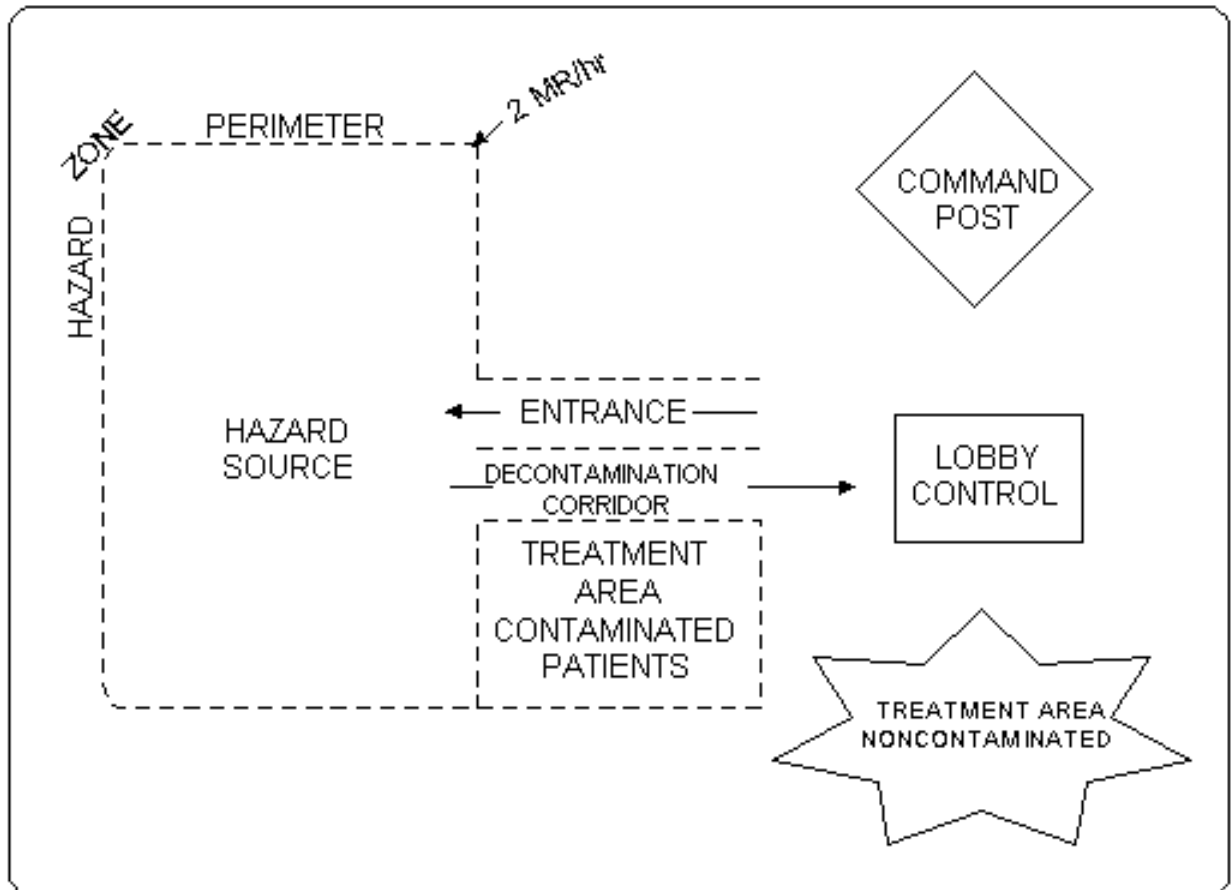

**PHOENIX REGIONAL
STANDARD OPERATING PROCEDURES**

RADIOLOGICAL DECONTAMINATION

M.P. 204.03A 04/98-R Page 1 of 2

Personnel may be contaminated with alpha or beta radioactive emitting material at any radiological incident. In order to prevent any health risk to personnel and to control the spread of the contamination, the following steps should be taken:

- All personnel (both fire and civilian) that were inside the Hot Zone must not be released from the zone until they have been surveyed with radiation detection instruments and decontaminated if necessary.
- Contaminated personnel leaving the Hot Zone must pass through the Decontamination Area. (See sketch)
- All personnel reporting to the Decontamination Area will remain fully dressed in protective gear, including gloves and SCBA (facepiece in place).
- No smoking, drinking or food consumption will be permitted until all exposed personnel are determined to be free from contamination.
- All contaminated clothing and equipment must be removed and held in the Decontamination Area.

Plastic bags or plastic trash containers must be utilized to contain contaminated clothing and equipment. (City plastic trash containers are excellent for this purpose and may be confiscated from any nearby residential area or obtained through the City Sanitation Department.)

Removal of Contaminated Equipment and Clothing

All radioactively contaminated equipment and clothing must be placed in plastic containers at one of three collection points (see diagram).

1. At the first survey point all personnel will be checked in with monitoring instruments. If not contaminated, personnel may leave the Warm Zone via Lobby Control.
2. Contaminated personnel will place coat, boots and bunker pants in the first container, continuing to maintain SCBA facepiece in place. All items must be gently handled to avoid spreading dust (radioactive particles) and using gloves at all times. Actions should avoid contaminating inner clothing, skin and particularly hands. SCBA harness and cylinder must be carried to second container.
3. After the second container, personnel will again be checked and, if free of contamination, may be released from the Hot Zone. If still contaminated, personnel must proceed to the third container.
4. At the third collection point, all outer clothing will be removed and personnel will be checked again with monitoring instruments. If still contaminated, personnel must shower at the site, using a portable shower and soap. Showering must pay particular attention to body areas which may collect contaminants (armpits, hair, fingernails, etc.) and avoid runoff into eyes or ears.

PHOENIX REGIONAL
STANDARD OPERATING PROCEDURES

RADIOLOGICAL DECONTAMINATION

M.P. 204.03A 04/98-R Page 2 of 2

Following showers, personnel will again be surveyed for contamination, before being issued with clean coveralls.

NOTE: Shower runoff water must be impounded and collected. All personnel released from the Hot Zone shall be directed to shower and shampoo and put on clean clothes as soon as possible after the incident. Medical evaluation will be arranged for all exposed personnel as quickly as feasible.

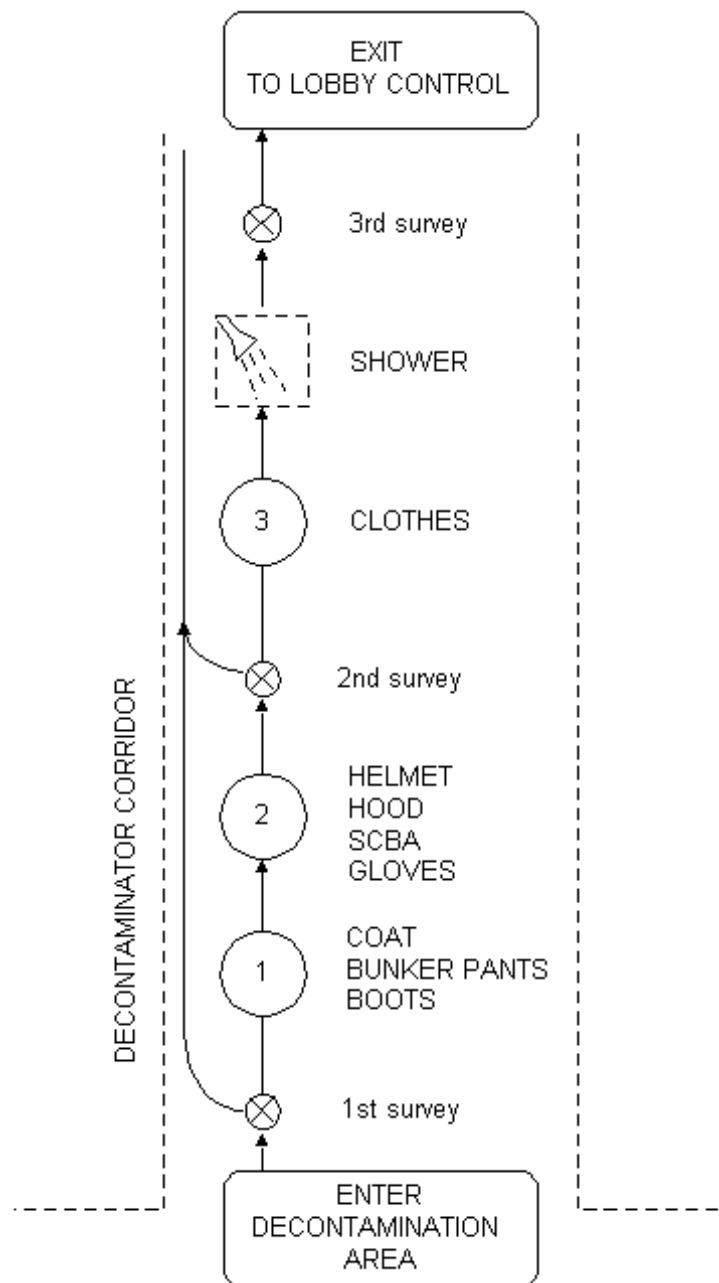

PHOENIX REGIONAL
STANDARD OPERATING PROCEDURES

FLAMMABLE LIQUID INCIDENTS

M.P. 204.04

03/09-R

Page 1 of 3

PURPOSE

The purpose of this M.P. is to describe standard operating procedures for response to incidents involving flammable liquids. The four primary areas of concern are **extinguishment of flammable liquid fires, spills without fire, disposal and firefighter safety.**

Flammable liquids present particular problems for fire protection, health, safety, and environmental protection. The frequency of encounters with flammable liquids makes them a particular concern for the fire department.

The main operational problems with flammable liquids are fire extinguishment, ignition prevention, and disposal of spills. All three of these may be involved in the same incident.

EXTINGUISHMENT

The preferred agent for flammable liquid fire fighting is AFFF/Class B Foam (Aqueous Film Forming Foam). Fire apparatus that carry AFFF/Class B Foam are designated with a CBF (Class B Foam) in CAD and are available on request through Phoenix Regional Dispatch if not already on the incident.

Attack on any flammable liquid fire should be made with Class B Foam when available. When the fuel is ethanol, or ethanol based (E-10, E-85 or E-95), fire attack should utilize an Alcohol Resistant Aqueous Film Forming Foam (AR-AFFF) due to the high alcohol content of the fuel. The use of alcohol resistant class B foam is also required when dealing with any polar (water soluble) flammable liquid. The class B foam should be applied at the percentages specified by the foam concentrate manufacturer.

The PFD currently uses AFFF/AR class B foam concentrate on all class B foam equipped apparatus except for Sky Harbor Airport apparatus. The class B concentrate used by the Airport is AFFF and does not have the alcohol resistive characteristics needed for polar flammable liquids.

The extinguishing action of Class B Foam is based on its ability to rapidly cover the flammable liquid surface with a film. This film prevents the escape of flammable vapors, but may have difficulty sealing against hot metal surfaces. The application of Class B Foam should be gentle to avoid breaking the seal and agitating the liquid below.

Dry Class A compressed air foam (CAFS @1%) can be used to extinguish a small flammable liquid fire i.e. a car with leaking fuel tank. It must be understood that while CAFS can be used as an extinguishing agent, Class A foam has **NO ability to suppress vapors and reignition is an extreme possibility**. If extinguishment with CAFS is being performed during a rescue, continuous application of new foam is required as long as crews are in the hazard zone.

Fires involving a large area of burning flammable liquids may exceed the ability of one hand line to extinguish. It may be more important for Command to wait until there is enough Class B foam on site to initiate a coordinated attack. One 95 GPM class B foam line is needed for every 600 square feet of spill area. The initial fire attack will require 187 gallons of concentrate when used at 3% and 374 gallons of concentrate when used at 6%. Water master streams should be used to cool and protect exposures during the interim.

PHOENIX REGIONAL
STANDARD OPERATING PROCEDURES

FLAMMABLE LIQUID INCIDENTS

M.P. 204.04

03/09-R

Page 2 of 3

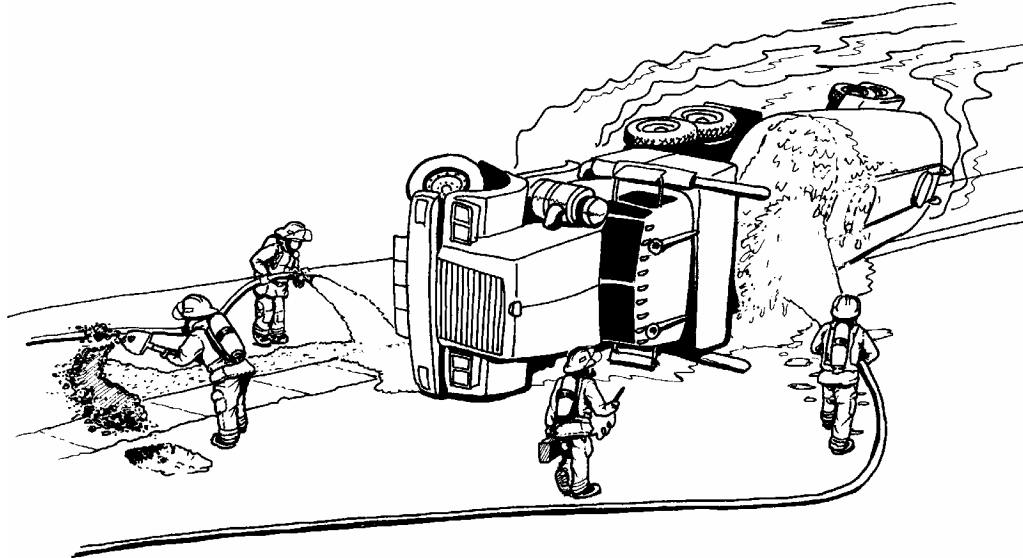

SPILLS

Flammable liquid spills include spills without fire and any remaining fuel after a fire has been extinguished. In both of these cases, the liquid must be protected to prevent ignition until it can be picked up or removed.

All personnel working around spills must wear full protective clothing to afford protection in case of possible ignition. SCBA must be used in vapor areas. Vapor areas can only be found through the use of combustible gas indicators carried by all Special Operations Response Team units. A Hazardous Materials Response Team company should be dispatched to test the atmosphere if there is a potential question about the flammability.

1. Do not permit the flammable liquid to run-off into storm drains, sewers, or drainage systems. Dam the run-off and cover drains and sewers pending disposal. Consider the use of plastic dike, charged hose lines, black plastic, or dirt to prevent the further spread of spilled material if it can be done safely.
2. Control ignition sources in the area of the spill. Extinguish pilot lights, flares, open flames, etc. Prohibit smoking. Position vehicles to prevent contact of vapor with running engines or exhaust. Disconnect electrical power from a remote location to prevent arc-caused ignition.
3. Cover spills with class B foam to seal vapors. The application will need to be repeated regularly, as the seal will break down in 10 to 15 minutes. One 95 GPM class B foam line is needed for every 600 square feet of spill area. The initial application will require 43 gallons of concentrate when used at 3% and 86 gallons of concentrate when used at 6%. Haz-Mat crews will need to check for escaping vapors with a combustible gas indicator to judge when the seal is breaking down.

**PHOENIX REGIONAL
STANDARD OPERATING PROCEDURES**

FLAMMABLE LIQUID INCIDENTS

M.P. 204.04

03/09-R

Page 3 of 3

DISPOSAL

1. Large quantity spills should be disposed of by a specialized hazardous materials clean-up contractor per C99. This may require a fuel transfer pump or vacuum truck and personnel familiar with fuel transfer precautions.
2. Smaller spills, which cannot be picked up with a tanker, must be absorbed if it has not already evaporated.
3. Special Operations carries small amounts of absorbent but the most often used and preferred method is using sand delivered by the Streets Department. Larger spills will require a street sweeper or a licensed clean-up contractor to remove the sand depending on the Jurisdiction Having Authority (JHA).
4. The Spiller must be given the opportunity to clean up his spill if he can do so, while adhering to appropriate regulations. Otherwise, a specialized hazardous materials cleanup contractor will be called.
5. Large quantity spills require the response of a unit from the Hazardous Materials Response Team in addition to Car 957.

SAFETY

As early as possible, a hazard zone should be established and marked through the use of fire line tape. This zone should include the spilled material in the area down wind of the spill of sufficient distance to account for reasonable vapor travel:

All personnel working in the hazard zone must wear full protective clothing including SCBA with face piece on.

Unless absolutely necessary, personnel shall not work in a spill area. When this is necessary to perform a rescue or to control a leak, the spill must be covered with foam and all possible precautions against ignition must be taken. The area shall be monitored with a combustible gas indicator.

FIRE CODE VIOLATIONS

Most flammable liquid incidents involve Fire Code violations. Have the Dispatch Center dispatch Car 99 to investigate this aspect of the incident and take appropriate action.

**PHOENIX REGIONAL
STANDARD OPERATING PROCEDURES**

NATURAL GAS EMERGENCIES

M.P. 204.05

05/21

Page 1 of 6

The Phoenix Regional Automatic Aid System responds to thousands of incidents each year that involve natural gas. We must remain cognizant of the hazards associated with gas emergencies, the need to meter, control gas leaks and evacuate those threatened. Most important of all, we must remain vigilant and prevent complacency.

Natural gas (Methane) is extremely flammable, lighter than air, is colorless and odorless. Due to these characteristics, Mercaptan is added to natural gas to help indicate its presence and will result in an odor like rotten eggs. The flammable range of natural gas is 4 percent Lower Explosive Limit (LEL) to 15 percent Upper Explosive Limit (UEL) by volume. Although natural gas is non-toxic, it can displace oxygen, which can cause asphyxiation in certain settings. The presence of natural gas in its flammable range can be evaluated with the use of a Combustible Gas Indicator. This is done by the Hazardous Materials Response Teams (HMRT) and/or the appropriate utility company.

Fires involving natural gas should be controlled by stopping the flow of gas. In most cases, burning natural gas should not be extinguished as this would change the situation from a visible to an invisible hazard with an explosive potential. Because natural gas is lighter than air, if confined it has the potential for a catastrophic explosion. Natural gas leaks above ground are much easier to manage than below ground leaks.

PROCEDURE

Fire Department units may encounter natural gas in a variety of situations and incident types, each presenting a unique set of hazards. These incidents can range from a simple check odor to potential major incidents involving natural gas explosions. The following guidelines present an approach which will be applicable in many situations, but do not replace good judgment and experience when dealing with any incident. Incidents involving natural gas should be managed using the risk management profile and strategic decision-making model (M.P. 201.01C).

PERSONNEL SAFETY

Per M.P. 202.05B, all personnel working in the vicinity of a potential explosion or fire area, including gas leaks and fuel spills, shall wear full protective clothing with SCBA, face piece donned and breathing air. A Hot Zone shall be established and defined by "fire line" tape. Personnel working in the hot zone, (e.g. attempting to secure a gas leak), shall be protected by a hose line. The number of exposed personnel will be kept to a minimum while still assuring crew accountability and a minimum of two personnel.

**PHOENIX REGIONAL
STANDARD OPERATING PROCEDURES**

NATURAL GAS EMERGENCIES

M.P. 204.05

05/21

Page 2 of 6

ACTIONS OF THE FIRST ARRIVING FIRE DEPARTMENT UNIT (NON HAZ-MAT)

- Perform a scene size up and establish Command. Consciously avoid committing apparatus or personnel to a dangerous situation or a situation that could become dangerous due to gas migration.
- Attempt to locate the homeowner or other RP and begin to gather information as to the hazard, potential victims, etc.
- Evacuate the area, working towards an "All Clear" of the immediate area and surrounding structures if necessary.
- Isolate the area/scene – Establishment of a "Hot Zone" is critical.
- Deny entry.
- If incident is determined to be a natural gas leak, ensure that personnel safety practices are in place when working in the Hot Zone including the wearing of the appropriate PPE with SCBA, face piece donned and breathing air. Establish a water supply and ensure that a charged hose line is in place. This line must be attended when Haz-Mat crews or gas company personnel are securing the leak.

ACTIONS OF THE FIRST ARRIVING HAZ-MAT UNIT

- First arriving Hazardous Materials Response Team should be assigned Hazard Sector
- Ensure that firefighter safety practices are in place when working in the Hot Zone, including wearing the appropriate PPE with SCBA face piece donned and breathing air.
- Ensure that a charged hose line is in place and manned when Haz-Mat crews or gas company personnel are securing the leak.
- Contact initial crews, the RP, and gas company personnel (if on scene) to gather information about the hazard.
- Reevaluate the initial Hot Zone using metering devices, including Combustible Gas Indicators (CGI), and adjust the boundaries as necessary based upon the situation and meter readings.
- Gather necessary tools and equipment needed to mitigate the hazard.
- In situations where gas company personnel are needed to assist with the mitigation efforts, ensure that they are dressed in the appropriate PPE including SCBA's.

INCIDENTS INVOLVING A REPORTED GAS LEAK - NO FIRE OR EXPLOSION

Calls for "odor of gas," "gas leak," "broken gas line" and similar situations may range from minor to major incidents. Each of these scenarios should be approached as

**PHOENIX REGIONAL
STANDARD OPERATING PROCEDURES**

NATURAL GAS EMERGENCIES

M.P. 204.05

05/21

Page 3 of 6

potentially dangerous situations. Although there is not a visible hazard, fire or explosion, the situation can change instantly. Uncontrolled flammable gas leaks should never be approached with a “routine” mindset. Safe and effective operations necessitate appropriate size up, approach, establishing and controlling the perimeter, and hazard mitigation.

In all cases, Fire Department units shall take appropriate actions, using the Risk Management Profile (M.P.201.01c) to provide for life safety and property conservation.

If gas company personnel are on the scene of an incident prior to arrival of fire crews, the best practice is for the first arriving Fire Department unit to make contact with the on-scene gas company and determine needs. Gas company personnel shall be responsible for locating and eliminating the source of the leak. Gas company personnel and/or the Hazardous Materials Response Team shall obtain a sufficient number of gas concentration readings, using various tools, including combustible gas indicators for Command to evaluate the hazard and take appropriate action.

The Hazardous Materials Plan (M.P. 204.01) should be used as a basic guide for these incidents. A minimum number of personnel should be allowed to enter the area to size-up the situation while any additional unit’s stage outside the hazard zone, preferably up wind of the incident.

In addition to evacuating, isolating, and denying entry, non-tech fire crews can attempt to locate the source of the gas and any shutoff devices available.

- If the location of the incident is a **SINGLE-FAMILY DWELLING** and the source of the leak can be identified it would be appropriate to secure the gas to the appliance or meter if needed. Wait for the arrival of Haz-Mat crews if a source of the leak cannot be located.

- If the location of the incident is a **COMMERCIAL OCCUPANCY OR OTHER LARGE OCCUPANCY** (e.g. large warehouses, hospitals, etc.) refrain from attempting to secure the natural gas unless there is an immediate life hazard. Securing the gas main is often difficult to accomplish due to the size and complexity of the occupancy. Best practices should include evacuation, isolation, and the denial of entry until Haz-Mat crews and/or gas company personnel arrive on scene.

**PHOENIX REGIONAL
STANDARD OPERATING PROCEDURES**

NATURAL GAS EMERGENCIES

M.P. 204.05

05/21

Page 4 of 6

- If the location of the incident involves an **APARTMENT COMPLEX**, the best practice is to try and determine the source of the leak. If you can isolate the leak at an appliance, secure the source, (e.g. incoming gas line at the dryer or stove). If the leak is at a bank of meters, best practices should include evacuation, isolation, and the denial of entry until Haz-Mat crews arrive on scene.

Gas leak situations within a building where the source of the leak is unknown or uncontrolled, the gas supply should be shut off at the meter. This should only be done in coordination with on scene HazMat units, C957 or Gas Company representative.

If there is any indication of gas accumulating within a building, evacuate occupants from the structure, isolate the area and deny re-entry and await the arrival of HazMat units. Attempting to secure ignition sources, e.g. turning off power, can lead to an explosion. If there is imminent life safety concern, use the appropriate actions necessary following the Risk Management Plan (M.P.201.01c).

First arriving Hazardous Materials Response Team (HMRT) should be assigned Hazard Sector and should initiate metering the area to re-evaluate the established Hot Zone boundaries. Hazard Sector will assess their ability to mitigate the leak. At this time Hazard sector should work with other utility companies to secure ignition sources including electricity. Securing electricity may not take place onsite but at a remote location. Hazard sector should consider ventilating the structure using natural ventilation and/or intrinsically safe equipment if available. Battery operated equipment does not necessarily mean intrinsically safe.

Hazard Sector should work with the gas company to obtain sufficient number of gas concentration readings in the event the leak has not been identified. If gas company personnel are actively securing the leak in the HOT ZONE, fire department crews shall provide stand-by protection with a charged 1 ¾ hand line and minimum of two firefighters in appropriate PPE with SCBA, face piece donned and breathing air.

Operating personnel should remain pessimistic in their approach to reported gas leaks and should utilize HMRT crews and the utility company resources to rule out any potential hazards.

**PHOENIX REGIONAL
STANDARD OPERATING PROCEDURES**

NATURAL GAS EMERGENCIES

M.P. 204.05

05/21

Page 5 of 6

INCIDENTS AT WHICH AN EXPLOSION OR FIRE HAS OCCURRED

Units arriving at the scene of a structural explosion must consider natural gas as a possible cause and recognize the potential signs including a debris field, and/or structural damage.

Explosions have occurred in structures which were not served by natural gas. Underground leaks may migrate considerable distances before entering a structure through the foundation, around pipes, or through void spaces. When natural gas migrates in this manner, Mercaptan may be scrubbed as the gas travels underground leaving the gas truly odorless. In these circumstances, the cause of the explosion may be difficult to determine.

First arriving crew should perform the following:

1. Effective size up, recognize the signs of a gas explosion.
2. Determine the presence of victims, their condition, and triage.
3. Identify immediate hazards (e.g., collapse, leaking gas, fire, etc.).
4. Develop an incident action plan, consideration given to the need for rescue of trapped occupants, structural collapse and/or integrity, treatment, fire control, etc. Also, address accomplishment of an "All Clear" on involved structure and surrounding structures (evacuation).

Until it can be determined that the area is safe from the danger of further explosions, evacuate all civilians and keep the number of Fire Department and/or other emergency personnel (e.g., gas company) in the area to the minimum number necessary to stabilize the situation. Take a pessimistic point of view.

The Incident Commander must establish a Hazard Sector as soon as possible. Hazard Sector should establish Hot, Warm, Cold, and No-Entry Zones as necessary. The Hot Zone should include any areas where gas detection equipment identifies reading of 10 % of the LEL (0.4% gas) or greater. If a gas concentration is encountered inside, adjacent to, or underneath any building, secure all possible sources of ignition in the affected area. HazMat crews will, in coordination with utility company personnel, secure electricity from outside the affected area to avoid arcing if necessary. Before securing any potential ignition source, evaluation and metering should take place. Hazard Sector should consider ventilating the structure using natural ventilation and/or intrinsically safe equipment if available. Battery operated equipment does not necessarily mean intrinsically safe.

**PHOENIX REGIONAL
STANDARD OPERATING PROCEDURES**

NATURAL GAS EMERGENCIES

M.P. 204.05

05/21

Page 6 of 6

Use combustible gas indicators to systematically check all suspected areas. Start outside of the area of the explosion and move into the area until readings indicate detectable concentration. Both gas company personnel and the HMRT will establish warm and hot zones.

The use of ground probes is essential to evaluate potential underground leaks. However, in extraordinary circumstances, such as migration of gas in a sewer system, ground probes may not be sufficient and other detection devices may be required. When gas company personnel are on the scene, ground probe readings and locations must be coordinated.

Command shall provide for effective interaction between gas company personnel and the Fire Department. Gas company personnel are responsible for locating and eliminating leaks in the gas system. As industry specialists, they can provide Command with valuable assistance in the effective handling of these incidents. In all cases, C957 or Haz Mat Company Officer, will be required to supervise during on-site operations.

Command must ensure the safety and stability of all involved structures. If further collapse is possible and a life safety hazard exists, Technical Rescue Teams and other specialty resources should be called to provide for structural stabilization. Additional appropriate resources should be requested as needed. (e.g., C99 should be dispatched and structural engineers requested if necessary).

**PHOENIX REGIONAL
STANDARD OPERATING PROCEDURES**

MONITORING ATMOSPHERIC CONDITIONS

M.P. 204.06

10/97-R

Page 1 of 1

This procedure establishes policy and procedures for all personnel involved in making atmospheric measurements using monitoring instruments.

PURPOSE

The purpose of this policy and procedure is to establish the highest level of accuracy for atmospheric monitoring instruments. This will allow the user and field personnel to operate in high levels of instrument accuracy. This ongoing methodology for spanning and calibrating of atmospheric monitoring instruments should ensure the highest level of safety for all personnel.

RESPONSIBILITIES

It shall be the responsibility of all members using, or supervising the use of, atmospheric monitoring instruments to span and/or calibrate these devices in the following manner.

SPANNING

Spanning and/or calibration shall be done on each instrument (except RMD* instruments) prior to making entry into the following atmospheres:

- contaminated atmospheres
- atmospheres which may suddenly become contaminated
- atmospheres where there is suspected oxygen deficiency
- atmospheres which are suspected of being contaminated or oxygen deficient

or at any other time it may be necessary to render an instrument in a ready state of condition. This instrument will be spanned on the proper calibration gas, hose and regulator to ensure the instrument of choice is in proper operating condition. At any time the instrument does not span or calibrate correctly, and you cannot resolve the problem, you will not use the instrument. You will then bring the instrument to the Special Operations Section and change out for another instrument.

TRACKING

To keep track of all the spanning and calibration being performed on all atmospheric monitoring instruments, a Control Log has been developed. It is called the "Meter Calibration and Span Control Log." This Control Log will be used to document weekly calibration and spanning being done prior to the use of the instruments. The form will be completed on a monthly basis and forwarded to the Special Operations Sector.

Calibration of instruments shall be on a weekly basis to ensure proper maintenance is being performed on all instruments, according to manufacturer's recommendations. Calibration of all instruments (except RMD* instruments) shall be performed at the Special Operations Section on a monthly basis and logged into master control file for each instrument. This master control file shall act as a legal history of that instrument's performance.

*RMD--Radiological Monitoring Devices

**PHOENIX REGIONAL
STANDARD OPERATING PROCEDURES**

CLANDESTINE DRUG LABORATORIES

M.P. 204.07 06/97-R Page 1 of 3

SCOPE

The number of clandestine drug laboratories has increased dramatically in recent years. The number of seizures, "busts," or "raids," made by law enforcement agencies has also increased. Clandestine drug laboratory investigations, seizures, and arrests of suspects are all police department or law enforcement agency matters. However, local law enforcement agencies are calling upon fire department hazardous incident response teams for assistance during raids and for advice on safety matters.

POLICY

The Phoenix Fire Department will provide limited support for police departments and other agencies, when requested, at sites of clandestine drug laboratories. Support may consist of, but is not limited to: providing research and information on chemicals that are suspected or are known to be in the laboratory, remote exterior air monitoring, and decontamination of police entry personnel.

HAZARDS

Substitution of proper equipment with unsafe items is prevalent in low budget clandestine laboratory operations. For example, pressure cookers have been substituted for three neck flasks in the initial cooking stage of methamphetamine. Without ventilation, this type of operation can easily generate toxic levels of phosphine gas.

Booby traps have been left in place and armed when a lab is abandoned. Opening or moving doors, windows, refrigerator doors, chemical containers, or furniture may be a triggering mechanism for an explosive device or chemical reaction that is lethal. Trip wires made from monofilament fishing line may be strung across doorways, hallways, or across rooms to activate different types of devices. It is imperative that **nothing** is moved, shut off, turned on, or touched, at a laboratory, whether it is operational or abandoned. Electric switches, vacuum pumps, glassware, chemical containers, or anything that is plugged into a wall outlet should not be touched. Water sources, especially to reflux or condensing towers, should not be shut off. Shutting off the water supply to a cooking process can result in an explosion.

INDICATORS

Personnel should be aware of the indications of potential clandestine drug laboratories when responding to EMS, fire, check odor, or an other service request. Common indicators are:

- Unusual odors like ether, acetic, solvents, and odors of urea.
- Glassware that is normally associated with school or industrial laboratories, such as flasks, beakers, flasks with vacuum ports, glass cooling towers, and funnels.
- Heating elements, hot plates, or heating mantles.
- Vacuum pumps, plastic or rubber tubing.
- Marked and unmarked chemical containers of various sizes.

**PHOENIX REGIONAL
STANDARD OPERATING PROCEDURES**

CLANDESTINE DRUG LABORATORIES

M.P. 204.07 06/97-R Page 2 of 3

SUSPECTED DRUG LABORATORY OPERATION - NOTIFICATION PROCESS

Personnel that encounter a suspected laboratory should withdraw to a safe location as soon as it is possible, using discretion on actions and radio conversation. The on-duty Battalion Chief, the Police Department, and the Special Operations duty person should be notified of the situation. If a situation warrants additional immediate action (e.g. evacuation of surrounding areas, several victims, a chemical release or spill), the Dispatch Center should be requested to send the appropriate level of a hazardous materials assignment. Command should also request the response of the Department of Environmental Quality (DEQ) Emergency Response Division.

NOTIFICATION FOR USE OF H.I.R.T. UNITS

Any agency requesting the Hazardous Incident Response Team for assistance during seizure of a clandestine drug laboratory shall contact the Duty Deputy or Car 94 for scheduling of the Hazardous Incident Response Team. The agency that is requesting the assistance shall provide information on location, time, staging area, and the type of assistance that is needed. A pre-incident meeting shall be scheduled between the agency and Car 94 to address the concerns noted above. Security of information will be strictly adhered to.

The Duty Deputy, District Commander, and Battalion Chief of the affected district/battalion will be notified at an appropriate time, but in all cases, at the time entry is made. Such notification will be initiated by Car 94.

TACTICAL CONSIDERATIONS

The recognition of the presence of a clandestine drug laboratory that is involved in a fire may not occur until after fire control has been achieved. The initial indications of the presence of a laboratory may be subtle or very apparent. Depending on the products involved, a fire in a lab can spread faster and burn with more intensity than what might normally be expected. The color of the flames may appear to be an unusually bright or dark orange, or the flames may be of several different colors. An unusual color of smoke or odor may also be present.

A laboratory that is involved in a fire situation should be viewed pessimistically by Command. Command should request the Dispatch Center to send balance of the appropriate level of a hazardous materials assignment. A defensive mode may be appropriate for personnel safety. Standard protective clothing and SCBA use may not afford complete protection. An acceptable alternative is to protect any exposures and allow the fire to burn, providing the products of combustion being generated are not complicating the problem further. Run-off may also create a problem and diking may be necessary.

**PHOENIX REGIONAL
STANDARD OPERATING PROCEDURES**

CLANDESTINE DRUG LABORATORIES

M.P. 204.07

06/97-R

Page 3 of 3

HEALTH AND SAFETY

Personnel showing any signs or symptoms of a chemical exposure during or after any incident involving a laboratory or a suspected laboratory should be treated and transported to Poison Control, providing that the exposure is not a critical life threatening emergency. Critical life threatening injuries require transport to the closest hospital. All potentially exposed personnel and equipment must be decontaminated. All potentially exposed personnel should complete a Hazardous Materials Exposure Report Form (91-38D). Exposed equipment, especially protective clothing, may have to be properly disposed of. Notification of Health and Fitness Deputy, Exposure Control Officer, and Safety Officer shall be made.

ENTRY

Phoenix Fire Department personnel **will not** participate in a law enforcement agency entry operation into a suspected and unsecured clandestine drug laboratory. Security shall mean that the Police Department Bomb Squad and S.A.U. teams have surveyed the area and all suspects are in custody, and confirmation that the building has been searched and no explosive devices were found. Phoenix Fire Department personnel may make an entry into a secured drug laboratory if an emergency situation involving hazardous materials develops and if the safety of Phoenix Fire Department personnel is not jeopardized.

Prior to taking any action at a suspected clandestine drug laboratory, the Phoenix Fire Department will request the response of a representative of the Department of Environmental Quality Emergency Response Division. If a representative from the Department of Environmental Quality is unable to respond directly to the location of the incident, every effort will be made to contact a representative by telephone to inform them of the situation. This shall be accomplished by the Special Operations duty person.

ADDITIONAL FIRE DEPARTMENT RESOURCE

Additional resource requirements needed at the site will be determined by the Special Operations Duty Officer or Battalion Chief. A multi-company response will cause the activation of the incident command system.

DISPOSAL

Proper disposal of the hazardous material(s) in a clandestine laboratory is the responsibility of the law enforcement agency that is making the seizure. The law enforcement agency on-scene must arrange clean-up with the proper contractor.

**PHOENIX REGIONAL
STANDARD OPERATING PROCEDURES**

CONFINED SPACE RESCUE

M.P. 204.08

07/11-R

PAGE 1 of 8

SCOPE

This procedure establishes a standard structure and guideline for all fire department personnel operating at incidents involving confined space rescues. The procedure outlines responsibilities for first-responders, TRT units, Command Officers, and other fire department personnel responding to such incidents. All other Phoenix Fire Department procedures shall apply to confined space rescue operations where applicable.

PURPOSE

The purpose of this procedure is to establish guidelines for the response of fire department personnel and equipment to confined space rescue incidents. Because confined space rescue operations present a significant danger to fire department personnel, the safe and effective management of these operations require special considerations. This procedure identifies some of the critical issues which must be included in managing these incidents.

TACTICAL CONSIDERATIONS

OSHA Regulations Standard 29 CFR 1910.146 Permit-Required Confined Spaces regulates entry into confined spaces for general industry and the rescue service and shall be considered the basis for confined space rescue operations. For the purpose of emergency response, a confined space is defined as:

- A space large enough for personnel to physically enter.
- A space not designed for continuous employee occupancy.
- An area with limited entry and egress.

Confined spaces include caverns, tunnels, pipes, tanks, mine shafts, utility vaults, and any other location where ventilation and access are restricted by the configuration of the space. These factors may also apply to basements and attics. Confined space incidents may involve injured persons or persons asphyxiated or overcome by toxic substances. Pre-incident planning is an important factor in preparing to handle these types of incidents.

Due to the inherent dangers associated with these operations, the Phoenix Fire Department *Risk Management Profile* shall be applied to all confined space rescue operations and shall be continuously re-assessed throughout the incident. A phased approach to confined space rescue operations which include; Arrival, Pre-entry operations, Entry operations, and Termination, can be utilized to safely and effectively mitigate these high-risk / low-frequency events.

Additional technical information is available in the issued *Technical Rescue Field Operations Guide*.

**PHOENIX REGIONAL
STANDARD OPERATING PROCEDURES**

CONFINED SPACE RESCUE

M.P. 204.08

07/11-R

PAGE 2 of 8

Phase I Arrival.

I. ESTABLISH COMMAND

- A. First arriving company officer shall assume *Command* and begin an immediate size-up of the situation while isolating the immediate hazard area and denying entry to all non-rescue personnel.
- B. First arriving TRT unit that is staffed with a TRT Company Officer should be assigned *Rescue Sector*. The TRT Company Officer assigned as Rescue Sector should remain with his crew. Rescue Sector responsibilities include:
- Assuming technical rescue operations control.
 - Identifying hazards and critical factors.
 - Developing a rescue plan and back-up plan.
 - Communicating with and directing TRT resources assigned to Rescue Sector.
 - Informing Command of conditions, actions, and needs during all phases of the rescue operation.
- C. Designate a *Safety Officer*. Considerations for Safety Officer include:
- One of the Regional Special Operations qualified Safety Officers.
 - A Special Operations qualified Battalion Chief and/or FIT.
 - Any experienced TRT Company Officer assigned to the incident.

A Safety Officer shall be established prior to the implementation of any rescue plan proposed by Rescue Sector.

- D. Following the transfer of Command to a Command Officer, a *Technical Advisor* should be assigned to join the Command Team at their location to assist in managing personnel and resources engaged in the technical aspects of the incident. The Technical Advisor is responsible for ensuring that the rescue plan developed by Rescue Sector and communicated to Command is a sound plan in terms of the safety and welfare of both victim(s) and rescuers. Considerations for the Technical Advisor include:
- A Special Operations qualified Battalion Chief and/or FIT.
 - One of the Regional Special Operations qualified Safety Officers.
 - Any experienced TRT Company Officer assigned to the incident.

The Technical Advisor position within the Command Team should be filled prior to the implementation of any rescue plan proposed by Rescue Sector.

**PHOENIX REGIONAL
STANDARD OPERATING PROCEDURES**

CONFINED SPACE RESCUE

M.P. 204.08

07/11-R

PAGE 3 of 8

II. Size-Up

- A. Secure a witness or responsible party to assist in gathering information to determine exactly what happened. If no witnesses are present, Command may have to look for clues on the scene to determine what happened.
- B. Assess the immediate and potential hazards to the rescuers.
- C. Isolate immediate hazard area, secure the scene, and deny entry for all non-rescue personnel.
- D. Establish communications with victim(s) and determine if non-entry retrieval can be made.
- E. Assess on-scene capabilities and determine the need for additional resources.

III. SECONDARY ASSESSMENT

- A. Secure the entry permit and any other information about the confined space including diagrams showing entry and egress locations.
- B. Determine what products may be stored in the confined space and conduct a HazMat assessment.
- C. Determine known hazards present in the confined space; atmospheric, mechanical, electrical, etc.
- D. Assess the structural stability of the confined space.

Phase II Pre-entry Operations

It must be determined if this will be a RESCUE operation or a RECOVERY operation based on the survivability profile of the victim(s) which include factors such as the location and condition of the victim(s), and elapsed time since the accident occurred.

Pre-entry operations shall be conducted under the direction of Rescue Sector by trained Technical Rescue Technicians.

I. INITIATE FIRE DEPARTMENT CONFINED SPACE RESCUE PERMIT

- A. A confined space permit is required if the space has one or more of the following hazards:

Atmospheric hazards
Engulfment Hazard

Configuration hazard
Any other recognized hazard

**PHOENIX REGIONAL
STANDARD OPERATING PROCEDURES**

CONFINED SPACE RESCUE

M.P. 204.08

07/11-R

PAGE 4 of 8

II. MAKE THE GENERAL AREA SAFE

- A. Establish a perimeter determined by factors such as atmospheric conditions, wind direction, structural stability, etc.
- B. Consider establishing Lobby to control rescue personnel entering the hazard zone.
- B. Stop all unnecessary traffic and park all running vehicles downwind.
- C. Provide for ventilation to general area if necessary.

III. MAKE THE RESCUE AREA SAFE

A. Hazard Assessment / Atmospheric Monitoring

- Determine exactly what hazards and products are present and conduct atmospheric testing for oxygen level, flammability, and toxicity within the confined space. The hazards identified and the results of atmospheric testing will determine the proper level of PPE to be worn by rescuers.
- Atmospheric monitoring shall be done continuously and readings shall be communicated to Rescue Sector at least every 5 minutes. Readings must be obtained by personnel with a thorough knowledge of atmospheric monitoring. This function shall be assigned to a Hazardous Materials response unit.
- Implement Lock-Out / Tag-Out procedure if applicable.
- Take appropriate measures to ensure the structural stability of the confined space.
- Any product that is in or flowing into the confined space must be secured and blanked off if possible.

B. Ventilation

- Rescue Sector should assign personnel to establish the proper type of mechanical ventilation of the confined space considering the effects that positive and/or negative pressure ventilation will have on the atmosphere.
- Consider positive and negative ventilation together in a push-pull configuration to obtain the greatest effect from ventilation. Consider negative pressure ventilation if there is only one entry point.
- Ventilation personnel shall work closely with air monitoring personnel to ensure safe atmospheric conditions in the confined space as well as the exhaust area and the general working area.

**PHOENIX REGIONAL
STANDARD OPERATING PROCEDURES**

CONFINED SPACE RESCUE

M.P. 204.08

07/11-R

PAGE 5 of 8

C. Equipment

- Personal Protective Equipment (PPE) shall include helmet, gloves, proper footwear, goggles, turnouts / Nomex or PBI jumpsuit, and a class III harness at a minimum. Additional PPE may be indicated by the hazard and atmospheric assessment.
- Supplied Air Breathing Apparatus (SABA) or Self-Contained Breathing Apparatus (SCBA) shall be utilized by all entry and back-up personnel. SABA is the breathing apparatus of choice however, if SCBA must be used, personnel shall maintain line of sight and exit the confined space prior to low air alarm activation, following the 75%-25% rule.
- Air monitoring device that monitors oxygen levels, flammability, and toxicity for the entry team.
- Intrinsically safe communication equipment shall be available for entry personnel. If this equipment is not available, entry personnel may use a tag-line for communication or a message relay person.
- Intrinsically safe lighting equipment shall be available for entry personnel. If this equipment is not available, entry personnel may use cyalume type lighting sticks.
- A retrieval system with a back-up system shall be readied and in place. This may include a vertical or horizontal haul system constructed of ropes, pulleys, and other hardware, with a minimum of a 2:1 mechanical advantage.

Phase III Entry Operations

Entry operations shall be conducted under the direction of Rescue Sector by trained Technical Rescue Technicians.

I. MAKE A SAFE ENTRY

Rescue Sector shall be responsible for entry operations. The rescue plan will be discussed by Rescue Sector, Safety, Command and the Technical Advisor. Rescue Sector shall ensure that all personnel operating in the confined space and the area immediately surrounding the confined space are accounted for and wearing appropriate PPE.

- A. Conduct a system safety check prior to entry into the confined space.**

**PHOENIX REGIONAL
STANDARD OPERATING PROCEDURES**

CONFINED SPACE RESCUE

M.P. 204.08

07/11-R

PAGE 6 of 8

- B. Prior to entry, Rescue Sector shall ensure that an entry team and a back-up team are in place and have been briefed on:
- Anticipated hazards within the confined space.
 - The space being entered including the configuration (if known).
 - The rescue plan.
 - The back-up plan.
 - Emergency procedures.
 - Time limits for the rescue operation.
- C. Consider the use of rescuer tag-lines with the understanding that tag-lines may create an entanglement hazard.
- D. Maintain constant communication with the entry team.
- E. Entry personnel shall continually monitor atmospheric conditions inside the confined space in regards to oxygen level, flammability, and toxicity.
- F. Locate victim(s).

II. VICTIM REMOVAL

- A. Upon reaching victim, conduct a primary survey and initiate C-spine precautions.
NOTE: due to the configuration of the confined space, optimum C-spine precautions may not be possible and should be addressed as soon as possible.
- B. When possible, provide respiratory protection for the victim(s). Rescuers shall not administer pure oxygen to a victim(s) in a confined space that has a potentially flammable atmosphere and rescuers shall not remove their breathing apparatus and give it to the victim(s).
- C. Conduct a secondary survey of the victim(s) looking for immediate life threatening injuries. If conditions permit, entry personnel should attempt to treat serious injuries prior to removal, while considering that it may be more appropriate to remove the victim(s) from danger prior to treatment.
- D. Properly package the patient for removal from the confined space. This may include using a backboard, stokes basket, KED board, LSP halfback, or similar device designed for extrication. Secure any loose webbing buckles, straps, or device that may hinder the extrication process.

**PHOENIX REGIONAL
STANDARD OPERATING PROCEDURES**

CONFINED SPACE RESCUE

M.P. 204.08

07/11-R

PAGE 7 of 8

- E. Rescuers should not allow the victim between the rescuer and the point of egress except in situations where it is necessary for one rescuer to pull the victim while another rescuer pushes the victim.

III. TREATMENT

- A. Immediately upon egress, the victim(s) shall be transferred to treatment personnel for ALS level examination.
- B. If the victim has been contaminated from product inside the confined space, a thorough decontamination of the victim should be conducted prior to transporting to the hospital.
- C. Provide ALS level treatment and transportation to a hospital as indicated.

Phase IV Termination

- A. Ensure personnel accountability.
- B. Remove all tools and equipment used in the rescue/recovery and return to proper apparatus. In cases of a fatality, consider leaving everything in place until the investigative process has been completed.
- C. If entry personnel and/or equipment have been contaminated, proper decontamination procedures shall be followed prior to returning to service.
- D. Consider a Post Incident Critique (may be more appropriate at a later date).
- E. Return to service after turning the scene over to the responsible party and ensuring the scene is secure.

ADDITIONAL CONSIDERATIONS

I. COMMAND STRUCTURE

- A. The first arriving unit shall assume *Command* of the incident. This unit shall remain in Command until Command is transferred to improve the quality of the Command organization. A Command Team shall be assembled to include, at a minimum, a Chief Officer and a Technical Advisor.
- B. Considerations for the *Technical Advisor* include:
- A Special Operations qualified Battalion Chief and/or FIT.
 - One of the Regional Special Operations qualified Safety Officers.
 - Any experienced TRT Company Officer assigned to the incident.

**PHOENIX REGIONAL
STANDARD OPERATING PROCEDURES**

CONFINED SPACE RESCUE

M.P. 204.08

07/11-R

PAGE 8 of 8

- C. The first arriving TRT unit that is staffed with a TRT Company Officer should be assigned *Rescue Sector*. Rescue teams, Lobby, Ventilation, Air monitoring, Shoring, Cut teams, and any other such functional team operating in the hazard zone shall be under the direction of Rescue Sector. Rescue Sector will communicate directly with TRT units assigned to these functions within Rescue Sector and shall keep Command informed during all phases of the rescue operation.
- D. Air monitoring within Rescue Sector shall be assigned to a Hazardous Materials response unit.
- E. Considerations for Safety Officer include:
- One of the Regional Special Operations qualified Safety Officers.
 - A Special Operations qualified Battalion Chief and/or FIT.
 - Any experienced TRT Company Officer assigned to the incident.
- F. Treatment Sector should be assigned to any ALS company assigned to the incident.

II. OTHER CONSIDERATIONS

- A. Consider the effects of inclement weather on the hazard profile, the victim(s), and the rescuers.
- B. Maintain awareness of the time of day and ensure sufficient lighting is available on the scene if operations extend into the night.
- C. Confined Space rescue incidents attract the news media; consider assigning a P.I.O.
- D. Request OSHA response if there has been a serious injury or death.

**PHOENIX REGIONAL
STANDARD OPERATING PROCEDURES**

TRENCH RESCUE OPERATIONS

M.P. 204.09

07/11-R

PAGE 1 of 6

SCOPE

This procedure establishes a standard structure and guideline for all fire department personnel operating at incidents involving trench rescue operations. The procedure outlines responsibilities for first-responders, TRT units, Command Officers, and other fire department personnel responding to such incidents. All other Phoenix Fire Department procedures shall apply to trench rescue operations where applicable.

PURPOSE

The purpose of this procedure is to establish guidelines for the response of fire department personnel and equipment to trench rescue incidents. Because trench rescue operations present a significant danger to fire department personnel, the safe and effective management of these operations require special considerations. *It shall be the policy of the Phoenix Fire Department that NO personnel shall be allowed into an unsafe trench or excavation.* This procedure identifies some of the critical issues which must be included in managing these incidents.

TACTICAL CONSIDERATIONS

OSHA Regulations Standard 29 CFR 1926 Subpart P regulates excavations for general industry and the rescue service and shall be considered the basis for emergency trench rescue operations. For the purpose of emergency response, an excavation shall be defined by any depression, hole, trench, or earth wall, man made or natural, of four feet or greater.

Trench collapses generally occur due to unstable soil conditions combined with improper or inadequate shoring. The potential for additional collapse is considered a primary hazard to personnel. Removing soil or debris, adding weight near the edge of an open cut, vibration (such as vehicle movement), rain, or simply the passage of time, may cause additional collapse at any time during the rescue operation.

Due to the inherent dangers associated with these operations, the Phoenix Fire Department *Risk Management Profile* shall be applied to all trench rescue operations and shall be continuously re-assessed throughout the incident. A phased approach to trench rescue operations which include; Arrival, Pre-entry operations, Entry operations, and Termination, can be utilized to safely and effectively mitigate these high-risk / low-frequency events.

Additional technical information is available in the issued *Technical Rescue Field Operations Guide*.

PHOENIX REGIONAL
STANDARD OPERATING PROCEDURES

TRENCH RESCUE OPERATIONS

M.P. 204.09

07/11-R

PAGE 2 of 6

Phase I Arrival.

I. ESTABLISH COMMAND

- A. First arriving company officer shall assume *Command* and begin an immediate size-up of the situation while ensuring that apparatus remains at least 50 feet from the location of the trench failure. Command shall announce that Level 1 staging should take place at least 150 feet from the trench failure.
- B. First arriving TRT unit that is staffed with a TRT Company Officer should be assigned *Rescue Sector*. The TRT Company Officer assigned as Rescue Sector should remain with his crew. Rescue Sector responsibilities include:
- Assuming technical rescue operations control.
 - Identifying hazards and critical factors.
 - Developing a rescue plan and back-up plan.
 - Communicating with and directing TRT resources assigned to Rescue Sector.
 - Informing Command of conditions, actions, and needs during all phases of the rescue operation.
- C. Designate a *Safety Officer*. Considerations for Safety Officer include:
- One of the Regional Special Operations qualified Safety Officers.
 - A Special Operations qualified Battalion Chief and/or FIT.
 - Any experienced TRT Company Officer assigned to the incident.
- D. Following the transfer of Command to a Command Officer, a *Technical Advisor* should be assigned to join the Command Team at their location, to assist in managing personnel and resources engaged in the technical aspects of the incident. The Technical Advisor is responsible for ensuring that the rescue plan developed by Rescue Sector and communicated to Command is a sound plan in terms of the safety and welfare of both victim(s) and rescuers. Considerations for the Technical Advisor include:
- A Special Operations qualified Battalion Chief and/or FIT.
 - One of the Regional Special Operations qualified Safety Officers.
 - Any experienced TRT Company Officer assigned to the incident.

The Technical Advisor position within the Command Team should be filled prior to the implementation of any rescue plan proposed by Rescue Sector.

**PHOENIX REGIONAL
STANDARD OPERATING PROCEDURES**

TRENCH RESCUE OPERATIONS

M.P. 204.09

07/11-R

PAGE 3 of 6

II. Size-Up

- A. Secure a witness or responsible party to assist in gathering information to determine exactly what happened. If no witnesses are present, Command may have to look for clues on the scene to determine what happened.
- B. Assess the immediate and potential hazards to the rescuers.
- C. Isolate immediate hazard area, secure the scene, and deny entry for all non-rescue personnel.
- D. Assess on-scene capabilities and determine the need for additional resources.

Phase II Pre-entry Operations

It must be determined if this will be a RESCUE operation or a RECOVERY operation based on the survivability profile of the victim(s) which include factors such as the location and condition of the victim(s), and elapsed time since the accident occurred.

I. MAKE THE GENERAL AREA SAFE

- A. Establish a hazard zone perimeter 50 feet from the collapse area.
 - Keep all non-essential rescue personnel out of the hazard zone.
 - Consider establishing Lobby to control rescue personnel entering the hazard zone.
 - Remove all non-essential civilian personnel at least 150 feet away from the collapse area.
- B. Control traffic movement.
 - Shut down roadway.
 - Stage apparatus at least 150 feet from the collapse area.
 - Re-route all non-essential traffic at least 300 feet from the collapse area.
 - Shut down all heavy equipment operating within 300 feet of the collapse area.

II. MAKE THE RESCUE AREA SAFE

These pre-entry operations shall be conducted under the direction of Rescue Sector by trained Technical Rescue Technicians.

- A. Approach the trench from the ends if possible.
- B. Look for unidentified hazards such as fissures or an unstable spoil pile.
- C. Assess the spoil pile for improper angle of repose and general raveling.
- D. Remove any tripping hazards from around the trench.
- E. Place ground pads around the lip of the trench.

**PHOENIX REGIONAL
STANDARD OPERATING PROCEDURES**

TRENCH RESCUE OPERATIONS

M.P. 204.09

07/11-R

PAGE 4 of 6

- F. Secure all hazards in the area: utilities, electric, gas, water, etc.
- G. De-water the trench if necessary.
- H. Monitor the atmosphere in the trench.
- I. Ventilate the trench.

Phase III Entry Operations

Entry operations shall be conducted under the direction of Rescue Sector by trained Technical Rescue Technicians.

Rescue Sector shall be responsible for entry operations. Rescue Sector shall ensure that all personnel operating in the hazard zone are accounted for and wearing appropriate PPE.

I. MAKE THE TRENCH SAFE

- A. Place ingress and egress ladders into the trench. There should be at least 2 ladders placed into the trench no more than 50 feet apart.
- B. Decide on the shoring system to be used (i.e. hydraulic shore, pneumatic shore, timber shore).
- C. Create a safe zone in the non-collapsed area of the trench, from both ends if possible, by implementing an approved shoring system.
- D. Remove dirt from the collapsed zone while remaining in the safe zone.
- E. Secure all utilities, pipe, or other obstructions in the trench.

II. VICTIM REMOVAL / INCIDENTS WITHOUT COLLAPSE

- A. Create a safe zone around the victim.
- B. Remove objects trapping the victim such as pipes, lumber, machinery, etc.
- C. Assess victim's condition.
- D. Properly package the patient and remove from the trench.

III. VICTIM REMOVAL / INCIDENTS WITH COLLAPSE

- A. Begin dirt removal while operating from a safe zone.
- B. Continue extending safe zone into collapse zone.
- C. Create a safe zone around the victim.
- D. Uncover victim to below the diaphragm utilizing small shovels, buckets, or by hand, and assess the victim's condition.
- E. Completely uncover the victim, properly package the patient and remove from the trench.

**PHOENIX REGIONAL
STANDARD OPERATING PROCEDURES**

TRENCH RESCUE OPERATIONS

M.P. 204.09

07/11-R

PAGE 5 of 6

IV. TREATMENT

- A. Conduct a primary survey upon reaching the victim.
- B. Initiate C-spine precautions as soon as possible.
- C. Conduct a secondary survey and correct any life threatening conditions.
- D. Consider removing the victim from danger prior to providing definitive care.
- E. Provide ALS level treatment and transportation to a hospital as indicated.

Phase IV Termination

- A. Ensure personnel accountability.
- B. Remove tools, equipment, and the trench shoring system (last-in / first-out) from the trench. In cases of a fatality, consider leaving everything in place until the investigative process has been completed.
- C. Consider a Post Incident Critique (may be more appropriate at a later date).
- D. Return to service after turning the scene over to the responsible party and ensuring the scene is secure.

ADDITIONAL CONSIDERATIONS

I. COMMAND STRUCTURE

- A. The first arriving unit shall assume *Command* of the incident. This unit shall remain in Command until Command is transferred to improve the quality of the Command organization. A Command Team shall be assembled to include, at a minimum, a Chief Officer and a Technical Advisor.
- B. Considerations for the *Technical Advisor* include:
 - A Special Operations qualified Battalion Chief and/or FIT.
 - One of the Regional Special Operations qualified Safety Officers.
 - Any experienced TRT Company Officer assigned to the incident.

The first arriving TRT unit that is staffed with a TRT Company Officer shall be assigned *Rescue Sector*. Rescue teams, Lobby, Ventilation, Air Monitoring, Shoring, Cut teams, and any other such functional team operating in the hazard zone shall be under the direction of Rescue Sector. Rescue Sector will communicate directly with TRT units assigned to these functions within Rescue Sector and shall keep Command informed during all phases of the rescue operation.

PHOENIX REGIONAL
STANDARD OPERATING PROCEDURES

TRENCH RESCUE OPERATIONS

M.P. 204.09

07/11-R

PAGE 6 of 6

C. Considerations for *Safety Officer* include:

- One of the Regional Special Operations qualified Safety Officers.
- A Special Operations qualified Battalion Chief and/or FIT.
- Any experienced TRT Company Officer assigned to the incident.

D. *Treatment Sector* should be assigned to any ALS company assigned to the incident.

II. OTHER CONSIDERATIONS

- A. Consider the effects of inclement weather on the hazard profile, the victim(s), and the rescuers.
- B. Maintain awareness of the time of day and ensure sufficient lighting is available on the scene if operations extend into the night.
- C. Trench incidents attract the news media; consider assigning a P.I.O.
- D. Request OSHA response if there has been a serious injury or death.

**PHOENIX REGIONAL
STANDARD OPERATING PROCEDURES**

MOUNTAIN RESCUE OPERATIONS

M.P. 204.10

07/11-R

PAGE 1 of 5

SCOPE

This procedure establishes a standard structure and guideline for all fire department personnel operating at incidents involving mountain rescue operations. The procedure outlines responsibilities for first-responders, TRT units, Command Officers, and other fire department personnel responding to such incidents. All other Phoenix Fire Department procedures shall apply to mountain rescue operations where applicable.

PURPOSE

The purpose of this procedure is to establish guidelines for the response of fire department personnel and equipment to mountain rescue incidents which utilize ropes and/or rope systems, or a rescue helicopter, to affect a rescue. Because mountain rescue operations present a significant danger to fire department personnel, the safe and effective management of these operations require special considerations. This procedure identifies some of the critical issues which must be included in managing these incidents.

TACTICAL CONSIDERATIONS

Rope rescue is defined as any rescue attempt that requires rope and/or rope systems and related equipment to safely gain access to, and remove patients from hazardous geographic areas/locations with limited access. The two categories of rescue are:

- Non-Technical - rescues with angles of inclination less than 40°. Most first-responders have the equipment and training to affect this type of rescue.
- Technical - rescues with angles of inclination from 40° to 90°. These rescues typically involve ropes and /or rope systems and shall be performed by rescuers trained to the level of Technical Rescue Technician (TRT).

All rope rescue techniques and equipment utilized in rescue operations shall meet the intent of the following standards as established by the National Fire Protection Association:

- NFPA 1670 *Standard on Operations and Training for Technical Search & Rescue Incidents*
- NFPA 1006 *Standard for Technical Rescuer Professional Qualifications.*
- NFPA 1983 *Standard on Life Safety Rope & Equipment for Emergency Services.*

Due to the inherent dangers associated with these operations, the Phoenix Fire Department *Risk Management Profile* shall be applied to all mountain rescue operations and shall be continuously re-assessed throughout the incident. A phased approach to mountain rescue operations which include; Arrival, Pre-rescue operations, Rescue operations, and Termination, can be utilized to safely and effectively mitigate these high-risk / low-frequency events.

Additional technical information is available in the issued *Technical Rescue Field Operations Guide*.

**PHOENIX REGIONAL
STANDARD OPERATING PROCEDURES**

MOUNTAIN RESCUE OPERATIONS

M.P. 204.10

07/11-R

PAGE 2 of 5

Phase I Arrival.

I. ESTABLISH COMMAND

- A. First arriving company officer shall assume *Command* and begin an immediate size-up of the situation while ascending the mountain with medical equipment to provide treatment for any victim(s) in need of medical care.
- B. First arriving TRT unit that is staffed with a TRT Company Officer should be assigned *Rescue Sector*. The TRT Company Officer assigned as Rescue Sector should remain with his crew and ascend the mountain with the necessary equipment to conduct the rescue. Rescue Sector responsibilities include:
 - Assuming technical rescue operations control.
 - Identifying hazards and critical factors.
 - Developing a rescue plan and back-up plan.
 - Communicating with and directing TRT resources assigned to Rescue Sector.
 - Informing Command of conditions, actions, and needs during all phases of the rescue operation.
- C. Designate a Safety Officer per NFPA 1670. Considerations for Safety Officer include:
 - One of the Regional Special Operations qualified Safety Officers.
 - A Special Operations qualified Battalion Chief and/or FIT
 - Any experienced TRT Company Officer assigned to the incident.
- D. Following the transfer of Command to a Command Officer, a *Technical Advisor* should be assigned to join the Command Team at their location to assist in managing personnel and resources engaged in the technical aspects of the incident. The Technical Advisor is responsible for ensuring that the rescue plan developed by Rescue Sector and communicated to Command is a sound plan in terms of the safety and welfare of both victim(s) and rescuers. Considerations for the Technical Advisor include:
 - A Special Operations qualified Battalion Chief and/or FIT.
 - One of the Regional Special Operations qualified Safety Officers.
 - Any experienced TRT Company Officer assigned to the incident.

The Technical Advisor position within the Command Team should be filled prior to the implementation of any rescue plan proposed by Rescue Sector.

II. Size-Up

- A. Secure a witness or park ranger to assist in gathering information to determine the location and condition of victim(s). If no witnesses are present, and no other source of information is available, Command should consider calling for a police helicopter (Firebird) to locate the victim(s) on the mountain.
- B. Assess the immediate and potential hazards to the rescuers.
- C. Assess on-scene capabilities and determine the need for additional resources.

**PHOENIX REGIONAL
STANDARD OPERATING PROCEDURES**

MOUNTAIN RESCUE OPERATIONS

M.P. 204.10

07/11-R

PAGE 3 of 5

Phase II Pre-rescue Operations

It must be determined if this will be a RESCUE operation or a RECOVERY operation based on the survivability profile of the victim(s) which include factors such as the location and condition of the victim(s), and elapsed time since the accident occurred.

I. MAKE THE RESCUE AREA SAFE

- A. Secure the area and remove all non-essential civilian personnel. If it is not possible to secure all of the hazards, rescue personnel operating in the area must be made aware of the hazard(s).
- B. Control foot traffic on the trail.
- C. Assemble all necessary personnel, rescue equipment, and patient packaging equipment that will be required for the rescue operation.

Phase III Rescue Operations

Technical rescue operations shall be conducted under the direction of Rescue Sector by trained Technical Rescue Technicians.

I. ROPE RESCUE OPERATIONS

Rescue Sector responsibilities shall include the following:

- A. Ensure that all personnel operating in Rescue Sector are accounted for and wearing appropriate PPE.
- B. Develop a rescue plan and a back-up plan.
 - Consider the risk management profile and survivability profile to develop an appropriate rescue plan.
 - The rescue plan shall be developed considering the least amount of risk to rescuers that is necessary to affect the rescue. Low-risk operations are not always possible, but should be considered first.
 - High-risk operations shall be decided upon through consultation with Rescue Sector, Safety, Command, and the Technical Advisor.
 - A back-up plan shall be in place prior to initiating rescue operations.
- C. Ensure the rescue plan and back-up plan, which include emergency procedures, are communicated to all personnel operating on the incident.

II. HELICOPTER OPERATIONS

Helicopter operations are considered high-risk and shall be decided upon through consultation with Rescue Sector, Safety, Command, and the Technical Advisor. Factors to consider in the use of a rescue helicopter include:

- Condition of the patient.
- Difficult access.
- Difficult terrain.
- Time of day.
- Environmental effects on rescuers.

**PHOENIX REGIONAL
STANDARD OPERATING PROCEDURES**

MOUNTAIN RESCUE OPERATIONS

M.P. 204.10

07/11-R

PAGE 4 of 5

NOTE: Prior to considering the use of a helicopter for rescue operations, Command must determine if a rescue-qualified pilot is available for the rescue operation. If so, the Pilot In Command (PIC) will have the final say on *if* and *how* the helicopter will be used in the rescue operation.

In addition to the responsibilities described for rope rescue, Rescue Sector shall also be responsible for the following:

- A. Establish a Base LZ in an appropriate location.
 - Assign this function to a TRT response unit.
- B. Establish a Mountain LZ in designated mountain locations.
 - Assign this function to TRT personnel on the mountain. Call for additional resources if necessary.

III. TREATMENT

- A. Conduct a primary survey upon reaching the victim.
- B. Initiate C-spine precautions as soon as possible.
- C. Conduct a secondary survey and correct any life threatening conditions.
- D. Consider removing the victim from danger prior to providing definitive care.
- E. Provide ALS level treatment and transportation to a hospital when indicated.

Phase IV Termination

- A. Ensure personnel accountability.
- B. Descend the mountain with personnel and equipment. In cases of a fatality, consider leaving everything in place until the investigative process has been completed.
- C. Consider a Post Incident Critique (may be more appropriate at a later date).
- D. Return to service after returning all equipment to apparatus.

ADDITIONAL CONSIDERATIONS

I. COMMAND STRUCTURE

- A. The first arriving unit shall assume *Command* of the incident. This unit shall remain in Command until Command is transferred to improve the quality of the Command organization. A Command Team shall be assembled to include, at a minimum, a Chief Officer and a Technical Advisor.
- B. Considerations for the *Technical Advisor* include:
 - A Special Operations Qualified Battalion Chief and/or FIT.
 - One of the Regional Special Operations qualified Safety Officers.
 - Any experienced TRT Company Officer assigned to the incident.

**PHOENIX REGIONAL
STANDARD OPERATING PROCEDURES**

MOUNTAIN RESCUE OPERATIONS

M.P. 204.10

07/11-R

PAGE 5 of 5

- C. The first arriving TRT unit that is staffed with a TRT Company Officer should be assigned *Rescue Sector*. Rescue teams, Base LZ, Mountain LZ, and any other such functional team operating on the mountain shall be under the direction of Rescue Sector. Rescue Sector will communicate directly with TRT units assigned to these functions within Rescue Sector and shall keep Command informed during all phases of the rescue operation.
- D. Considerations for *Safety Officer* include:
- One of the Regional Special Operations qualified Safety Officers.
 - A Special Operations Qualified Battalion Chief and/or FIT.
 - Any experienced TRT Company Officer assigned to the incident.
- E. *Treatment Sector* can be assigned to the first non-TRT unit that ascends the mountain.
- II. OTHER CONSIDERATIONS
- A. Consider the effects of inclement weather on the hazard profile, the victim(s), and the rescuers.
- B. Rescuers shall be “on-rope” and “tied-in” when operating near an edge.
- C. Victims should be secured in a harness or litter so as not to fall out if inverted at any time during the rescue operation.
- D. Mountain rescue incidents attract the news media; consider assigning a P.I.O.

**PHOENIX REGIONAL
STANDARD OPERATING PROCEDURES**

WATER RESCUE OPERATIONS

M.P. 204.11

07/11-R

PAGE 1 of 6

SCOPE

This procedure establishes a standard structure and guideline for all fire department personnel operating at incidents involving water rescue operations. The procedure outlines responsibilities for first-responders, TRT units, Command Officers, and other fire department personnel responding to such incidents. All other Phoenix Fire Department procedures shall apply to water rescue operations where applicable.

PURPOSE

The purpose of this procedure is to establish guidelines for the response of fire department personnel and equipment to water rescue incidents. Because water rescue operations present a significant danger to fire department personnel, the safe and effective management of these operations require special considerations. This procedure identifies some of the critical issues which must be included in managing these incidents.

TACTICAL CONSIDERATIONS

Due to the inherent dangers associated with these operations, the Phoenix Fire Department *Risk Management Profile* shall be applied to all water rescue operations and shall be continuously re-assessed throughout the incident. A phased approach to water rescue operations which include; Arrival, Pre-rescue operations, Rescue operations, and Termination, can be utilized to safely and effectively mitigate these high-risk / low-frequency events.

Additional technical information is available in the issued *Technical Rescue Field Operations Guide*.

Phase I Arrival.

I. ESTABLISH COMMAND

- A. First arriving company officer shall assume *Command* and begin an immediate size-up of the situation.
- B. First arriving TRT unit that is staffed with a TRT Company Officer should be assigned *Rescue Sector*. The TRT Company Officer assigned as Rescue Sector should remain with his crew. Rescue Sector responsibilities include:
 - Assuming technical rescue operations control.
 - Identifying hazards and critical factors.
 - Developing a rescue plan and back-up plan.
 - Communicating with and directing TRT resources assigned to Rescue Sector.
 - Informing Command of conditions, actions, and needs during all phases of the rescue operation.

**PHOENIX REGIONAL
STANDARD OPERATING PROCEDURES**

WATER RESCUE OPERATIONS

M.P. 204.11

07/11-R

PAGE 2 of 6

- C. Designate a *Safety Officer*. Considerations for Safety Officer include:
- One of the Regional Special Operations qualified Safety Officers.
 - A Special Operations qualified Battalion Chief and/or FIT.
 - Any experienced TRT Company Officer assigned to the incident.
- D. Following the transfer of Command to a Command Officer, a *Technical Advisor* should be assigned to join the Command Team at their location to assist in managing personnel and resources engaged in the technical aspects of the incident. The Technical Advisor is responsible for ensuring that the rescue plan developed by Rescue Sector and communicated to Command is a sound plan in terms of the safety and welfare of both victim(s) and rescuers. Considerations for the Technical Advisor include:
- A Special Operations qualified Battalion Chief and/or FIT.
 - One of the Regional Special Operations qualified Safety Officers.
 - Any experienced TRT Company Officer assigned to the incident.

The Technical Advisor position within the Command Team should be filled prior to the implementation of any rescue plan proposed by Rescue Sector.

II. Size-Up

- A. Secure a witness to assist in gathering information to determine exactly what happened and the location of any victim(s). If no witnesses are present, Command may have to look for clues on the scene to determine what happened.
- B. Assess the immediate and potential hazards to the rescuers.
- C. Isolate immediate hazard area, secure the scene, and deny entry for all non-rescue personnel.
- D. Assess on-scene capabilities and determine the need for additional resources.

Phase II Pre-rescue Operations

It must be determined if this will be a RESCUE operation or a RECOVERY operation based on the survivability profile of the victim(s) which include factors such as the location and condition of the victim(s), and elapsed time since the accident occurred.

I. MAKE THE GENERAL AREA SAFE

- A. Establish a hazard zone perimeter.
- B. Keep all non-essential rescue personnel out of the hazard zone.

**PHOENIX REGIONAL
STANDARD OPERATING PROCEDURES**

WATER RESCUE OPERATIONS
M.P. 204.11 07/11-R PAGE 3 of 6

- C. Remove all non-essential civilian personnel at least 150 feet away from the hazard zone.

II. MAKE THE RESCUE AREA SAFE

All personnel operating at or near the water shall be in proper personal protective equipment (PPE) which will include at a minimum: personal flotation device (PFD), approved water rescue helmet, and approved footwear.

- A. Identify hazards that are present which include but are not limited to:

- The volume of water.
- The velocity of the water.
- Debris in the water.
- Hydraulics.
- Depth of the water – rising / falling.

- B. Assign personnel upstream.

- Rescue personnel shall be assigned upstream to advise Rescue Sector of any upstream hazards that may affect the rescue operation.

- C. Assign personnel downstream.

- Rescue personnel shall be assigned downstream with throw bags to capture rescue personnel or victim(s) that may be washed downstream.

- D. Assemble all necessary personnel, equipment, and patient packaging equipment that will be required for the rescue operation.

Phase III Rescue Operations

Technical rescue operations shall be conducted under the direction of Rescue Sector by trained Technical Rescue Technicians.

I. RESCUE SECTOR

Rescue Sector responsibilities shall include the following:

- Ensure that all personnel operating in Rescue Sector are accounted for and wearing appropriate PPE.
- Develop a rescue plan and a back-up plan.
- Ensure the plan and back-up plan, which include emergency procedures, are communicated to all personnel operating on the incident.

**PHOENIX REGIONAL
STANDARD OPERATING PROCEDURES**

WATER RESCUE OPERATIONS
M.P. 204.11 07/11-R PAGE 4 of 6

II. THE RESCUE PLAN

Rescue operations should be conducted with as little risk to the rescuers as necessary to affect the rescue. Low-risk operations may not always be possible but should be considered first. The order of rescue from low-risk to high-risk are:

- A. TALK – if water is calm or slow moving, try to talk the victim into self-rescue if possible.
- B. REACH – extend an arm, pike pole, rescue hook, or any other such object to reach the victim and pull from the water.
- C. THROW – attempt to throw the victim(s) a throw-bag rescue line or some other type of approved safety flotation device and “pendulum-belay” or “haul” the victim(s) to the bank.
- D. ROW - If it is determined that a boat-based operation shall be utilized, Rescue Sector shall assign a company on the opposite bank to assist in establishing an anchor for an approved rope system.
- E. GO - If it is not possible to row to the victim, Rescue Sector should consider putting a rescuer or rescuers in the water to reach the victim. This is a very high risk operation and shall be conducted exclusively by trained TRT personnel. Prior to entering the water, rescue personnel shall be briefed on the plan, the back-up plan and emergency procedures. Rescue personnel shall never be attached to a life line without the benefit of a quick-release mechanism approved for water rescue. Rescue personnel shall never do a “breath-hold” surface dive in an attempt to locate a victim beneath the surface of the water.
- F. HELO - Helicopter operations are considered high-risk and shall be decided upon through consultation with Rescue Sector, Safety, Command, and the Technical Advisor. Prior to considering the use of a helicopter for rescue operations, Command must determine if a rescue-qualified pilot is available for the rescue operation. If so, the Pilot In Command (PIC) will have the final say on *if* and *how* the helicopter will be used in the rescue operation.

III. ASSESS THE VICTIM

When the rescuers reach the victim, a primary survey shall be completed. If the victim is conscious, rescuers should determine if the victim can assist in the rescue. If the victim is unconscious, the rescue must be completed as quickly as possible.

**PHOENIX REGIONAL
STANDARD OPERATING PROCEDURES**

WATER RESCUE OPERATIONS

M.P. 204.11

07/11-R

PAGE 5 of 6

IV. TREATMENT

- A. Initiate C-spine precautions as soon as possible.
- B. Conduct a secondary survey and correct any life threatening conditions.
- C. Provide for ALS level treatment and transportation to a hospital as indicated.

Phase IV Termination

- A. Ensure personnel accountability.
- B. Consider decontamination of victim(s) and rescuer(s).
- C. Recover all tools and equipment used in the rescue/recovery. In cases of a fatality, consider leaving everything in place until the investigative process has been completed.
- D. Consider a Post Incident Critique (may be more appropriate at a later date).
- E. Return to service after returning all equipment to apparatus.

ADDITIONAL CONSIDERATIONS

I. COMMAND STRUCTURE

- A. The first arriving unit shall assume *Command* of the incident. This unit shall remain in Command until Command is transferred to improve the quality of the Command organization. A Command Team shall be assembled to include, at a minimum, a Chief Officer and a Technical Advisor.
- B. Considerations for the *Technical Advisor* include:
 - A Special Operations qualified Battalion Chief and/or FIT.
 - One of the Regional Special Operations qualified Safety Officers.
 - Any experienced TRT Company Officer assigned to the incident.
- C. The first arriving TRT unit that is staffed with a TRT Company Officer should be assigned *Rescue Sector*. Rescue teams, Upstream, Downstream, and any other such functional team operating near the water shall be under the direction of Rescue Sector. Rescue Sector shall communicate directly with TRT units assigned to the various functions within Rescue Sector and shall keep Command informed during all phases of the rescue operation.

**PHOENIX REGIONAL
STANDARD OPERATING PROCEDURES**

WATER RESCUE OPERATIONS

M.P. 204.11

07/11-R

PAGE 6 of 6

D. Considerations for *Safety Officer* include:

- One of the Regional Special Operations qualified Safety Officers.
- A Special Operations qualified Battalion Chief and/or FIT.
- Any experienced TRT Company Officer assigned to the incident.

E. *Treatment Sector* should be assigned to any ALS company assigned to the incident.

II. OTHER CONSIDERATIONS

A. Consider the effects of inclement weather and water conditions on the hazard profile, the victim(s), and the rescuers, with particular attention to the effects of hypothermia.

B. Water rescue incidents attract the news media; consider assigning a P.I.O.

**PHOENIX REGIONAL
STANDARD OPERATING PROCEDURES**

STRUCTURAL COLLAPSE RESCUE OPERATIONS

M.P. 204.12

07/11-R

PAGE 1 of 7

SCOPE

This procedure establishes a standard structure and guideline for all fire department personnel operating at incidents involving structural collapse rescue operations. The procedure outlines responsibilities for first-responders, TRT units, Command Officers, and other fire department personnel responding to such incidents. All other Phoenix Fire Department procedures shall apply to structural collapse rescue operations where applicable.

PURPOSE

The purpose of this procedure is to establish guidelines for the response of fire department personnel and equipment to structural collapse rescue incidents. Because structural collapse rescue operations present a significant danger to fire department personnel, the safe and effective management of these operations require special considerations. This procedure identifies some of the critical issues which must be included in managing these incidents.

TACTICAL CONSIDERATIONS

Due to the inherent dangers associated with these operations, the Phoenix Fire Department *Risk Management Profile* shall be applied to all structural collapse rescue operations and shall be continuously re-assessed throughout the incident. A phased approach to structural collapse rescue operations which include; Arrival, Pre-rescue operations, Rescue operations, and Termination, can be utilized to safely and effectively mitigate these high-risk / low-frequency events.

Additional technical information is available in the issued *Technical Rescue Field Operations Guide*.

Phase I Arrival.

During the Arrival phase of a structural collapse incident, Command must take strong control of the incident to prevent the situation from quickly deteriorating into a chaotic event. A structural collapse incident is likely to have unorganized, volunteer rescue efforts being conducted by civilian personnel which creates an unsafe situation for the volunteers as well as rescuers. Command must focus attention early on building a strong Command structure that will ensure the safety of rescue personnel and support this complex campaign operation.

I. ESTABLISH COMMAND

- A. First arriving company officer shall assume *Command* and begin an immediate size-up of the situation.
- B. First arriving TRT unit that is staffed with a TRT Company Officer should be assigned *Rescue Sector*. The TRT Company Officer assigned as *Rescue Sector* should remain with his crew. *Rescue Sector* responsibilities include:
 - Assuming technical rescue operations control.
 - Identifying hazards and critical factors.
 - Developing a rescue plan and back-up plan.
 - Communicating with and directing TRT resources assigned to *Rescue Sector*.
 - Informing Command of conditions, actions, and needs during all phases of the rescue operation.

**PHOENIX REGIONAL
STANDARD OPERATING PROCEDURES**

STRUCTURAL COLLAPSE RESCUE OPERATIONS

M.P. 204.12

07/11-R

PAGE 2 of 7

- C. Designate a *Safety Officer*. Considerations for Safety Officer include:
- One of the Regional Special Operations qualified Safety Officers.
 - A Special Operations qualified Battalion Chief and/or FIT.
 - Any experienced TRT Company Officer assigned to the incident.
- D. Following the transfer of Command to a Command Officer, a *Technical Advisor* should be assigned to join the Command Team at their location to assist in managing personnel and resources engaged in the technical aspects of the incident. The Technical Advisor is responsible for ensuring that the rescue plan developed by Rescue Sector and communicated to Command is a sound plan in terms of the safety and welfare of both victim(s) and rescuers. Considerations for the Technical Advisor include:
- A Special Operations qualified Battalion Chief and/or FIT.
 - One of the Regional Special Operations qualified Safety Officers.
 - Any experienced TRT Company Officer assigned to the incident.

The Technical Advisor position within the Command Team should be filled prior to the implementation of any rescue plan proposed by Rescue Sector.

II. Size-Up

- A. Spot apparatus outside of any potential secondary collapse zone.
- B. Secure a witness or responsible party to assist in gathering information to determine exactly what happened. If no witnesses are present, Command may have to look for clues on the scene to determine what happened.
- C. Assess the immediate and potential hazards to the rescuers. Hazards associated with structural collapse include:
- Secondary collapse.
 - Explosion and fire.
 - Broken gas and water lines.
 - Energized electrical lines.
 - Falling debris.
- D. Isolate immediate hazard area, secure the scene, and deny entry for all non-rescue personnel.
- E. Assess on-scene capabilities and determine the need for additional resources. Consider establishing Level 2 staging and calling for heavy machinery and equipment such as cranes and front-end loaders.

Phase II Pre-rescue Operations

The Phoenix Fire Department is the sponsoring agency of AZ-TF1, which is one of 28 FEMA Urban Search & Rescue task forces in the nation. This team is highly trained and equipped to respond to incidents involving structural collapse. Consideration should be given to utilize the personnel and equipment from this task force for incidents involving structural collapse.

**PHOENIX REGIONAL
STANDARD OPERATING PROCEDURES**

STRUCTURAL COLLAPSE RESCUE OPERATIONS

M.P. 204.12

07/11-R

PAGE 3 of 7

I. MAKE THE GENERAL AREA SAFE

A. Establish a hazard zone perimeter around the collapse area.

- Keep all non-essential rescue personnel out of the hazard zone.
- Remove all non-essential civilian personnel at least 150 feet away from the hazard zone perimeter.

II. MAKE THE RESCUE AREA SAFE

A. Secure all hazards. If it is not possible to secure all hazards, rescue personnel operating in the area must be made aware of the hazard(s).

B. Establish a Lobby Sector. Command should establish a Lobby Sector to control the flow and maintain personnel accountability of rescue personnel in the collapse area.

C. Establish a Treatment Sector. Command should establish a Treatment Sector to identify and set-up a triage and treatment area a safe distance from the collapse area for the treatment and transportation of victims.

D. Establish a Building Triage team. Rescue Sector should establish a Building Triage team which shall consist of a Technical Rescue Technician trained and knowledgeable in structural collapse shoring techniques, a structural engineer, and a Hazardous Materials Technician. This team will assess the structural integrity and hazardous conditions of the building(s) involved and will utilize a building marking system to indicate their findings. Consider establishing additional Building Triage teams if the area of collapse is widespread and involves numerous buildings.

E. Establish a Search team. Rescue Sector should establish a Search team to search the collapse area and locate victims. A Search team shall consist of TRT personnel trained in the use of specialized search equipment, and search canines with their handlers (if available). Consider establishing additional Search teams if the area of collapse is widespread and involves numerous buildings.

F. Establish a Rescue team. A Rescue Team shall consist of TRT personnel trained in the use of specialized rescue equipment and techniques. Consider establishing additional Rescue teams if the area of collapse is widespread and involves numerous buildings.

G. Establish a transportation corridor. Command shall ensure roadways are clear in and out of the collapse site so that apparatus and other heavy equipment and machinery have access to the site. Consider establishing a liaison with the Police Department to accomplish this function.

Phase III Rescue Operations

Technical rescue operations shall be conducted under the direction of Rescue Sector by trained Technical Rescue Technicians.

**PHOENIX REGIONAL
STANDARD OPERATING PROCEDURES**

STRUCTURAL COLLAPSE RESCUE OPERATIONS

M.P. 204.12

07/11-R

PAGE 4 of 7

I. RESCUE SECTOR

Rescue Sector responsibilities shall include the following:

- Ensure that all personnel operating in Rescue Sector are accounted for and wearing appropriate PPE.
- Develop a rescue plan and a back-up plan.
- Ensure the plan and a back-up plan, which include emergency procedures, are communicated to all personnel operating on the incident.

II. THE RESCUE PLAN

Rescue operations should be conducted with as little risk to the rescuers as necessary to affect the rescue. Low-risk operations may not always be possible but should be considered first. The rescue plan shall be developed through consultation with Rescue Sector, Safety, Command, and the Technical Advisor. The plan and a back-up plan, which include emergency procedures, shall be communicated to all personnel operating on the incident.

III. THE RESCUE

- A. Remove surface victims. First responders should be assigned to remove victims and the “walking wounded” from the surface of the collapse area. Rescuers shall use extreme caution during the early stages of rescue operations due to significant hazards which have not yet been identified. Following the removal of surface victims and the “walking wounded”, all rescue personnel should be removed from the collapse area and a personnel accountability report (PAR) shall be obtained. This will allow for a re-grouping of rescue personnel and the implementation of a detailed search and rescue plan to locate and remove any other victims from the collapse area.

After surface victims and the “walking wounded” have been removed from the collapse area, all non-TRT rescue personnel shall be removed from the collapse area and Technical Rescue operations shall begin under the direction of Rescue Sector by trained Technical Rescue Technicians.

- B. Building Triage. Assign the Building Triage team to identify, select, and prioritize the building(s) with the highest probability of success with respect to finding and rescuing live victims. Additionally, the Building Triage team shall be responsible for using a building marking system to indicate structural conditions and hazards present to search and rescue personnel.
- C. Locate victims. Following the structural and hazard assessment by the Building Triage team, the Search team(s) shall be assigned to locate entrapped victims by utilizing search canines (if available), and specialty search equipment such as search cameras and acoustic listening devices. Search teams shall not enter buildings which have been determined to be structurally unsafe until appropriate shoring and stabilization measures have been taken.

**PHOENIX REGIONAL
STANDARD OPERATING PROCEDURES**

STRUCTURAL COLLAPSE RESCUE OPERATIONS

M.P. 204.12

07/11-R

PAGE 5 of 7

- D. Extricate entrapped victims. Once the Search team has located an entrapped victim, the Rescue team(s) shall be responsible for utilizing their specialized rescue equipment and techniques to extricate victims from the collapse area. The breaking and breaching of walls, floors and roofs, will typically be associated with shoring and other methods of stabilization which make these operations manpower and resource intensive. Consider calling for additional resources and establishing a Resource Sector. Rescue teams shall not enter buildings which have been determined to be structurally unsafe until appropriate shoring and stabilization measures have been taken.
- E. Selected debris removal. If the Search team(s) has not been able to locate victims through other methods, or if a victim location is known, either by credible witness or search team verification, debris may be selectively removed to gain access to the victim and/or otherwise unsearchable locations within the collapse area. Special care must be exercised while removing debris to avoid a secondary collapse. Heavy equipment such as a crane may be necessary to accomplish selected debris removal. The selected debris removal process should be stopped periodically to conduct search operations for additional victims. Once the debris has been removed and search operations determine that there are no other victims in the area, rescue personnel shall be accounted for and removed from the area.
- F. General debris removal. Once it has been determined that no other live victims can be located in the collapse area, a general debris removal operation may be started. Removal crews shall be alert to possible deceased victims and/or victim body parts and the coroner and/or other investigative personnel shall be notified to handle the removal of the remains. As debris is removed, each load should be marked as to the general location found and final location of the debris to aid in the investigative process. Command may elect to turn general debris removal over to the responsible party (RP) for final disposition of the building. If this option is exercised, the RP should be informed as to the proper handling of debris for investigative purposes.

IV. TREATMENT

- A. Conduct a primary survey upon reaching the victim.
- B. Initiate C-spine precautions as soon as possible.
- C. Conduct a secondary survey and correct any life threatening conditions.
- D. Consider removing the victim from danger prior to providing definitive care.
- E. Provide ALS level treatment and transportation to a hospital as indicated.

**PHOENIX REGIONAL
STANDARD OPERATING PROCEDURES**

STRUCTURAL COLLAPSE RESCUE OPERATIONS

M.P. 204.12

07/11-R

PAGE 6 of 7

Phase IV Termination

- A. Ensure personnel accountability.
- B. Consider decontamination of rescuers.
- C. Recover all tools and equipment used in the rescue/recovery. In cases of a fatality, consider leaving everything in place until the investigative process has been completed.
- D. Consider a Post Incident Critique (may be more appropriate at a later date).
- E. Return to service after returning all equipment to apparatus.

ADDITIONAL CONSIDERATIONS

I. COMMAND STRUCTURE

- A. The first arriving unit shall assume *Command* of the incident. This unit shall remain in Command until Command is transferred to improve the quality of the Command organization. A Command Team shall be assembled to include, at a minimum, a Chief Officer and a Technical Advisor.
- B. Considerations for the *Technical Advisor* include:
 - A Special Operations qualified Battalion Chief and/or FIT.
 - One of the Regional Special Operations qualified Safety Officers.
 - Any experienced TRT Company Officer assigned to the incident.
- C. The first arriving TRT unit that is staffed with a TRT Company Officer should be assigned *Rescue Sector*. Building Triage team, Search team, Rescue team, and any other such functional team operating in the collapse area shall be under the direction of Rescue Sector. Rescue Sector shall communicate directly with TRT units assigned to the various functions within Rescue Sector and shall keep Command informed during all phases of the rescue operation.
- D. Considerations for *Safety Officer* include:
 - One of the Regional Special Operations qualified Safety Officers.
 - A Special Operations qualified Battalion Chief and/or FIT.
 - Any experienced TRT Company Officer assigned to the incident.
- E. *Treatment Sector* should be assigned to any ALS company assigned to the incident.

PHOENIX REGIONAL
STANDARD OPERATING PROCEDURES

STRUCTURAL COLLAPSE RESCUE OPERATIONS

M.P. 204.12

07/11-R

PAGE 7 of 7

II. OTHER CONSIDERATIONS

- A. Structural collapse incidents may present rescuers with a confined space situation. Prior to entering any space, the atmosphere in that space must be monitored by a qualified Hazardous Materials Technician with an appropriate air monitoring device to determine if the space is safe to enter. If the atmosphere is determined to be unsafe, it must be changed and made safe prior to any entry. If the atmosphere cannot be changed, and entry must be made to retrieve a viable victim, rescue personnel shall follow M.P. 204.08 *Confined Space Rescue Operations* to ensure the safety of rescue personnel entering the space. Rescue Sector must be informed of any confined space rescue operation and will keep Command informed of the operation.
- B. Rescue teams should consider the effects of lifting/moving heavy objects off victims and have ALS level treatment available at the rescue site.
- C. Consider the effects of inclement weather on the hazard profile, the victim(s), and the rescuers.
- D. Incidents involving structural collapse will attract the news media; consider assigning a P.I.O.

**PHOENIX REGIONAL
STANDARD OPERATING PROCEDURES**

TREE RESCUE OPERATIONS

M.P. 204.13

07/11-R

PAGE 1 of 5

SCOPE

This procedure establishes a standard structure and guideline for all fire department personnel operating at incidents involving tree rescue operations. The procedure outlines responsibilities for first-responders, TRT units, Command Officers, and other fire department personnel responding to such incidents. All other Phoenix Fire Department procedures shall apply to tree rescue operations where applicable.

PURPOSE

The purpose of this procedure is to establish guidelines for the response of fire department personnel and equipment to tree rescue incidents. Because tree rescue operations present a significant danger to fire department personnel, the safe and effective management of these operations require special considerations. This procedure identifies some of the critical issues which must be included in managing these incidents.

TACTICAL CONSIDERATIONS

Due to the inherent dangers associated with these operations, the Phoenix Fire Department *Risk Management Profile* shall be applied to all tree rescue operations and shall be continuously re-assessed throughout the incident. A phased approach to tree rescue operations which include; Arrival, Pre-rescue operations, Rescue operations, and Termination, can be utilized to safely and effectively mitigate these high-risk / low-frequency events.

Phase I Arrival.

I. ESTABLISH COMMAND

- A. First arriving company officer shall assume *Command* and begin an immediate size-up of the situation.
- B. First arriving TRT unit that is staffed with a TRT Company Officer should be assigned *Rescue Sector*. The TRT Company Officer assigned as Rescue Sector should remain with his crew. Rescue Sector responsibilities include:
 - Assuming technical rescue operations control.
 - Identifying hazards and critical factors.
 - Developing a rescue plan and back-up plan.
 - Communicating with and directing TRT resources assigned to Rescue Sector.
 - Informing Command of conditions, actions, and needs during all phases of the rescue operation.
- C. Designate a *Safety Officer*. Considerations for Safety Officer include:
 - One of the Regional Special Operations qualified Safety Officers.
 - A Special Operations qualified Battalion Chief and/or FIT.
 - Any experienced TRT Company Officer assigned to the incident.

**PHOENIX REGIONAL
STANDARD OPERATING PROCEDURES**

TREE RESCUE OPERATIONS

M.P. 204.13

07/11-R

PAGE 2 of 5

D. Following the transfer of Command to a Command Officer, a *Technical Advisor* should be assigned to join the Command Team at their location to assist in managing personnel and resources engaged in the technical aspects of the incident. The Technical Advisor is responsible for ensuring that the rescue plan developed by Rescue Sector and communicated to Command is a sound plan in terms of the safety and welfare of both victim(s) and rescuers. Considerations for the Technical Advisor include:

- A Special Operations qualified Battalion Chief and/or FIT.
- One of the Regional Special Operations qualified Safety Officers.
- Any experienced TRT Company Officer assigned to the incident.

The Technical Advisor position within the Command Team should be filled prior to the implementation of any rescue plan proposed by Rescue Sector.

II. Size-Up

- A. Secure a witness or responsible party to assist in gathering information to determine exactly what happened. If no witnesses are present, Command may have to look for clues on the scene to determine what happened.
- B. Assess the immediate and potential hazards to the rescuers.
- C. Isolate immediate hazard area, secure the scene, and deny entry for all non-rescue personnel.
- D. Assess on-scene capabilities and determine the need for additional resources.

Phase II Pre-rescue Operations

It must be determined if this will be a RESCUE operation or a RECOVERY operation based on the survivability profile of the victim(s) which include factors such as the location and condition of the victim(s), and elapsed time since the accident occurred.

I. MAKE THE GENERAL AREA SAFE

- A. Establish a hazard zone perimeter 50 feet around the tree.
 - Keep all non-essential rescue personnel out of the hazard zone.
 - Remove all non-essential civilian personnel at least 150 feet away from the tree.

II. MAKE THE RESCUE AREA SAFE

- A. Maintain awareness of all electrical lines in the vicinity.
- B. Watch for falling debris, branches, or tree skirt which can become particularly problematic during windy conditions.

**PHOENIX REGIONAL
STANDARD OPERATING PROCEDURES**

TREE RESCUE OPERATIONS

M.P. 204.13

07/11-R

PAGE 3 of 5

C. Identify any other hazards that are present and ensure they are secured and made safe.

Phase III Rescue Operations

Technical rescue operations shall be conducted under the direction of Rescue Sector by trained Technical Rescue Technicians.

I. RESCUE SECTOR

Rescue Sector responsibilities shall include the following:

- Ensure that all personnel operating in Rescue Sector are accounted for and wearing appropriate PPE.
- Develop a rescue plan and a back-up plan.
- Ensure the plan and back-up plan, which include emergency procedures, are communicated to all personnel operating on the incident.

II. THE RESCUE PLAN

Rescue operations should be conducted with as little risk to the rescuers as necessary to affect the rescue. Low-risk operations may not always be possible but should be considered first. The order of rescue from low-risk to high-risk are:

A. Self-rescue.

If possible, talk the victim into self-rescue. Place a ground ladder or aerial platform ladder under the victim and then coach the victim to climb down.

B. Aerial Platform Ladder Truck.

Rescue personnel should consider any hazards such as power lines hidden in the tree, the angle of the ladder, and the distance an aerial platform ladder needs to extend to reach the victim. When possible, consider removing obstacles that may be in the way of an aerial platform ladder truck.

C. Ground Ladders.

If it is not possible to reach the victim with an aerial platform ladder truck, ground ladders should be placed against the tree. The first ladder should go under the victim; the second ladder should go along side and slightly above the victim. Both ladders should be secured to the tree. A piece of webbing or small piece of rope works well for securing the ladder to the tree.

**PHOENIX REGIONAL
STANDARD OPERATING PROCEDURES**

TREE RESCUE OPERATIONS

M.P. 204.13

07/11-R

PAGE 4 of 5

D. Climb the Tree.

If aerial platform ladder truck placement and ground ladder placement is not possible, the victim must be reached by climbing the tree. Tree climbing with approved equipment shall only be performed by trained TRT members. Rescue Sector shall assign two rescuers the task of climbing the tree and affecting the rescue. Consider that it may be necessary to remove fronds or branches from the tree to reach the victim and that tree climbing is a high-risk operation.

III. ASSESS THE VICTIM

When the rescuers reach the victim, a primary survey shall be completed and a determination as to the exact method of entrapment must be made. If the victim is conscious, rescuers should determine if the victim can assist in the rescue. If the victim is unconscious, the rescue must be completed quickly.

IV. RESCUE THE VICTIM

One rescuer should climb above and to the side of the victim and establish a point of attachment for a lowering system. At the same time, the other rescuer should climb to the victim and attach or "capture" the victim onto an approved rescue harness. On the ground, an approved and appropriate anchor and lowering system shall be established. Once the lowering system has been attached to the victim, the victim shall be disentangled from the tree, which may include cutting away any system the victim used to climb the tree, and lowered to the ground.

V. TREATMENT

- A. Complete a secondary survey on the victim.
- B. Provide for ALS level treatment and transportation to a hospital as indicated.

Phase IV Termination

- A. Ensure personnel accountability.
- B. Recover all tools and equipment used in the rescue/recovery. In cases of a fatality, consider leaving everything in place until the investigative process has been completed.
- C. Consider a Post Incident Critique (may be more appropriate at a later date).
- D. Return to service after returning all equipment to apparatus.

**PHOENIX REGIONAL
STANDARD OPERATING PROCEDURES**

TREE RESCUE OPERATIONS

M.P. 204.13

07/11-R

PAGE 5 of 5

ADDITIONAL CONSIDERATIONS

I. COMMAND STRUCTURE

- A. The first arriving unit shall assume *Command* of the incident. This unit shall remain in Command until Command is transferred to improve the quality of the Command organization. A Command Team shall be assembled to include, at a minimum, a Chief Officer and a Technical Advisor.
- B. Considerations for the *Technical Advisor* include:
- A Special Operations qualified Battalion Chief and/or FIT.
 - One of the Regional Special Operations qualified Safety Officers.
 - Any experienced TRT Company Officer assigned to the incident.
- C. The first arriving TRT unit that is staffed with a TRT Company Officer should be assigned *Rescue Sector*. Rescue Sector shall communicate directly with TRT units assigned to the various functions within Rescue Sector and shall keep Command informed during all phases of the rescue operation.
- D. Considerations for *Safety Officer* include:
- One of the Regional Special Operations qualified Safety Officers.
 - A Special Operations qualified Battalion Chief and/or FIT.
 - Any experienced TRT Company Officer assigned to the incident.
- E. *Treatment Sector* should be assigned to any ALS company assigned to the incident.

II. OTHER CONSIDERATIONS

- A. Consider the effects of inclement weather on the hazard profile, the victim(s), and the rescuers.
- B. Tree rescue incidents attract the news media; consider assigning a P.I.O.

PHOENIX REGIONAL
STANDARD OPERATING PROCEDURES

COMMUNICATIONS

M.P. 205.01

10/10-R

Page 1 of 16

DISPATCH POLICY

The Phoenix Fire Department will respond to any EMERGENCY situation that threatens **LIFE, SAFETY or PROPERTY**. In cases where the fire department is not the appropriate agency or not capable of delivering the needed assistance, or if the situation is not a true emergency, an attempt will be made to place the caller in contact with the appropriate provider. The fire department will dispatch the closest available unit(s) with the required capabilities to control the emergency. The judgment of both Phoenix Fire Department Regional Dispatch Center (PFDRDC) and emergency response personnel is an integral part of the decision making process, taking into consideration both the information received and the potential that exists.

Timely response and effective management of EMS, rescue and fire control situations represent the most immediate priorities of the fire department. Upon receipt of adequate or additional information (location, telephone callback and nature of the emergency), Deployment will dispatch the appropriate assignment and upgrade the response as necessary based on information received up to a Working First Alarm until command is established upon the arrival of the first unit.

JURISDICTION

Emergency incidents within the Automatic Aid boundaries served by the PFDRDC will be dispatched without regard to jurisdiction. Units will also be dispatched to borderline locations when Deployment personnel cannot make accurate determination of the jurisdiction.

PFDRDC has enhanced mutual aid with Rural/Metro Fire Department (RMFD) within one (1) mile of the borders of Scottsdale and Phoenix in the Northeast portion of the Valley. Rural/Metro units and Automatic Aid Consortium units can be dispatched into these areas without prior approval when the CAD system recognizes a RMFD unit is closer in these areas.

PFDRDC has enhanced mutual aid for requests by Gila River Indian Community Fire Department for incidents that occur on I10 from Phoenix city limits to mile post 169; within two and one-half (2.5) miles from the border of the Gila River Indian Community and the cities of Chandler and Phoenix in Maricopa County; within one (1) mile of the border of the Gila River Indian Community, the City of Chandler, and the Sun Lakes Fire Districts in Pinal County.

PFDRDC has one (1) way Automatic Aid onto Luke Air Force Base (LAFB). CAD has been programmed to select LAFB units for any calls that fall within a five (5) mile radius of the base. CAD will also select the next available unit to respond.

Calls for assistance from public or quasi-public agencies outside the Automatic Aid Consortium boundaries will be dispatched as Mutual Aid incidents with the approval of the individual jurisdiction's on-duty BC or the on-duty Phoenix Fire Department Shift Commander if Phoenix resources are needed.

Calls for assistance from citizens outside the Automatic Aid Consortium boundaries will be transferred to the appropriate agency. If that agency requests Mutual Aid assistance, PFDRDC will contact the appropriate jurisdiction for approval of the Mutual Aid request and dispatch accordingly.

PHOENIX REGIONAL
STANDARD OPERATING PROCEDURES

COMMUNICATIONS

M.P. 205.01

10/10-R

Page 2 of 16

CALL ROUTING

Determination of the nature of the problem may indicate that a caller does not have an emergency that requires a fire department response. The identification, prevention and reduction of unnecessary responses are basic parts of the Deployment function. The call routing process must not delay response to valid emergency incidents but should attempt to verify the nature of questionable calls. When a positive determination of need for emergency response cannot be made **THE FIRE DEPARTMENT POLICY IS TO DISPATCH.**

CALLTAKER

The primary responsibility of the Calltaker is to determine, without delay, the location, telephone callback and nature of the emergency and to verify entry of the incident into the CAD system.

NATURE CODES

The Calltaker assigns a Nature Code based on information gathered from the caller. Once the Calltaker enters the incident for dispatch, the CAD system selects available units by capability and proximity to fulfill the response requirements of the assignment. Automatic Aid Consortium members have the ability to modify response types for each Nature Code on file. The Phoenix Fire Department attempts to streamline this process and works to maintain consistency however; the Phoenix Fire Department understands that some variations are needed to meet the specific needs of the jurisdictions.

UNIT SELECTION

The CAD system recommends the closest, most appropriate unit/s/ for dispatch based on availability, current location and capabilities. The CAD system combines this information with the response type.

A response type is assigned to each Nature Code. The response type identifies the requirements needed on the assignment. Requirements can be identified by unit capability, such as engine or ladder, or by specific unit, such as BC2. Requirements are also expressed as primary or secondary. A unit can fulfill only one primary requirement. A unit can fulfill more than one secondary requirement.

When an incident is selected for dispatch, the CAD system builds an ordered unit consideration list. As a unit is considered for dispatch, its capabilities are inventoried against the outstanding response requirements. If it can satisfy any outstanding requirement it is added to the recommendation. The CAD system will continue to add units to the recommendation until all response requirements have been satisfied or all units have been exhausted. Some unit capabilities have distance limitations added to requirements. The system will not send certain types of units if they are out of the predetermined response range.

RESPONSE ASSIGNMENTS

The Calltaker makes initial determination of the appropriate Nature Code based on information received from the caller. Individual jurisdictions may customize the primary and secondary response requirements on a given Nature Code. CAD will automatically dispatch the required units per Nature Code entered for each jurisdiction. The RSPREQ command may be utilized to determine the specific primary and secondary response requirements per Nature Code for an individual jurisdiction:

Format: RSPREQ *Nature Code, Jurisdiction Code* (3 letters)
Example: RSPREQ STR1A, PHX

ALS Medical Calls

The requirements for ALS response are based on Emergency Medical Dispatch protocol (EMD).

PHOENIX REGIONAL
STANDARD OPERATING PROCEDURES

COMMUNICATIONS

M.P. 205.01

10/10-R

Page 3 of 16

BLS Medical Calls

All medical calls are triaged using EMD protocols. On BLS responses the Company Officer will make a C2 or C3 response decision and press the appropriate response on the MCT. If the response is modified and sent as ALS when the caller provides additional information that meets the ALS criterion, the calls defaults to C3. The ALS response criterion is different for each Nature Code.

Minor Medical Calls

The patient has to meet the following criteria; no loss of consciousness, peripheral injuries only, head/face; arm: below elbow; leg: below knee, no trunk injuries, no impaled objects, no amputations, no severe bleeding.

Violent Medical Calls

The incident has been determined unsafe to respond directly to the scene. Units assigned to the incident shall stage until the Police Department secures the scene.

Airport Incidents

The alert classifications of aircraft emergencies are distinguished by the Federal Aviation Administration to describe an unsafe condition or situation involving an aircraft. The Fire Department Captain from Station 19 will identify the appropriate ARFF assignment to be dispatched on any aircraft emergency at Sky Harbor Airport. The default assignment to Sky Harbor Airport is **ARF2-1**.

Fire Incidents

Incidents that require or potentially require water capabilities to extinguish a fire.

Fire Incidents (3-1's)

A 3-1 assignment will be dispatched for structure fires that do not indicate the need for a First Alarm assignment.

Fire Incidents - First Alarms

A First Alarm will be dispatched for structure fires when reports indicate this level of resource are needed. This may be based on reports that indicate an actual or potential situation. A First Alarm may be dispatched for other types of incidents at the discretion of Dispatch personnel.

Brush Fires

Brush assignments will be dispatched for reported vegetation fires. A Still Brush assignment will be dispatched for vegetation fires that are small in nature. A Brush assignment will be dispatched for vegetation fires that are serious in nature. A First Alarm Brush assignment will be dispatched for vegetation fires that are and/or have the potential to be a major situation requiring this level of resources.

Hazardous Materials

Hazardous Materials assignments will be dispatched for incidents reported to involve hazardous materials. Hazardous Materials situations MAY include fire, spills, transportation accidents, chemical reactions, explosions and/or similar events. Hazards may include toxicity, flammability, radiological hazards, chemical reactions and/or combinations of factors.

PHOENIX REGIONAL
STANDARD OPERATING PROCEDURES

COMMUNICATIONS

M.P. 205.01

10/10-R

Page 4 of 16

Hazardous Materials cont'd

A HAZ assignment will be dispatched on calls that involve hazardous materials of a minor nature. A HAZ2-1 assignment should be dispatched on most situations involving leaks or spills of hazardous materials. This includes situations that appear to be manageable and do not create a major risk to the public by virtue of location, amount or type of hazard. A HAZ1A assignment should be dispatched for incidents that indicate a major potential danger by virtue of materials involved, quantities, location, fire or explosion danger and/or number of people exposed.

Technical Rescue

Incidents that may require specialized equipment and training to extricate the patient(s). These incidents include confined space rescue, trench rescue, high angle or rope rescue, water rescue, structural collapse, mountain and tree rescues.

Service Calls and Other Miscellaneous Incidents

Service Calls will also be dispatched for non-emergency situations. Deployment will select the appropriate Nature Code that best describes the situation. Some service calls require the Calltaker to determine a C2 or C3 response.

SUPPLEMENTAL DISPATCH

Depending on the resources required additional units may be dispatched to an incident in several methods. Units can be Special Called, an assignment can be Balanced or a Greater Alarm can be requested.

Special Call

A Special Call is a request for the dispatch of any combination of additional unit types, unit capabilities or specific units. The requestor must specify the desired quantity of unit types or capabilities or the specific units desired.

When formulating a recommendation for a special call, no consideration is given to the units already assigned to the incident. All response requirements for the special call request are satisfied by the recommendation of additional units.

Balance of Assignment

A balance of assignment is a request for the dispatch of the additional units necessary to upgrade the response type. Either the desired response type or a specific Nature Code must be specified. If a Nature Code is specified, the CAD system will determine the response type based on the specified Nature Code and the jurisdiction in which the incident is located.

When formulating a recommendation for a Balance of an assignment, the CAD system first determines which response requirements for the new response type are satisfied by the units that are already assigned to the incident. The CAD system then recommends additional units to satisfy any outstanding response requirement.

Greater Alarm

A Greater Alarm is a request for the dispatch of additional units using predefined requirement sets. A Greater Alarm request requires both a **Greater Alarm Type** and the **Response Level**.

PHOENIX REGIONAL
STANDARD OPERATING PROCEDURES

COMMUNICATIONS

M.P. 205.01

10/10-R

Page 5 of 16

Greater Alarm cont'd

When formulating a recommendation for a Greater Alarm, no consideration is given to the units already assigned to the incident. The Response Level indicated satisfies all response requirements for the Greater Alarm. Assignments should be balanced up to and including a Working First Alarm. When an assignment is Balanced, the system takes into consideration the units currently assigned to the incident. Therefore, an incident can go from a single engine response, such as a tree fire and be Balanced to a Working First Alarm allowing the system to fulfill all requirements necessary for the Working First Alarm. This however does not occur for Greater Alarms. A 3-1 assignment that needs the resources of a Greater Alarm must first be Balanced to a Working Fire Alarm then the Greater Alarm request must be generated.

Response Levels do not have to be equivalent to Alarm Levels, however, often times they are. The response level requested for a Greater Alarm request should reflect the level of resources required, not necessarily the next alarm level.

Example: An incident may be a Third Alarm Structure and may require the components of a Hazardous Assignment. The assumption is to ask for a Fourth Alarm Hazardous. If, however, a Fourth Alarm Hazardous were requested, no Hazardous Materials capabilities would be added to the assignment. At this point, a Second Alarm Hazardous must be requested.

Specific Types of Second Alarms

Second Alarms are dispatched at the request of command, when the need is indicated. Command should ask for the specific type alarm needed to continue managing the incident: If a First Alarm Brush is being used and Command wants to provide relief for crews, Command should call for a Second Alarm Rehab.

The following are valid codes for Greater Alarms:

BRUSH	BRUSH ASSIGNMENT
HAZMAT	HAZARDOUS MATERIALS ASSIGNMENT
HIRISE	HIRISE ASSIGNMENT
MED	MEDICAL ASSIGNMENT
REHAB	REHAB ASSIGNMENT
RESCUE	RESCUE ASSIGNMENT
STRUCT	STRUCTURAL ASSIGNMENT
STRMED	STRUCTURAL/MED

Greater Alarms

Third Alarms and greater still require a specific type of alarm to be requested; however the capabilities recommended will be generic and are the same for each Greater Alarms up to a Ninth Alarm.

DISPATCH CHANNEL 1

The Channel 1 dispatcher is responsible for reviewing the unit/s/ suggested for dispatch by the CAD system. The dispatcher may modify the unit selection based on additional information or circumstantial factors.

The dispatcher transmits the call to the assigned units by depressing the DISPATCH button, sending the information to the Fire Station Packages and Mobile Computer Terminals (MCTs).

PHOENIX REGIONAL
STANDARD OPERATING PROCEDURES

COMMUNICATIONS

M.P. 205.01

10/10-R

Page 6 of 16

Normal Dispatch

The voice dispatch message is broadcast over Fire Channel 1 giving:

- Dispatch Tone
- Companies Assigned
- Tactical Radio Channel
- Type and/or Nature of Incident
- Location
- Companies Assigned
- Tactical Radio Channel

DURING PERIODS OF HIGH ACTIVITY THE DISPATCH MESSAGE MAY BE MODIFIED TO ADVISE UNITS TO CHECK MCT's FOR DISPATCH.

Immediate Dispatch

Specific high priority Nature Codes are flagged for Immediate Dispatch upon incident entry. Additionally, Calltakers have the ability to cause any incident to be dispatched immediately upon entry in the CAD system. During an Immediate Dispatch the station terminals and MCT's will receive the dispatch information as soon as the Calltaker enters the call. The Voice Dispatch will occur when the call is processed through Channel 1. The time elapsing between Station Alerting and Voice Dispatch will depend upon the level of activity at the dispatch position.

Working Incident Notifications

Deployment will sound the ALL CALL tone and make a general announcement over Dispatch Channel 1 of the following incidents:

- Working First Alarm fires
- Greater Alarms
- At the discretion of the on-duty Deployment BC and/or Supervisor

Change of Status

All companies are in either in an AVAILABLE or UNAVAILABLE status at all times. The status refers to the company's availability to accept a dispatch. Units assigned to an incident are considered UNAVAILABLE until released. The exception to this is during AOI calls; see 'Responding' section for further details.

Units that are Available on Radio (AOR) or Available Out of Vehicle (AOV) shall monitor Channel 1.

Units changing their status to UNAVAILABLE should report to Deployment by radio on Tactical Channel 2 or telephone the reason and the length of time they will be unavailable. When becoming available again, units are responsible to report this status change to Deployment.

It is important that company officers contact Deployment prior to putting their unit unavailable. Deployment will determine if any priority needs exist which may require the unit to stay in service.

MOVE-UP POLICY

The on-duty Deployment Supervisor/Battalion Chief is responsible for relocating units as necessary to maintain the best available resource coverage for the entire dispatch jurisdictional coverage area. This responsibility includes the authority to request companies from the Automatic Aid Consortium and to control or cancel scheduled and non-scheduled non-emergency activities. NOTE: Members assigned to Adaptive Response units should refer to M.P. 205.09 Adaptive Response Units.

PHOENIX REGIONAL
STANDARD OPERATING PROCEDURES

COMMUNICATIONS

M.P. 205.01

10/10-R

Page 7 of 16

MOVE-UP POLICY cont'd

Moved-up companies retain their normal identity ("Engine 14 out of Station 30").

The need for move-up companies will be evaluated whenever:

- A working fire is declared.
- Three (3) or more units are committed to an incident in an outlying area.
- Greater Alarms are dispatched.
- Simultaneous working incidents occur in one area of the City.
- Coverage in an area is compromised.
- Two (2) or more adjacent first due areas will be uncovered for more than 30 minutes.

Move-ups will be C2 unless advised to respond C3 due to a critical gap in coverage.

If overall coverage in the City of Phoenix falls below 12 engine companies and three (3) ladder companies, Deployment will immediately notify the South Shift Commander who has the responsibility to authorize the recall of off duty personnel to staff reserve companies if necessary.

TACTICAL RADIO OPERATOR (TRO)

The TRO handles all communications between units assigned to an incident and Deployment on the assigned Tactical Channel. All units responding to an incident shall switch to the assigned channel immediately after dispatch.

Self Dispatch

Units may add themselves to an incident by an AU function on their MCT. Companies adding on to an assignment must advise the TRO on the assigned Tactical Channel if they are substituting for another unit or responding in addition to the original assignment. The TRO will cancel the original unit dispatched if the substituting unit is closer to the scene.

The TRO will advise the Command Officer of units responding in addition to the dispatched assignment. The updated dispatch message will be transmitted to all responding units via MCT.

Acknowledgement

All units responding to an incident shall acknowledge dispatch by radio on the assigned tactical channel or by Mobile Computer Terminal (MCT).

If Deployment does not receive an acknowledgment within one (1) minute, the TRO will request acknowledgment by radio on all channels and via MCT.

Deployment will send a cover assignment if no reply is received within a two (2) minute timeframe. Deployment will continue to attempt to make contact with the original company while the cover unit is responding. If unable to contact the original unit, the company will be placed unavailable and the appropriate Battalion Chief notified of the circumstances.

PHOENIX REGIONAL
STANDARD OPERATING PROCEDURES

COMMUNICATIONS

M.P. 205.01

10/10-R

Page 8 of 16

Responding

All fire and ALS EMS responses will be C3 unless otherwise indicated by Deployment or Command. Units responding to calls on the freeways will proceed C2. BLS Nature Codes will be dispatched without a C2 or C3 response flag. The company officer will make the determination to respond after reviewing the dispatch information. Minor medical incidents and some service calls will be dispatched C2/Available on Incident (AOI). The AOI feature allows a company assigned to a low priority incident to be preempted for a higher priority call if they are the closest unit. This occurs automatically on pre-identified AOI type calls and when a unit is in a responding mode.

If the company officer makes the decision to respond C2 on a C3 call, he/she must advise his/her TRO or press C2 on his/her MCT and send. Similarly, if the company officer makes the decision to respond C3 on a C2 call, he/she must advise his/her TRO or press C3 on his/her MCT and send.

A unit dispatched on a C2 AOI call will automatically become AOI after acknowledging response to the initial call. After acknowledgement they will remain AOI until they arrive on the scene. If a unit is responding longer than ten (10) minutes on an AOI call, CAD will automatically place the unit in the Unavailable On Incident (UOI) status, and they will no longer be considered for preemption. Once a unit places themselves on-scene of an incident, they are no longer considered available for dispatches until they return to an available status.

- If a company officer determines they do not want to be AOI while responding, they may indicate they are traveling C3 to the incident via radio or MCT. If the company officer determines they do not want to be AOI while responding C2 to the incident, they may use the MCT command UOI. This command will show the unit responding C2 however the unit will not be available for preemption.
- Once a company arrives on-scene of an incident and have determined they could leave the call promptly to take another call, they can place themselves AOI again either via radio or MCT.

While responding, companies may communicate with one another if radio traffic permits. Effective communications during this period can set the stage for effective action and improve the overall rescue and fire attack effort. Factors such as occupancy hazards, access, traffic conditions and response routes may be communicated.

Company officers should review tactical information on their MCT, map books and any pre-fire planning information carried on the vehicle for specific tactical information. Subsequent arriving units should monitor radio traffic to be fully informed of the situation based on reports of the first arriving units.

Additional Information / Subsequent Calls

The TRO will relay any additional information gained from subsequent calls as soon as possible. Additional information and updates will be transmitted to the MCTs of all responding units.

Companies needing specific additional information shall request it from the TRO.

COMMUNICATIONS

M.P. 205.01

10/10-R

Page 9 of 16

On-scene Reports

The first fire department member or unit to arrive at the scene of a multiple unit response shall assume command of the incident*. The initial Incident Commander shall remain in Command until Command is transferred or the incident is stabilized and Command is terminated.

- One or two company responses that are not going to escalate beyond the commitment of these companies do not require the first arriving unit or officer to assume Command. The first arriving unit or officer will, however remain responsible for any needed Command functions. Examples would include:
 - ❖ Single unit response Check Welfare
 - ❖ Check Hazard
 - ❖ Any EMS call requiring only one or two companies

The first arriving fire department unit initiates the command process by giving an initial radio report.

The standard **Initial Radio Report** includes:

On-Scene Report

1. Clear alarm.
2. Unit designation/on the scene.
3. Building/area description.
 - Occupancy
 - Size (large, medium, small)
 - Height (assumed 1 story unless reported otherwise)
4. Obvious problem/conditions.
 - Nothing showing (indicates checking)
 - Smoke showing (amount and location)
 - Fire showing (amount and location)
 - Working fire
 - Fully involved
5. Action taken.
 - Assuming command
 - Laying a line
 - Attacking with...etc.
6. Declaration of Strategy.
 - Offensive or Defensive
7. Command confirmation with name

COMMUNICATIONS

On-Scene Report cont'd

Examples:

For an offensive structure fire -

Engine 11 to Alarm - "Engine 11 is on the scene of a large two story school with a working fire on the second floor. Engine 11 is laying a supply line and going in with a hand-line to the second floor for search & rescue and fire attack. This is an offensive fire attack. Engine 11 will be 7th Street Command."

For a defensive fire -

Engine 11 to Alarm - "Engine 11 is on the scene of a medium size warehouse fully involved with exposures to the east. Engine 11 is laying a supply line and attacking the fire with a stang gun and a hand-line to the east exposure to check for extension. This is a defensive fire. Engine 11 will be Buckeye Command."

For an E.M.S. incident -

Ladder 11 to Alarm - "Ladder 11 is on the scene with a multi-vehicle accident. Give me the balance of a 2 and 1 medical with three ambulances. Ladder 11 will be Parkway Command."

Follow-up Report

1. Any immediate safety concerns
2. Accountability started (announce the initial accountability location)
3. Disposition of resources (hold/add/return)
4. IRIC - in place and identify

Examples:

For an offensive structure fire -

7th Street Command to Alarm - "Engine 11 will be North side accountability. Give me the balance a 1st Alarm; Engine 11 has an IRIC in place."

For a defensive fire -

Buckeye Command to Alarm – "Engine 11 will be South side accountability. Give me the balance of a 1st Alarm".

For an E.M.S. incident – Parkway Command to Alarm – "be advised we have a total of 3 patients, 2 Immediates and 1 delayed. All patients have been extricated".

COMMUNICATIONS

M.P. 205.01

10/10-R

Page 11 of 16

Command

Once command has been established, all routine communication between Deployment and an incident will be directed through Command.

Progress Reports

During active firefighting operations, Command will provide Deployment with regular progress reports or whenever significant tactical plans are changed or unusual situations are encountered. The first progress report should be given after initial action has been implemented and should include the correct address and an improved description of the building and fire conditions if the arrival report was incomplete. This assists Deployment in making move-up decisions. The TRO will repeat significant facts from all progress reports for the information of monitoring units and document in the incident history.

Working Fire

The term Working Fire indicates a situation that will require the commitment of all responding companies. This report advises Deployment that the companies will be engaged in tactical activities and will be held at the scene for an extended period of time.

When notified of a Working 3-1, Deployment will:

1. Dispatch a Working Fire assignment (WF)
2. Address the need for a Fire Investigator.
3. Dispatch PD for traffic and crowd control.
4. Dispatch appropriate gas and electric companies.
5. Change the status to a Working Fire, which starts elapsed time notifications.
6. Make move-ups to affected area
7. Document progress reports, sectors, assignments, emergency traffic, and elapsed time notifications and append additional information provided from Deployment members in the Incident History.

When notified of a Working First Alarm, Deployment will:

1. Dispatch a Working Fire assignment (WF1A)
2. Isolate tactical channel
3. Dispatch a Fire Investigator
4. Dispatch PD for traffic and crowd control
5. Dispatch gas and electric companies
6. Make move-ups to affected area
7. Document progress reports, Sectors/Divisions/Groups, assignments, emergency traffic, and elapsed time notifications and append additional information provided from Deployment members in the Incident History.
8. Be prepared to assign a TRO to monitor/work Staging and Safety Sectors/Divisions channels.
9. Be prepared to dispatch further assistance.
10. Be prepared to dispatch any special agencies or equipment when the need is indicated.
11. Make notifications to pertinent personnel.

Deployment will monitor radio traffic on all incidents to anticipate the needs of Command.

Any fire at a school facility requires the State Fire Marshall to be contacted. The on-duty State Fire Marshall will use his/her discretion as to response.

PHOENIX REGIONAL
STANDARD OPERATING PROCEDURES

COMMUNICATIONS

M.P. 205.01

10/10-R

Page 12 of 16

Staging

Units arriving in Staging will depress the "STG" key on their MCT. If assigned to a sector or task on the fireground the "ON-SCENE" key shall be depressed.

Units arriving in Level I Staging will report their identity and direction from the scene on the assigned Tactical Channel.

Upon the balance of a working Second Alarm assignment, Level II Staging will be identified by Command. Deployment will announce Level II staging location and the staging channel when the additional units are dispatched. Units responding should direct any staging inquiries to the Staging channel, rather than the Tactical channel assigned to the incident. Typically Staging will be assigned to Channel 2. The driver of the CV will coordinate information on the Staging channel until an officer assumes the position of the Staging Officer. Units arriving at the Level II Staging Area will report in person to the Staging Officer. The Staging Officer will manage all radio communications to and from the Staging Area.

Incident Status & Milestones

The following are the different incident status changes that need to be indicated: Working Fire (WF), Working Haz Mat (WHZ), Working Technical Rescue (WTR), Code (CO), or Major Medical (MM). When one (1) of these incidents are identified by command, the TRO will enter a specific command. For Working Fire and Working Haz Mat incidents, this change will prompt ELAPSED TIME NOTIFICATIONS. The system will generate an elapsed time notification every five (5) minutes until the incident is placed Under Control. The TRO will verbally provide command with elapsed time notifications until the situation is declared under control or Command requests to discontinue notifications. Elapsed Time Notifications will also be documented in the Incident History.

The following are the definitions of the Incident Milestones:

906: Fire unit/s/ need immediate police department assistance.

All Clear (AC): Can be used on a fire or medical incident. On fire calls an All Clear indicates the fire building and all exposures have been searched and all civilians evacuated. In the case of a building that is well involved in fire, the All Clear may be delayed and not come until the fire is out. For medical calls, it indicates the patient has been extricated. It is used most commonly when patients have been trapped as a result of an automobile accident or during a water or mountain rescue when the patient has been removed from the endangered area.

CO Below 50ppm (CO): Level of carbon monoxide is below 50 parts per million, units may operate without SCBA protection.

Command Terminated (CT): There is no longer a single person in charge of the incident. Communications can be held with anyone still on the scene.

Command Terminated (XCM) – Also referred to as Cancel Command. There is no longer a single person in charge of the incident. This milestone is used after CT and removed the Command designator from the unit.

Defensive (DEF): Units operating in the defensive strategy.

Emergency Traffic (ETT): Emergency Traffic has been declared on an incident

COMMUNICATIONS

M.P. 205.01

10/10-R

Page 13 of 16

Incident Status & Milestones definitions cont'd

Extended Patient Transfer (EPT): Patient transfer from Rescue personnel to hospital is greater than 30 minutes.

Extrication Complete (EC): All patients extricated.

Immediates Transported (IT): All patients triaged as an "immediate" have been transported.

Incident Transition Complete (ITC): Transferring of channel assignment from Trunked to Simplex or vice versa

Loss Stopped (LS): Salvage has been completed and there should be no more damage to the building involved.

Mayday (MAY): A Mayday has been declared on an incident.

Offensive (OFF): Units operating in the offensive strategy.

Patient Contact (PC): First unit has made contact with patient.

Patient Contact ALS (PCA): First ALS unit has made contact with patient.

Patient Contact BLS (PCB): First BLS unit has made contact with patient.

Patient Contact Rescue (PCR): Rescue has made contact with patient.

Phone Patch (PP): Phone patch established with Medical control.

Rescue Contact (RC): Rescue has made contact with patient.

Personnel Accountability Report (PAR): All personnel assigned to a particular work area or sector has been accounted for. It is used to confirm there are no missing fire personnel on the incident site.

Primary All Clear (PAC): Primary search has been completed.

Secondary All Clear (SAC): A more comprehensive search of the building has been completed.

Triage Complete (TC): All patients have been triaged.

Transfer Channel Acknowledgment (TCA): Unit acknowledgment of channel assignment change from Trunked to Simplex or vice versa

Under Control (UC): The fire has been contained, and will not extend. It does not mean the fire is out. It may also be used during Haz Mat calls, indicating a leak has been secured.

Utilities Secured (US): The power has been shut off to the occupant.

Ventilation Complete (VC): The task of ventilation has been completed.

PHOENIX REGIONAL
STANDARD OPERATING PROCEDURES

COMMUNICATIONS

M.P. 205.01

10/10-R

Page 14 of 16

RETURNING COMPANIES

Only Command can release companies assigned to an incident. Command will indicate the units to "HOLD" at the scene, report the nature of the actual situation found and release the remainder of the assignment. The TRO will repeat this report from Command and document the "HOLD" command in the incident history. Returning units will be responsible for placing their unit in an AOR status when available.

SECTORS/DIVISIONS/GROUPS

NOTE: Sectors may be assigned by their geographic location (North Sector) or function (Ventilation Sector). Divisions are assigned by their geographic location (North Division). Groups are assigned by their function (Ventilation Group). For the remainder of this MP we will refer to Sectors with the understanding that either Divisions or Groups may be used where appropriate.

Sector Officers should use face-to-face communications with assigned companies as much as possible, but should keep Command informed of progress via radio on any problems encountered and significant progress.

Command may assign Sector Officer's FITs to a designated Safety Channel when desired to enhance overall scene safety.

CAD SECTOR COMMANDS

The TRO should ensure that each unit that is assigned to a Sector is documented using the Sector Commands. The TRO will enter the appropriate command to designate a Sector Officer (SECTO), a Sector Member (SECTM) or to remove a unit from a sector (SECTX). Using these commands allows both the TRO and Incident Commander to track the assignment of units during the incident. The TRO can designate a sector ID of up to six (6) alphanumeric characters.

Example: SECTO E3 INTER or SECTM E2 INTER

STAFF

Staff members with fireground responsibilities will respond to Greater Alarms for assistance with various sector functions. Staff members will report in person to the Command Post and will automatically assume sector duties in their area of responsibility unless ordered otherwise.

Communications from staff personnel should be with command as much as possible; however, there will be situations that require direct communications with sector officers. Staff communications should be face to face as much as possible.

An isolated Tactical Channel will be assigned by Deployment for each incident where applicable. Command may also request a "Clear Channel" for a working incident. When requested, Deployment will direct units on other incidents to an alternate Tactical Channel.

PHOENIX REGIONAL
STANDARD OPERATING PROCEDURES

COMMUNICATIONS

M.P. 205.01

10/10-R

Page 15 of 16

ORDER MODEL

Radio communications will be regulated by the following order model guidelines.

1. Sender will give unit ID and call the receiver by their unit ID.
2. Receiver will give their ID to indicate they are ready to receive.
3. Sender will then extend message, order, etc.
4. Receiver will give ID and acknowledge receipt of message. A brief restatement is the best acknowledgment.
5. Deployment will acknowledge all communications directed to it by a brief restatement of the message, with particular attention given to repeating on the scene, size-up and progress reports, recall reports, requests for additional resource and all Incident Status changes and milestones.

MAY DAY

"May Day" is a term to be used only in the event of a lost or trapped firefighter. (See "May Day" Communications for further details.) A well-defined communications structure is essential in any rescue operation. Deployment will play a crucial role in ensuring the effective rescue of firefighters.

EMERGENCY TRAFFIC

The term 'Emergency Traffic' will be utilized by any unit encountering an immediately perilous situation and will receive the highest communications priority from Deployment, Command and all operating units. Units may initiate emergency communications by depressing the red emergency button on their portable radio, MCT, or by verbally contacting Deployment.

EXAMPLE: 'L11 to Alarm with Emergency Traffic'. Deployment will immediately activate the Emergency Traffic tone. The unit will transmit his/her message. Deployment will repeat message one (1) time and document in the Incident History.

If Deployment does not acknowledge Emergency Traffic the unit should then establish contact with Command and transmit the emergency message. Command will then re-initiate the Emergency Traffic sequence with Deployment.

WITHOUT EXCEPTION THE AIR BELONGS TO ANY UNIT WITH 'EMERGENCY TRAFFIC'

UNIT DESIGNATION

For radio communications, the following designations will be recognized as standard:

Dispatch & Deployment	Dispatch (Alarm)
Officer of any unit	Unit ID
Engineer of any pumper	Pump
Engineer of any ladder	Truck
Firefighter on any unit	E1, FF Smith
Battalion Chiefs	Battalion
Battalion Field Incident Technician	Battalion FIT
Shift Commander	South Deputy, North Deputy

PHOENIX REGIONAL
STANDARD OPERATING PROCEDURES

COMMUNICATIONS

M.P. 205.01

10/10-R

Page 16 of 16

RADIO CODE

"Plain language" radio messages should be used in preference to numerical codes to facilitate understanding. There is no official Phoenix Fire Department radio code. This is also in compliance with NIMS.

The following code messages (from the Police radio code) may be used in sensitive situations, when a plain language message could cause a problem at the scene:

261	Rape
901-H	Dead body
906	Need Police assistance IMMEDIATELY
961	Vehicle accident, no injuries
962	Vehicle accident, with injuries
963	Vehicle accident with fatality

RADIO PROCEDURE

Short-specific

Before transmitting know what you are going to say. Choose precise terms to communicate the desired message as clearly and briefly as possible without wasting airtime.

Task Oriented/Company Oriented

Command's orders to operating companies should indicate a specific task assigned to the company. They should be of a magnitude reasonably performed by a single company alone or in concert with other companies.

Indicate Objective

In addition to being task and company oriented, assignments should indicate an objective to the action. The company should know exactly where to go, to whom to report, what is the task and what is the objective of the task. Orders should tell what to do - not how to do it (unless Command wants something specific).

Clear Tone/Self Control Effective Rate

Speak clearly at a practiced rate. Not too fast and not too slow. Control your emotions and excitement deliberately. If you do not consciously control your voice, it will become garbled under stress.

Well Timed/Spaced

Prioritize your messages. Do not use valuable airtime with unimportant messages and insignificant details.

Maintain an awareness of the overall situation and your role in it.

Do not interrupt conversations unless you have Emergency Traffic. Listen before transmitting and wait until a message transaction has been completed.

Pause between consecutive messages. This will make it clear when one message has been completed and another started. It also allows other units to break in with urgent/emergent traffic if applicable.

**PHOENIX REGIONAL
STANDARD OPERATING PROCEDURES**

EMS DISPATCH PROCEDURES

M.P. 205.02

10/97-R

Page 1 of 2

The Phoenix Fire Department E.M.S. Dispatch Policy continues to revolve around an adequate, early and pessimistic response of the closest units required to handle a particular medical emergency.

The following medical emergencies will receive a dispatch of the closest fire suppression unit backed up by a paramedic unit. When a four-person paramedic unit is the closest unit, the dispatch of an additional company will be determined by the judgment/experience of the dispatch personnel.

1. Cardiac or respiratory arrest.
2. Near drowning.
3. Chest pain.
4. Difficulty in breathing.
5. Symptomatic high or low blood pressure.
6. Second or third degree burns covering major portions of the body, especially the head and face.
ALL ELECTRICAL BURNS.
7. Serious blunt or any penetrating injuries.
8. Diabetic emergency:
 - a. Insulin shock
 - b. Diabetic coma
9. Overdose or accidental poisoning.
10. Patients with altered levels of consciousness.
11. Cerebral vascular accident (stroke).
12. Imminent or post childbirth, including miscarriages or complications relating to the pregnancy or labor.
13. Shootings.
14. Stabbings.
15. Cuttings/lacerations with significant blood loss.
16. Repeated or extended seizing, first time seizure, febrile seizure.
17. Any severe orthopedic emergency (spinal injuries, pelvic fractures, multiple fractures, etc.).
18. Excessive body temperatures with convulsions or deliriums including heat related disorders (exhaustion or heat stroke).
19. Serious internal medical emergencies, such as:
 - a. Vomiting blood
 - b. Hemorrhaging
20. Possible recent death.
21. Cancer patients (terminal) in distress.
22. Auto accident described as:
 - a. Car/pedestrian
 - b. Car/bicycle
 - c. Motorcycle and/or car/motorcycle
 - d. Serious in nature (car rolled over, person trapped, etc.)

**PHOENIX REGIONAL
STANDARD OPERATING PROCEDURES**

EMS DISPATCH PROCEDURES

M.P. 205.02

10/97-R

Page 2 of 2

23. Any child under 18 months exhibiting any of the above and/or:
- a. Dehydration
 - b. Hypothermia/hyperthermia
 - c. Poor muscle tone
 - d. Failure to feed
22. Any other medical emergency that judgment suggests, based on available information, evaluation by a paramedic is necessary.

All medical emergencies not defined above will receive a dispatch of the nearest fire suppression unit only, to access and treat the patient as well as determine the need for an ALS unit, Rescue or both.

**PHOENIX REGIONAL
STANDARD OPERATING PROCEDURES**

MEDICAL INCIDENT COMMUNICATIONS

M.P. 205.03 10/97-R Page 1 of 2

The Dispatch Center will dispatch an assignment to medical incidents according to the reported scale and severity of the situation. The assignment will be upgraded by Command, as necessary, based on the actual situation encountered.

Dispatch is responsible for notifying and activating other agencies, including hospitals, to provide needed support for management of the incident. The following should be used as guidelines:

2-1 MEDICAL ASSIGNMENT

1. Determine approximate number and triage classification of patients.
2. Contact Level 1 and 2 hospitals when requested by Command. Advise hospitals of situation, location, and number of patients involved. Determine current ability to receive patients.
3. Communicate hospital availability information to Command or Transportation Sector.
4. Advise notified hospitals when incident is terminated if they are not receiving any patients.

1ST ALARM--MEDICAL

1. Determine approximate number and triage classification of patients.
2. Place private medical helicopters and DPS Ranger on stand-by.
3. Contact Level 1 hospitals when requested by Command. Advise hospitals of situation, location, and number of patients involved. Determine current ability to receive patients.
4. Communicate hospital availability to Command or Transportation Sector.
5. Dispatch rescues and helicopters as requested by Command.
6. Advise notified hospitals when incident is terminated if they are not receiving patients.

GREATER ALARM -- MEDICAL

Begin full-scale notification procedure. Continue until reports indicate situation has been stabilized.

NOTIFICATION PROCEDURES FOR MEDICAL DISASTER

This procedure applies to large scale mass casualty medical situations:

A. Rescues

1. Dispatch all available Fire Department rescues to Staging Area. Location shall be designated by Command.
2. Dispatch private ambulance companies as needed.
3. Determine ETA and number of Rescues available.
4. Advise Command of number of Rescues responding.
5. Activate all reserve Fire Department Rescues.

**PHOENIX REGIONAL
STANDARD OPERATING PROCEDURES**

MEDICAL INCIDENT COMMUNICATIONS

M.P. 205.03 10/97-R Page 2 of 2

B. Helicopters

1. Place private medical helicopters and DPS Ranger on stand-by. Determine number and availability to respond.
2. Dispatch as requested by Command.
3. Advise helicopter of radio channel for Landing Zone coordination.

C. Hospitals

1. Advise hospitals and emergency centers of situation, location and approximate number of patients involved. Ask hospitals to determine how many patients they can handle and to stand-by for call back. Advise them not to call the Dispatch Center.
2. Call all Level 1 hospitals and specialty hospitals first. Call Level 2 facilities according to geographic proximity to scene.
3. Call back medical facilities to determine ability to receive patients. Advise Transportation Sector when ready to receive information.
4. Level 1 and 2 medical facilities should be notified according to their specific categories as they relate to the incident (i.e., trauma, burns, pediatric, poisoning, etc.).
5. When Transportation Sector advises that all patients have been transported, confirm number of patients sent to each hospital. Advise each notified hospital of total patients transported or enroute, including those which will not receive any patients. Advise hospitals that no more patients are expected to be transported.

D. City Buses

Ask Command if buses are needed. Dispatch Phoenix Transit buses to the Level 2 staging area.

NOTE: Phoenix Transit buses are radio dispatched.

**PHOENIX REGIONAL
STANDARD OPERATING PROCEDURES**

RESCUE COMMUNICATIONS

M.P. 205.04 03/03-R Page 1 of 6

PURPOSE

The purpose of this procedure is to define the responsibilities of the Dispatch employees in providing Rescues in the fifteen communities within the Phoenix Regional Dispatch jurisdiction.

DEFINITION

A Rescue is a vehicle that transports medical patients to a hospital. The Regional Dispatch Center uses both fire department Rescues and Ambulances owned by private companies. All fire department Rescues are staffed with a minimum of two fire fighters, which are at least EMT certified or EMT-P (paramedics). The private owned ambulances are also staffed with two EMTs or paramedics, however, they are not fire fighters.

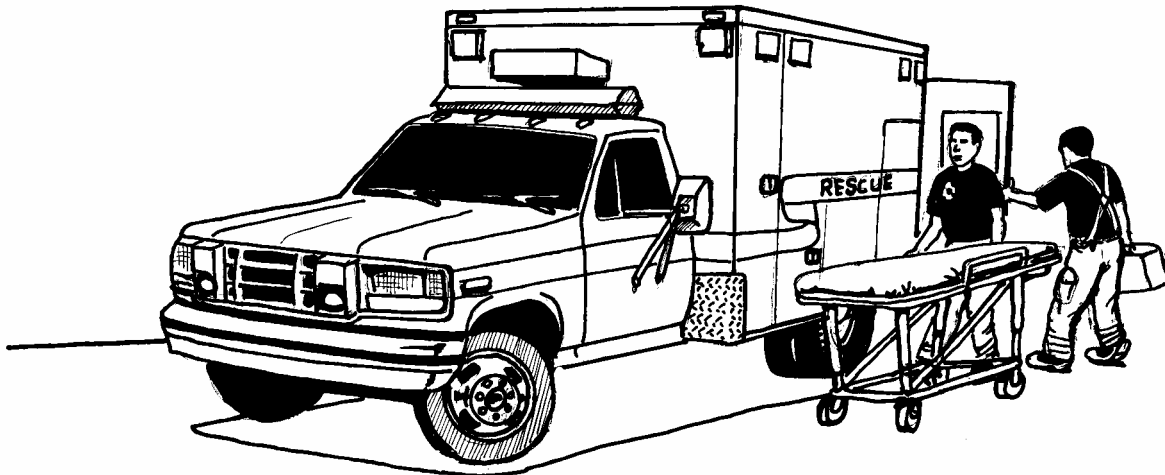

Some of the cities in the dispatch jurisdiction use fire department Rescues and some contract with private companies. Phoenix, Sun Lakes, Sun City West and Daisy Mountain operate fire department Rescues. Glendale, Tempe, Peoria, Sun City, Youngtown, Tolleson, Laveen, Avondale, Guadalupe, El Mirage, and Surprise contract with private companies.

DISPATCH POLICIES

In all cities, except for Phoenix, a Rescue or Ambulance is dispatched on all medical calls, BLS or ALS. In the city of Phoenix, a Rescue is dispatched initially on the following calls: gunshot wound, stabbing, auto accident that appears serious, car/pedestrian accident, code and drowning. A Rescue will be dispatched at the request of a field unit at any time.

**PHOENIX REGIONAL
STANDARD OPERATING PROCEDURES**

RESCUE COMMUNICATIONS

M.P. 205.04 03/03-R Page 2 of 6

Private Transportation Only

A fire department Rescue will be dispatched to transport a patient in stable condition (A stable condition will be defined as: State of health in which the prognosis indicates little, if any, immediate change.) in a "non-emergency" situation ONLY if all private ambulance companies refuse to accept the call for transportation. A fire company and fire department Rescue will respond Code 2 to evaluate and transport the patient.

The Certificate of Need (C.O.N.) prohibits our Rescues from providing service outside of the City of Phoenix. The Phoenix Fire Department is providing the following guidelines to other valley departments when requesting a PFD Rescue.

Requests for emergency transportation must meet the following criteria prior to any response by a Phoenix Rescue:

- First, request to that city current C.O.N. holder
- Second, request to an air transport C.O.N. holder*
- Third, request to Phoenix Fire Department**

*If transport via helicopter is not practical (combative patients, hazardous materials exposures, etc.) or will cause a greater delay in transport of a critically ill or injured person, a Phoenix Fire Department Rescue will respond if requested.

**Patient must be unstable or patient condition would worsen as a result of an extended wait for an ambulance.

These guidelines will insure that when the need for our assistance is critical to patient care a Phoenix Rescue response can be justified.

Calls Received from Private Ambulance Companies

A fire department Rescue will not be dispatched on an emergency call when a private ambulance is responding. If the patient needs "emergency" transportation, the unit on the scene will advise Dispatch to check on the ETA for the private ambulance. If the response time of the private ambulance company is excessive, Dispatch will send a fire department Rescue if the above guidelines have been met and advise the private ambulance company of the situation.

**PHOENIX REGIONAL
STANDARD OPERATING PROCEDURES**

RESCUE COMMUNICATIONS

M.P. 205.04 03/03-R Page 3 of 6

Requests from Governmental Agencies

When a governmental agency (Phoenix Police Department, Arizona DPS, MCSO, etc.) requests a fire department Rescue, Dispatch will determine the nature of the request. If the "emergency" meets the criteria for fire department response, the appropriate assignment will be dispatched with a Rescue. If the request is of a "non-emergency" nature the agency will be routed to the appropriate agency to assist them (i.e., private ambulance company, LARC, taxi, etc.).

Requests from Medical Care Facilities

When a medical care facility (i.e., doctor's office, urgent care center, hospital, etc.) requests a fire department Rescue, Dispatch will determine the nature of the emergency. If the nature of the call is determined to be "non-emergency", the caller will be routed to the appropriate provider (i.e., private ambulance company, helicopter, etc.). If the nature is "emergency," the fire department will respond and transport sick or injured patients from care facilities under the following conditions:

1. An unstable patient necessitating emergency pre-hospital assistance and transfer to the closest hospital.
2. When there are no other transportation options available to a stable patient.

NOTE: If the fire department units respond to a medical care facility and find a patient in a stable condition under the care of a medical professional, all efforts will be made to contact a private provider for transportation instead of a fire department Rescue.

Extended Response Time

When a fire department Rescue is responding to an "emergency" and will have a response time exceeding 20 minutes, the Dispatcher will contact the private ambulance companies and determine if they have a closer unit. If a closer private unit can accept the call, the fire department Rescue will be canceled.

All Fire Department Rescues are Unavailable

If all fire department Rescues are unavailable, Dispatch will contact authorized private ambulance companies to respond on calls with the fire department units. If a fire department Rescue becomes available to respond on the call and is closer to the call than the dispatched private ambulance, the private ambulance will be canceled and the fire department Rescue will respond.

Dispatch will make every effort to send a fire department Rescue to emergencies within the City of Phoenix.

**PHOENIX REGIONAL
STANDARD OPERATING PROCEDURES**

RESCUE COMMUNICATIONS

M.P. 205.04 03/03-R Page 4 of 6

Fire Department Rescue Status

Dispatch will make every effort to monitor Rescue status. It is the responsibility of the Rescue crew to advise Dispatch of any status change.

Rescue at Hospital:

When a Rescue has been at the hospital for approximately 20 minutes, the Channel 1 operator will make contact with them to confirm their status and determine when they expect to go available.

Unavailable Status:

Any time a fire department Rescue goes unavailable an MCT message will be sent to Dispatch in the following format:

TO/DS2 SUPV/ UNAV to (i.e., FUEL, PICK-UP EQUIP, ETC.)

When returning to first due area, Rescues should go available when within 10 minutes driving time to quarters. Units shall monitor Channel 1 traffic while en-route to their first due area for incidents for which they may be the closest response unit.

Returning Paramedic Back to Fire Stations:

The Rescue should NOT go unavailable when returning paramedics back to their fire station.

Rescue Status Conditions

Rescue Status 2 and Status 3 were designed to enhance the emergency transportation service. The Status reflects a shortage of Rescue capability in a specific geographic area or the entire city. During Rescue Status 2 or 3, Rescues should expedite hospital turnarounds and advise Dispatch of anticipated availability.

The Dispatch Captain, Supervisor, and the Channel 1 operator will jointly monitor all Rescue status. When they determine that either a Status 2 or 3 need to be declared, the Channel 1 operator will make the announcement. Each TRO will also make the same announcement on their tactical channels. The Supervisor will fill out the Rescue status form and forward it to ETS.

**PHOENIX REGIONAL
STANDARD OPERATING PROCEDURES**

RESCUE COMMUNICATIONS

M.P. 205.04 03/03-R Page 5 of 6

Rescue Status 2:

Status 2 indicates that there is a Rescue shortage in a particular area of the city. The city is divided into the following areas:

Central	-	I-17 to 24th St, Bethany to I-10
North	-	North of Bethany
South	-	South of I-10
West	-	West of I-17
East	-	East of 24th St.

Rescue Status 3:

Status 3 is an urgent message for ALL Rescues to return to service as quickly as possible. This level of notification shall be treated as a serious situation requiring immediate response. This level is reserved when there are less than three Rescues available in the entire city.

When expediting turnarounds, paperwork should be completed at a later time, over the phone or in person, as the circumstances dictate.

Termination of Rescue Status 3:

Dispatch will announce on Channel 1 and all Tactical channels when Rescue Status 3 is terminated and resume normal operating conditions when additional units are no longer required.

Rescue Use of MCT's

Fire department Rescues will place themselves "responding", "on the scene", "leaving the scene", and "at the hospital" via MCT functions. It is **imperative** that the Rescue attendant checks the MCT for any "NOACK" for these three MCT transmissions. If a "NOACK" appears, use the radio and report "responding", "on the scene", "leaving the scene" and "at the hospital" on the assigned Tactical Radio Channel. The TRO will acknowledge the radio transmission and enter it into the incident history.

Add Unit (AU) to a Medical Incident:

Fire department Rescues should contact the Channel 1 operator and indicate they are available to take a call if they are a closer Rescue. If Dispatch advises the unit to respond, the Rescue must first go available (AOR) from any previous call and add unit (AU) to the new call. Rescues should also utilize the MCT to add unit (AU) when coming out of a hospital to respond to a call. **DO NOT ADD YOURSELF TO THE CALL UNTIL ACTUALLY RESPONDING.**

NOTE: Dispatch will add you to the call if you make a request via radio.

**PHOENIX REGIONAL
STANDARD OPERATING PROCEDURES**

RESCUE COMMUNICATIONS

M.P. 205.04 03/03-R Page 6 of 6

Maximum Number of Rescues Scheduled Out-of-Service:

Only two Rescues will be allowed out-of-service at one time for scheduled activities such as P.M., training, physicals, etc.

Fire department Rescues going out-of-service for preventive maintenance shall contact Dispatch for authorization before placing themselves unavailable. If at all possible, scheduling of Rescue P.M.'s should not occur during the hours of high activity (i.e., 0700 to 0900 and 1500 to 1800).

Part-Time Rescues:

Part-time Rescues ready to go in service at scheduled shift time should contact Dispatch at 262-6595 to indicate they are ready to go in service and use the MCT to place the Rescue Available in Quarters (AIQ).

Part-time Rescues should call the Dispatch Captain/Supervisor at their scheduled off duty time to confirm it is appropriate to take the Rescue out of service. If it is determined necessary to hold them over, the Rescue personnel will be advised at the time to holdover and the approximate time limit of holdover.

At **NO** time should a Rescue go out of service for the shift by using the MCT without checking with Dispatch.

**PHOENIX REGIONAL
STANDARD OPERATING PROCEDURES**

HOSPITAL DIVERSION MANAGEMENT PLAN

M.P. 205.04A

07/99-N

Page 1 of 3

PURPOSE

To establish a process for involved facilities and agencies to effectively manage seasonal emergency department overloads. This procedure supports the Central Region Coordinating System Diversion Protocol.

GOAL

The rapid delivery of definitive medical care through effective management of fire department rescues/ambulance transportation during implementation of regional guidelines on pre-hospital diversion. (Procedure 9701).

DEFINITIONS

Diversion/Bypass are official terms used in AEMS policies to route 911 system patients away from a facility that is saturated or overcrowded to the point that emergency department resources are unavailable. **Critical patients with uncontrollable medical problems will always be triaged to the closest appropriate emergency department.**

- a. **Emergency medical condition** means a medical condition manifesting itself through presentation of acute symptoms with sufficient severity (including severe pain), such that the absence of immediate medical attention could reasonably be expected to result in the following:
 1. Placing the patient's health in serious jeopardy.
 2. Serious impairment of bodily function.
 3. Serious dysfunction of any bodily organ or part.

- b. **Uncontrollable medical problems** shall be defined as those pertaining to the inability to provide an adequate airway or ventilation, lack of a palpable pulse, in the non-traumatic patient.

- c. **Neighboring facilities** shall be defined as emergency departments or trauma services located in proximate geographic areas. This term applies to the cooperative effort of notification of saturation or disaster status and assuring availability of emergency care for patients prior to activation of any pre-hospital diversion.

- d. **Fully committed resources** means the health care professionals at an emergency department or trauma service are at maximum capacity providing treatment to acutely ill or injured patients and are temporarily unable to provide "safe, appropriate, and timely" medical care to patients with an emergency medical condition.

**PHOENIX REGIONAL
STANDARD OPERATING PROCEDURES**

HOSPITAL DIVERSION MANAGEMENT PLAN

M.P. 205.04A

07/99-N

Page 2 of 3

- e. **Informal diversion** shall be defined as a situation during which a pre-hospital care provider or a pre-hospital communication center contacts a facility that has not previously proclaimed a pre-hospital diversion and that care provider or communication center is instructed to divert a patient "or patients" to another facility.

DIVERSION CATEGORIES

The following are **acceptable** pre-hospital diversion categories. The declaration of diversion in one category does not place a facility on diversion in any other category.

- a. **Emergency department saturation:** An emergency department has "fully committed its resources" and is not available for any additional incoming patients with an "emergency medical condition." They shall be listed as "open or closed" by the Dispatch Center.
- b. **Trauma service saturation:** A trauma service has "fully committed its resources" and is not available for additional incoming Level One trauma. A trauma service shall be presented as "open or closed" by the Dispatch Center for those providers.
- c. **Facility internal disaster/equipment failure:** Through policy and procedure established by the internal disaster plan of a hospital, the facility or hospital cannot receive any patients because of a physical plant shutdown (for example, fire, bomb threat, hostage situation, power outage, flood, etc.) or temporary lack of specialty equipment (for example, x-ray, CT scan). If a facility calls for any of the above reasons the Dispatch Center will notify the providers that the facility is "open or closed."

EXCLUSIONS TO PRE-HOSPITAL DIVERSION

- a. At no time will saturation of critical care or medical beds alone be used as a reason to initiate pre-hospital diversion. The critically ill patient must be accepted by the facility, evaluated and stabilized by the emergency department or trauma service or go to surgery.
- b. Pre-hospital patients exhibiting "uncontrollable medical problems" shall be accepted by the closest appropriate facility regardless of hospital status. Critical patients shall be accepted by the closest appropriate hospital when transportation to a more distant hospital will pose a further significant risk to the patient.
- c. Serious, but stable patients may be routed or re-routed by the providers' on-line medical control.
- d. On-line medical control shall remain available at all times from ALS Base hospitals, regardless of their diversion status.

**PHOENIX REGIONAL
STANDARD OPERATING PROCEDURES**

HOSPITAL DIVERSION MANAGEMENT PLAN

M.P. 205.04A

07/99-N

Page 3 of 3

- e. System overload:
 - 1. When the entire system is overloaded (many facilities on diversion), all facilities must open. The EMS system may then be operating in a disaster mode.
 - 2. When many neighboring facilities are on diversion the affected public safety agency(s) may request that a facility or facilities re-evaluate their status and come off diversion, in the interest of public welfare.

PROCEDURE

Emergency department facilities will have the responsibility for notification of the Phoenix Fire Department Dispatch Center of their diversion status. The emergency department charge nurse, paramedic coordinator, or other authorized management will normally make this notification.

Upon notification to the Dispatch Center, the emergency medical dispatcher will assure that the following actions are taken:

- a. Document the time of the call from the facility on the diversion form.
- b. Document the reason for diversion; trauma, ED saturation, or facility internal disaster/equipment failure.
- c. Notify the EMS transportation providers through the CAD, of hospital diversion.
- d. Follow-up with the affected hospital in three hours to reconfirm the status.
- e. The diversion form is routed through the Dispatch Center chief to the EMS office.

**PHOENIX REGIONAL
STANDARD OPERATING PROCEDURES**

FIRE DEPARTMENT RESPONSE TO MCSO JAIL FACILITIES

M.P. 205.05

04/21-N

Page 1 of 4

The Maricopa County Sheriff's Office (MCSO) operates several jail facilities within the City of Phoenix. These jails can pose unique challenges to Fire Companies when responding to, and while operating within, these facilities. These include the loss of radio communications by Fire Department units, securing the inmate population during incidents by Detention staff and when appropriate, the movement of patients by jail and health care staff prior to Fire Department arrival. This document is intended to provide the basis for a standard operating procedure that will enhance firefighter safety and maximize service delivery. It is also important that the Phoenix Fire Department (PFD), the Maricopa County Sheriff's Office (MCSO) and Correctional Health Services (CHS) work in a cooperative and collaborative manner to achieve these goals.

BEFORE THE INCIDENT

- The Fire Department, MCSO and Correctional Health Services shall provide adequate training for their personnel to ensure safe and effective operations.
- Communication systems shall be in place to ensure all agencies have the capability to communicate within jail facilities as well as with resources outside of the jail including Fire Alarm Headquarters (AHQ) during emergency response incidents.
- A process shall be developed to periodically review emergency response, to resolve issues that may arise in a timely manner and produce a findings and recommendations to be delivered to Fire District Commanders and Battalion Chiefs. This would include the establishment of a Problem Resolution Team with representatives from each agency. The Problem Resolution Team shall meet on a quarterly basis and provide an annual report on issues addressed throughout the year with respective Executive Staff.
- High level managers (Deputy Chiefs/Commanders) from each agency shall meet semi-annually in January and July to review report and revise SOP's for PFD response to MCSO jail facilities.

INCIDENT COMMUNICATIONS

- Effective radio communication capability is a requirement for the safety of fire personnel and for the coordination of resources. Fire Department units must always maintain the ability to communicate with AHQ as well as with any resources on scene or responding.
- When communications are lost, the IC must re-evaluate the incident utilizing the PFD risk management policy and adjust accordingly. If the IC is unable to receive accurate and timely information regarding the hazard zone or the safety of the work environment, a change of strategy and the removal of fire personnel from the hazard/work zone may be required.

**PHOENIX REGIONAL
STANDARD OPERATING PROCEDURES**

FIRE DEPARTMENT RESPONSE TO MCSO JAIL FACILITIES

M.P. 205.05

04/21-N

Page 2 of 4

- A Command Officer shall be dispatched to assist with safety concerns, special circumstances or as may be determined by AHQ or the IC on scene.

DISPATCH AND ENROUTE

- AHQ will gather information from the caller that will assist in properly identifying the situation and help to ensure that the appropriate resources are enroute. The information provided should include:
 - Access point
 - Patient condition and location
 - If patient has been moved to a safe/secure area
 - Are inmates secured/confined
- MSCO / CHS Actions
 - Patient will be moved to the CHS clinic area.
 - The goal is to reduce time required for patient contact and expedite treatment and transportation.
 - If a patient cannot be moved, inmates must be secured/controlled so as not to present a safety hazard to Fire personnel.
 - A Battalion Chief, MCSO Lieutenant, and CHS Supervisor shall be notified
 - Adequate force protection will be provided for Fire crews
 - Reliable communications must be established, either by Fire or MCSO or both

ARRIVAL AND ON-SCENE

- Fire Department units will operate within an appropriate risk management plan, perform a thorough scene size-up and maintain a high level of situational awareness.
- Company Officers shall utilize adequate force protection from MCSO when operating inside inmate housing areas.
- Fire Department units will be escorted by a MCSO Corrections Officer with the capability to provide redundant communications via MCSO radio and shall remain with the PFD unit until they exit the interior of the jail facility.
- Fire Department units shall verify with MCSO/CHS that the patient is in a secure area and determine the appropriate zone that they will be working in as defined below:
 - Hot Zone – an area where inmate(s) can readily access and cause harm to fire personnel or crews are without communication capability.

**PHOENIX REGIONAL
STANDARD OPERATING PROCEDURES**

FIRE DEPARTMENT RESPONSE TO MCSO JAIL FACILITIES

M.P. 205.05

04/21-N

Page 3 of 4

- Warm Zone – an area secure from inmate(s) access to fire personnel with reliable communications and where patient treatment / transportation can be initiated (CHS Clinic).
- Cold Zone – an area that is free of threats to fire personnel, typically outside of jail walls and with excellent communication capability.

Note: When operating in a Hot Zone, Fire Department crews shall clearly communicate any identified safety concerns to MCSO prior to entering. MCSO shall address the concerns to make the area safe to operate in. The Company Officer should request a Command Officer to assist with incident management.

PATIENT TREATMENT AND TRANSPORTATION

- Fire Department Responsibilities
 - Emergency services shall be provided as governed by Phoenix Regional SOP's, Emergency Medical Services Directives, and Standing Orders. Patients shall be transported to the closest, most appropriate facility by the safest most appropriate means as determined by the Company Officer / IC and Medical Control.
- MCSO / CHS Responsibilities
 - MSCO is responsible for all jail activities related to inmate management. Correctional Health Services (CHS) is responsible for the administration and management of inmate medical care and services. If the patient is not in the CHS clinic area, every effort should be made to have them moved to this area by MCSO and/or CHS. Fire Department units should only enter inmate cells and inmate holding areas as a last resort.
- Patient Transfer from MSCO / CHS to Fire crews
 - Fire crews should receive a patient with appropriate medical care prior to transfer. A status report will be given and should include patient condition, HPI/MOI, and any treatment and medications given. All patient records should also be included when available.
- Stable / Unstable Patient Transportation
 - As the medical services provider for MCSO jail facilities, CHS should use their established protocol of using a private ambulance service for stable/non-acute patients when possible.
 - If Fire Department units respond to the CHS Clinic and find a patient in stable condition under the care of a medical professional, efforts will be made to contact a private provider for transportation instead of a using Fire Department Rescue.

**PHOENIX REGIONAL
STANDARD OPERATING PROCEDURES**

FIRE DEPARTMENT RESPONSE TO MCSO JAIL FACILITIES

M.P. 205.05

04/21-N

Page 4 of 4

- An unstable patient necessitating emergency pre-hospital care will be transported by Fire Department Rescue to the closest, most appropriate hospital facility. When an inmate is being transported by Fire Department rescue, MCSO will provide an escort officer.

AFTER THE INCIDENT

- At the completion of an incident where the Fire Department responds to a MCSO jail facility, a Jail Facility Encounter Response form shall be completed by the responding crew. This form will be utilized for quality review purposes by the Problem Resolution Team.

PHOENIX REGIONAL
STANDARD OPERATING PROCEDURES

DEPLOYMENT

M.P. 205.05A 10/97-R Page 1 of 2

PURPOSE

This procedure identifies the guidelines and responsibilities when establishing a Deployment Sector.

GUIDELINES

The Planning Section will determine the need to establish a Deployment Sector. Unlike most sectors, this sector will communicate directly with Planning via telephone rather than a tactical radio channel. The Planning Section shall make early contact with the Deployment Sector Officer and establish a phone number for all communications between Planning and Dispatch and Deployment. The Captain in the Dispatch Center will assume the role of Deployment Sector Officer. In the Captain's absence, the Dispatch and Deployment Supervisor will assume this role.

RESPONSIBILITIES

The responsibilities assigned to the Deployment Sector will vary somewhat in each situation depending on type, size and complexity of the incident. The specific responsibilities will include:

- * Maintain adequate Regional coverage throughout the incident.
- * Make emergency notifications to the appropriate Staff personnel and VIP's as requested.
- * Assure the incident is assigned sufficient tactical radio channels.
- * Monitor radio traffic relating to the incident.
- * Assist and support the Supervisor in managing the Dispatch and Deployment Center.
- * Provide and coordinate resources or assistance requested by Command and/or Planning Section.
- * Continually re-evaluate the need for emergency callback of personnel.
- * Assist the Planning Section with a plan for rotating Companies to the scene for relief and overhaul.

The Deployment Sector will be supported by personnel in the Dispatch Center. On multi-alarm incidents, the Dispatch and Deployment Division Chief will respond to the Dispatch Center and at his/her discretion, assume the responsibilities of Deployment Sector Officer.

**PHOENIX REGIONAL
STANDARD OPERATING PROCEDURES**

DEPLOYMENT

M.P. 205.05A 10/97-R Page 2 of 2

Sample Organizational Chart for Dispatch and Deployment during a significant emergency incident:

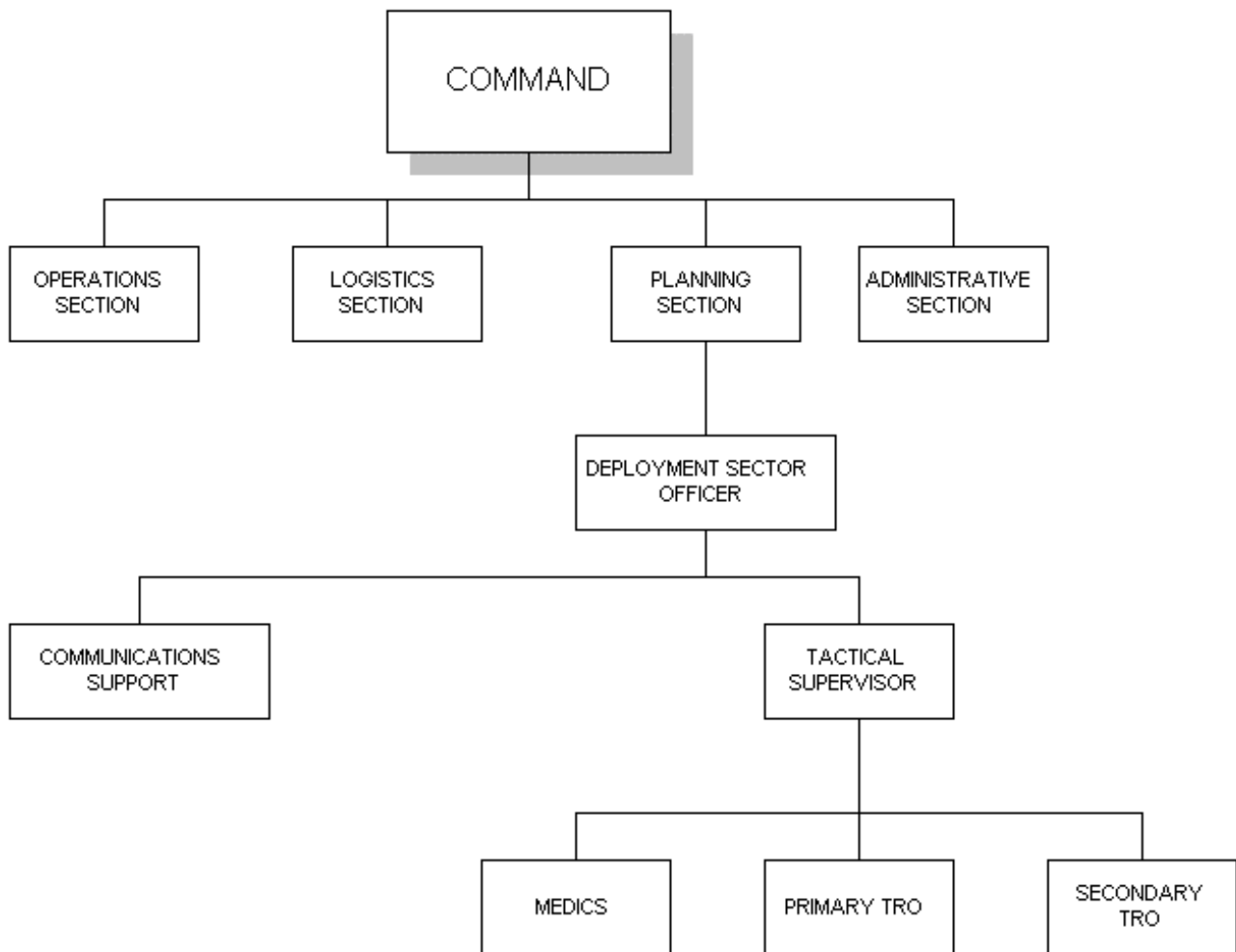

**PHOENIX REGIONAL
STANDARD OPERATING PROCEDURES**

OVERHAUL AND STANDBY ON MAJOR INCIDENTS

M.P. 205.05B

05/95-N

Page 1 of 1

In the aftermath of large-scale fire incidents, the Incident Commander may request fire companies for extended overhaul or standby. The Dispatch Center, in conjunction with the Incident Commander or Planning Section, will determine the following:

- Approximate duration of the overhaul period.
- Number of units needed for each rotation.
- Time interval for rotation of relief units.
- Specific equipment needs.

Taking into consideration the above criteria, the Dispatch Center will develop a plan to deploy companies for the extent of the overhaul period. The rotation plan will be developed using the following criteria:

- Any company that participated for a substantial period of time at the incident should not be placed on the rotation list.
- Companies that have had high levels of activity during the shift should not be placed on the list unless it is absolutely necessary. Unit histories should be checked for the day and companies that have had the least amount of activity should be selected.
- ALS and BLS coverage needs should be evaluated to maintain adequate regional coverage in the response system.
- Multiple units from the same geographic area should not be used.
- When a plan is developed to deploy multiple units for extended overhaul, the companies involved will be notified in advance if possible. Notification will include the time to respond, the duration of their assignment and who their relief will be.
- Time of day and travel distances should be taken into consideration if they are a critical factor.
- When an outlying company is selected for rotation, an adaptive response unit not used on the incident should cover for that company. If an adaptive response unit is not available or does not fall under the above criteria, outlying units should not be used unless absolutely necessary.

Every attempt will be made to adhere to the above criteria in developing the overhaul rotation list. During times of high activity, some exceptions may be made to allow adequate regional coverage at all times. This element of deployment should be a regular component of the selection process in the Dispatch and Deployment Section.

**PHOENIX REGIONAL
STANDARD OPERATING PROCEDURES**

STAGING LEVELS I AND II

M.P. 205.06

03/03-R

Page 1 of 5

Staging--Basic Operational Approach

The objective of Staging procedures is to provide a standard system of initial placement for responding apparatus, personnel, and equipment prior to assignment at tactical incidents.

Effective utilization of these procedures will:

- Prevent excessive apparatus congestion at the scene.
- Allow time for Command to evaluate conditions prior to assigning companies.
- Place apparatus in an uncommitted location close to the immediate scene to facilitate more effective assignment by Command.
- Reduces radio traffic during the critical initial stages of the incident.
- Allow Command to formulate and implement a plan without undue confusion and pressure.
- Provides a resource pool from which Command may assign units and resources at his/her leisure.

Staging involves two levels: LEVEL I and LEVEL II

LEVEL I - STAGING

Level I Staging is automatically in effect for all incidents with three or more companies responding.

During any multi-company response, companies should continue responding to the scene until a company reports on the scene. In situations where the simultaneous arrival of first due companies is possible, the affected officers shall utilize radio communications to coordinate activities and eliminate confusion. It will be the ongoing responsibility of Dispatch to confirm the arrival of the first on-scene unit.

Once a company announces arrival on the scene, Level I Staging will be implemented in the following manner:

For Fires, Hazardous Materials, & Special Operations Incidents

The first arriving engine company will respond directly to the scene and initiate appropriate operations.

The first arriving ladder company will respond directly to the scene. They shall announce their approach to the scene so that Command may commit them to an assignment.

PHOENIX REGIONAL
STANDARD OPERATING PROCEDURES

STAGING LEVELS I AND II

M.P. 205.06

03/03-R

Page 2 of 5

The first chief officer will go directly to the scene and assume Command, all other chief officers should report to Command.

Rescues (full-time/part-time) will stage in direction of travel, uncommitted approximately one block from the scene until assigned by Command. When responding from quarters, Rescues shall wait and allow engine and ladder companies to exit first. In the event a Rescue arrives first on the scene, they will make an on-scene report and assume Command until an engine, ladder, or chief officer arrives and Command is transferred.

All other units will stage in their direction of travel, uncommitted, approximately one block from the scene until assigned by Command. A position providing a maximum of possible tactical options regarding access, direction of travel, water supply, etc., should be selected. At no time should units self-assign.

All utility trucks will assume Level I staging. If Level II staging has been implemented, utility trucks will go to the Level II staging location.

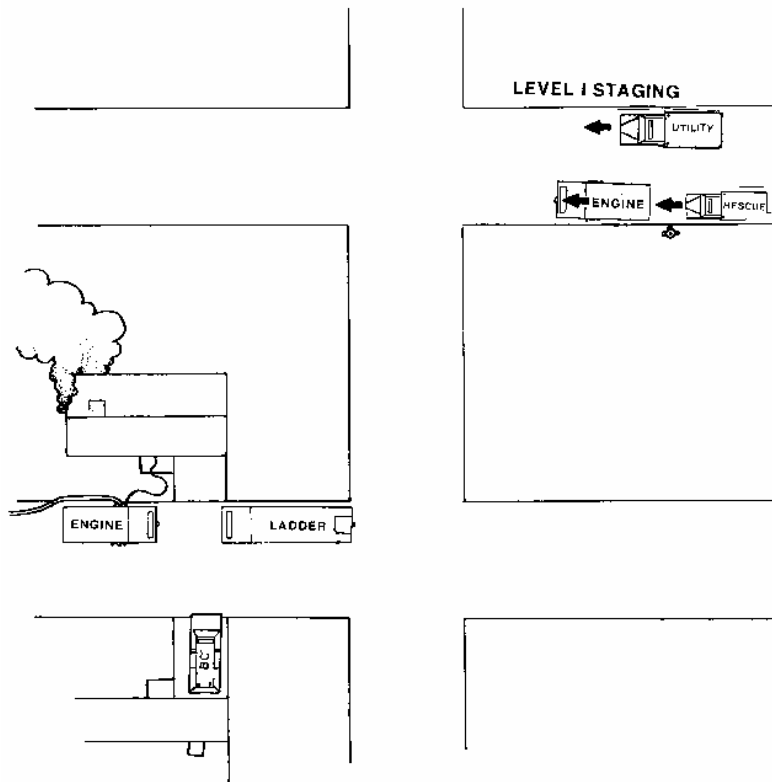

**PHOENIX REGIONAL
STANDARD OPERATING PROCEDURES**

STAGING LEVELS I AND II

M.P. 205.06

03/03-R

Page 3 of 5

For Multi-Company Response to Medical Emergencies

For multi-company response to medical incidents, in addition to the above, the first arriving ALS unit will ALSO go directly to the scene and place their apparatus in a location that will provide maximum access for medical/Rescue support and not impede the movement of other units and indicate their action by radio.

The first arriving Rescue will ALSO go directly to the scene and park their vehicle in a manner that will allow quick and unobstructed exit for patient transportation.

All other companies will stage in their direction of travel, approximately one block from the incident.

Staged companies or units will announce their arrival and report their company designation and their staged location/direction ("Engine One, South").

An acknowledgment is not necessary from either the Dispatch Center or Command. Staged companies will stay off the air until orders are received from Command. If it becomes apparent Command has forgotten the company is in a staged position, the company officer shall contact Command and advise him/her of their staged status.

These staging procedures attempt to reduce unnecessary radio traffic, but in no way should reduce effective communications or the initiative of officers to communicate. If staged companies observe critical tactical needs, they will advise Command of such critical conditions and their actions.

LEVEL II - STAGING

Level II Staging is utilized when Command desires to maintain a reserve of resources on-scene, and when the need to centralize resources is required. Level II Staging places all reserve resources in a central location and automatically requires the implementation of a Staging Sector Officer.

Level II Staging will be implemented for all greater alarm incidents. Level II staging should be considered for first alarm medical or hazardous materials incidents, or other incidents in which Command desires to centralize resources, or simply to park apparatus in a central, unobstructed location.

Companies which are already staged (Level I) or en-route to Level I Staging, will stay in Level I unless otherwise directed by Command. All other responding units will proceed to the Level II Staging Area. When activating Level II Staging, Command will give an approximate location for the Staging Area and request a separate radio channel for the Staging Sector.

PHOENIX REGIONAL
STANDARD OPERATING PROCEDURES

STAGING LEVELS I AND II

M.P. 205.06

03/03-R

Page 4 of 5

The Staging Area should be some distance away from the Command Post and the emergency scene to reduce site congestion, but close enough for prompt response to the incident site.

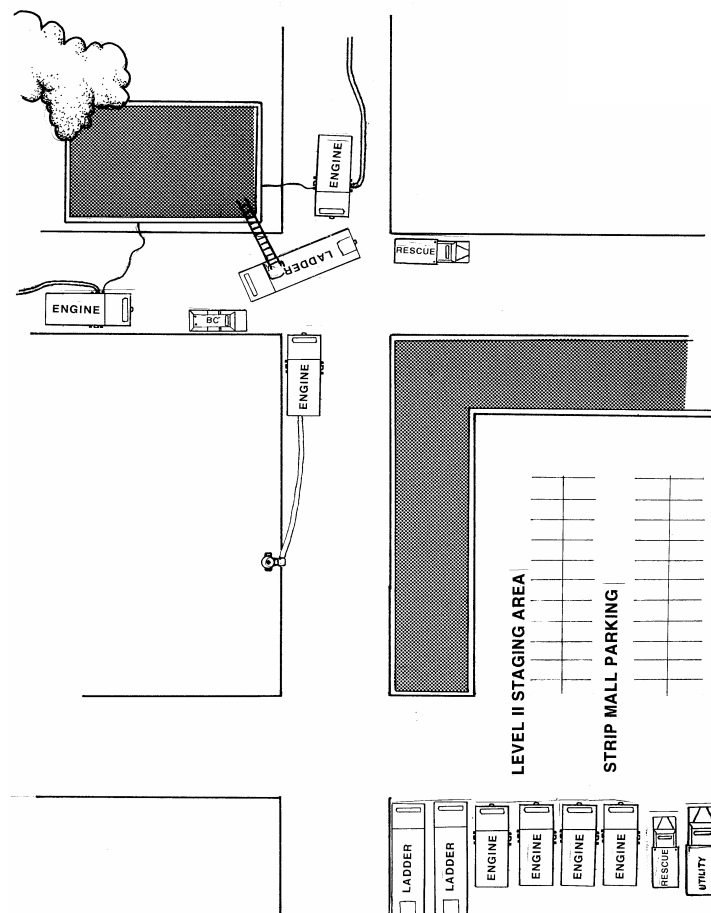

Command should consider Level II Staging when calling for additional resources and request a separate radio channel. This is more functional than calling for Level II Staging while units are en-route. The additional units will be dispatched to the Staging Area. Responding units should monitor both the tactical and staging channels.

Command may designate a Staging Area and Staging Officer who will be responsible for the activities outlined in this procedure. In the absence of such an assignment, the first fire department officer to arrive at the Staging Area will automatically become the Staging Officer and will notify Command on arrival. The arrival notification will be made to Command on the assigned tactical channel.

**PHOENIX REGIONAL
STANDARD OPERATING PROCEDURES**

STAGING LEVELS I AND II

M.P. 205.06

03/03-R

Page 5 of 5

Due to the limited number of ladder companies, a ladder officer will transfer responsibility for Staging to the first arriving engine company officer. Staging Officers will assign their company members as needed to assist with Staging operations, or assign them to another company.

All responding companies will stay off the air, respond directly to the designated Staging Area, and the Company Officer will report in person to the Staging Officer. The crew will standby their unit with crew intact and warning lights turned off until assigned incident site duties, or released from the scene.

When assigned to on-site duties, companies leaving staging will communicate directly with Command or their assigned sector officer for instructions.

Once Level II staging is implemented, all communications involving staging will be between Staging and Command or Logistics.

STAFF CHIEF OFFICERS AND CAPTAINS

Arrival on the scene of staff Chief Officers and Captains can enhance the Command organization and incident management. Unless arriving staff officers have predetermined responsibilities (i.e., Safety Sector, Haz Mat Sector), these officers should assume a Level I staging posture and announce their arrival on the tactical channel. If the Staging Sector has been assigned a separate radio channel, notification should be on the designated channel.

Vehicle parking at the site can be limited. Staff officers should leave their vehicles in the Staging Sector, or park well off the road (i.e., parking lots) so as not to restrict on-site access by fire apparatus.

**PHOENIX REGIONAL
STANDARD OPERATING PROCEDURES**

STAGING SECTOR

M.P. 205.06A

03/03-R

Page 1 of 2

This procedure defines the responsibilities of the Staging Sector Officer. Level II staging is implemented by Command and should be utilized for all greater alarm incidents, first alarm medical or hazardous materials incidents, or other incidents in which Command desires to centralize resources, or simply park apparatus in a central, unobstructed location.

Level II staging will require all responding companies to report to the central staging location.

Implementation of Level II staging automatically requires the implementation of a "Staging Sector" Officer. Command should request a separate radio channel and may designate a Staging Sector Officer. Where an officer is not designated, the first company to arrive at the designated staging location will automatically become the staging officer.

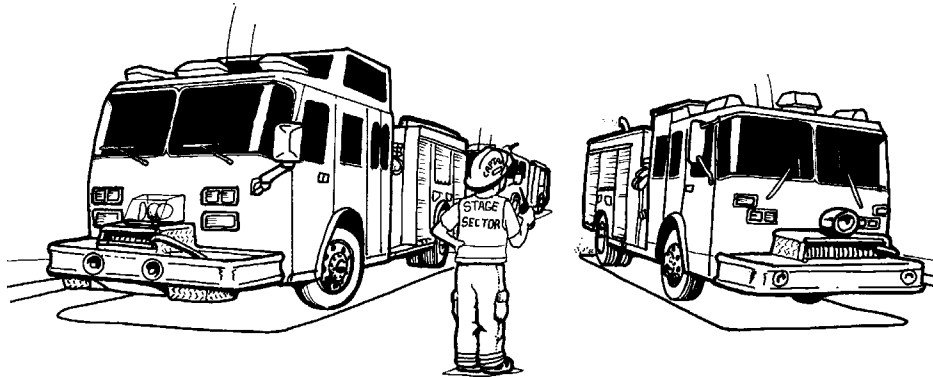

Where the first company to staging is a ladder company, Staging Sector responsibilities should be transferred to an engine company officer upon his arrival on the scene.

Radio designation will be "Staging Sector."

Command will request a separate radio channel to be used for Command Post to Staging Sector communications and advise the Staging Sector Officer.

The staging area should be outside the incident site perimeter, but close enough for quick response to the scene. The staging area should allow staged companies to access any geographic point of the incident without delay or vehicle congestion.

**PHOENIX REGIONAL
STANDARD OPERATING PROCEDURES**

STAGING SECTOR

M.P. 205.06A

03/03-R

Page 2 of 2

The staging officer will also be responsible for the following functions:

1. Locate an area of adequate size for all apparatus, including apparatus that may respond with additional alarms.
2. Transmit the staging area location to Command and Dispatch, indicating access and routing as needed.
3. Coordinate with the Police Department to block streets, intersections, and other access required for the staging area.
4. Ensure that all apparatus is parked in an appropriate manner for quick exit.
5. Maintain a log of companies available in the staging area and inventory all specialized equipment that might be required at the scene.
6. Maintain crews in a ready state with their apparatus.
7. Provide progress reports to Command indicating number and type of units available.
8. Assume a position that is visible and accessible to incoming and staged companies. This will be accomplished by leaving the red lights operating on the staging officers apparatus and by wearing a sector vest.
9. Assign staged companies to incident duty per Command's direction.

When directed by Command, the Staging Officer will verbally assign companies to report to specific sectors, telling them where and to whom to report. Staging will then advise Command of the specific unit assigned. Command will advise each sector officer the companies being assigned to the sector. The receiving Sector Officer may then communicate directly with the company by radio.

When assigned to incident site duties, companies will activate their MCT "on-scene" button.

The Staging Sector Officer will give Command periodic reports of available companies in staging. Command will utilize this information to request additional resource as needed.

The Staging Sector Officer should organize staging in a manner that will allow apparatus to effectively move into and out of staging. Adequate space between apparatus is required. Ladders companies should be placed in one area, engines in another, and rescues in another area.

Where only staff or specialized equipment is needed at the scene, staging should arrange a "taxi" service using a single company to deliver multiple crews or specialized equipment to the scene. This will minimize site congestion.

During major incidents where a "Logistics" Section is implemented, the Staging Sector will be working under the direction of the Logistics Officer.

**PHOENIX REGIONAL
STANDARD OPERATING PROCEDURES**

APPARATUS PLACEMENT

M.P. 205.07

01/95-R

Page 1 of 3

Apparatus function should regulate placement. Poor apparatus placement can reverse this rule, limiting the options or eliminating functions we can assign to a unit.

Fire fighters operate with a natural inclination to drive apparatus as close to the fire as possible. This often results in positioning of apparatus that is both dysfunctional and dangerous. The placement of all apparatus on the fireground should be a reflection of the following:

- Standard operational procedure for first arriving companies.
- Tactical objectives and priorities.
- Staging procedure.
- A direct order from Command.
- A conscious decision on the part of the Company officer based on existing or predictable conditions.

Effective apparatus placement must begin with the arrival of first units. The placement of the initial arriving engine, ladder, and Rescue should be based upon initial size-up and general conditions upon arrival. First arriving companies should place themselves to maximum advantage and go to work; later arriving units should be placed in a manner that builds on the initial plan and allows for expansion of the operation.

Avoid "belly to butt" placement on the fireground. Do not drive all fire apparatus directly to the fire. Later arriving companies should stage a minimum of one block short of the immediate fire area, and remain uncommitted until ordered into action by Command. Company officers should select staged positions with a maximum of tactical options (See Level I Staging procedures).

In large, complex, and lengthy fireground operations additional alarm companies should be staged consistent with Level II Staging procedure. Under these procedures, Command communicates directly with the Staging Officer for the additional resource required on the fireground.

Command must maintain an awareness of site access that provides tactical options and that the immediate fire area can quickly become congested with apparatus. The officer must regard apparatus on the fireground in two categories:

- Apparatus that is working
- Apparatus that is parked

Park out of the way. Apparatus that is not working should be left in the Staging Area or parked where it will not compromise access.

Maintain an access lane down the center of streets wherever possible.

Think of fire apparatus as an expensive exposure: position working apparatus in a manner that considers the extent and location of the fire and a pessimistic evaluation of fire spread and building

failure. Anticipate the heat which may be released with structural collapse. Forecast where the fire is going and how it will affect exposure of apparatus. Apparatus should generally be positioned at least

**PHOENIX REGIONAL
STANDARD OPERATING PROCEDURES**

APPARATUS PLACEMENT

M.P. 205.07

01/95-R

Page 2 of 3

30 ft. away from involved buildings, even with nothing showing. Greater distances are indicated in many situations.

Beware of putting fire apparatus in places where it cannot be repositioned easily and quickly--particularly operating positions with only one way in and out; i.e., yards, alleys, driveways, etc.

Beware of overhead power lines when positioning apparatus. Do not park where lines may fall.

If apparatus does become endangered, activate engine sprinkler system and operate hoselines between it and the fire while you reposition it. When you do move it--move it to a position that is safe. It is dysfunctional to move apparatus several times throughout the progress of a fire.

Take maximum advantage of good operating positions and "build" the capability of units assigned to these effective positions. Initial arriving pumpers should be placed in "key" positions. These positions should offer maximum fire attack access to the fire area and be supplied with large diameter pumped supply lines as quickly as possible. Subsequent arriving companies can operate the hoselines from this apparatus. Place these "key" companies first--before access is blocked by later arriving units.

Key tactical positions should be identified and engines placed in those locations with a strong water supply. The water supply should be at least one pumped line from an engine on a hydrant. When high volume is indicated, two pumped supply lines should be provided. The forward engine can distribute this water supply to a variety of hand lines, master streams or devices.

Take full advantage of hydrants close to the fire before laying additional supply lines to distant hydrants. Secondary hydrants should be used to obtain additional supply if the demand exceeds the capability of the closest hydrants.

Take advantage of the equipment on apparatus already in the fire area instead of bringing in more apparatus. Connect extra lines to pumpers which already have a good supply line instead of making "daisy chain" supply line connections.

Do not hook up to hydrants so close to the fire building that structural failure or fire extension will jeopardize the apparatus.

Fire hose soon limits the general access as the fireground operation gets older. Command and Sectors must direct apparatus to important positions as early as possible. Lines should be laid with attention to the access problems they present. Try to lay lines on the same side of street as the hydrant and cross over near the fire.

When the aerial apparatus is not needed for upper level access or Rescue, spot apparatus in a position that would provide an effective position for elevated stream operation if the fire goes to a defensive mode. Ladder officers must consider extent and location of fire, most dangerous direction of spread, confinement, exposure conditions, overhead obstructions and structural conditions in spotting apparatus. The truck should be spotted where the aerial can be raised and used effectively without repositioning. It must also be spotted for effective use of hand ladders and allied forcible entry equipment.

**PHOENIX REGIONAL
STANDARD OPERATING PROCEDURES**

APPARATUS PLACEMENT

M.P. 205.07

01/95-R

Page 3 of 3

Command vehicles should be positioned at a location that will allow maximum visibility of the fire building and surrounding area and the general effect of the companies operating on the fire. Command vehicle position should be easy and logical to find and should not restrict the movement of other apparatus.

Rescue units should be spotted in a safe position that will provide the most effective treatment and transportation of fire victims and fire fighting personnel, while not blocking movement of other apparatus or interfering with fire fighting operations. Staff vehicle placement should go to Level II staging unless that staff person has a pre-designated responsibility (i.e., Safety Sector). The staging sector officer will advise Command of staff personnel available for assignment.

**PHOENIX REGIONAL
STANDARD OPERATING PROCEDURES**

Safe Parking While Operating in or Near Vehicle Traffic

M.P. 205.07A

04/18

Page 1 of 6

Purpose

This procedure identifies parking practices for Fire Department apparatus that will provide maximum protection and safety for personnel operating in or near moving vehicle traffic. It also identifies several approaches for individual practices to keep firefighters safe while exposed to vehicle traffic.

It shall be the policy of the Regional Fire Department to position apparatus at the scene of emergencies in a manner that best protects the work area and personnel from vehicle traffic and other hazards.

All personnel should understand and appreciate the high risk that firefighters are exposed to when operating in or near moving vehicle traffic. We should always operate from a defensive posture. Always consider moving vehicles as a threat to your safety. Each day, emergency personnel are exposed to motorists of varying abilities, with or without licenses, with or without legal restrictions, and driving at speeds from creeping to well beyond the speed limit. Some of these motorists could be the vision impaired, or alcohol and/or drug impaired. On top of everything else, motorists will often be looking at the scene and not the road.

Nighttime operations are particularly hazardous. Visibility is reduced, and the flashing of emergency lights tend to confuse motorists. Studies have shown that multiple headlights of emergency apparatus (coming from different angles at the scene) tend to blind drivers as they approach.

Safety Benchmarks

Emergency personnel are at great risk while operating in or around moving traffic. There are approaches that can be taken to protect yourself and all crewmembers:

- Never trust the traffic
- Engage in proper protective parking
- Always wear high visibility reflective vests
- Reduce motorist vision impairment
- Use traffic cones and flares

Listed below are benchmarks for safe performance when operating in or near moving vehicle traffic.

- Always maintain an acute awareness of the high risk of working in or around moving traffic. Never trust moving traffic. Always look before you step! Always keep an eye on the traffic!

**PHOENIX REGIONAL
STANDARD OPERATING PROCEDURES**

Safe Parking While Operating in or Near Vehicle Traffic

M.P. 205.07A

04/18

Page 2 of 6

- Always position apparatus to protect the scene, patients, emergency personnel, and provide a protected work area. Where possible, angle apparatus at 45 degrees away from curbside. This will direct motorist around the scene (See Figure 1). Apparatus positioning must also allow for adequate parking space for other fire apparatus (if needed), and a safe work area for emergency personnel. Allow enough distance to prevent a moving vehicle from knocking fire apparatus into the work areas.
- At intersections, or where the incident may be near the middle of the street, two or more sides of the incident may need to be protected. Block all exposed sides. Where apparatus is in limited numbers, prioritize the blocking from the most critical to the least critical (See Figures 2, 3 and 4).
- For first arriving engine companies, where a charged hoseline may be needed, angle the engine so that the pump panel is "downstream," on the opposite side of on-coming traffic. This will protect the pump operator (See Figure 5).
- The initial company officer (or Command) must assess the parking needs of later-arriving fire apparatus and specifically direct the parking and placement of these vehicles as they arrive to provide protective blocking of the scene. This officer must operate as an initial safety officer.
- During daytime operations, leave all emergency lights on to provide warning to drivers.
- For NIGHTTIME operations, turn OFF fire apparatus headlights. This will help reduce the blinding effect to approaching vehicle traffic. Other emergency lighting should be reduced to yellow lights and emergency flashers where possible.
- Crews should exit the curb side or non-traffic side of the vehicle whenever possible.
- Always look before stepping out of apparatus, or into any traffic areas. When walking around fire apparatus parked adjacent to moving traffic, keep an eye on traffic and walk as close to fire apparatus as possible.
- Always wear a safety vest any time you are operating in or near vehicle traffic.
- When parking apparatus to protect the scene, be sure to protect the work area also. The area must be protected so that patients can be extricated, treated, moved about the scene and loaded into Rescues safely.
- Once enough fire apparatus have "blocked" the scene, park or stage unneeded vehicles off the street whenever possible. Bring in Rescue/Ambulance companies one or two at a time and park them in safe locations at the scene. This may be "downstream" from other parked apparatus, or the Rescue may be backed at an angle into a protected loading area to prevent working in or near passing traffic.
- At residential medical emergencies, park Rescue in driveways for safe loading where possible. If driveways are inaccessible, park Rescue to best protect patient loading areas. (See Figures 6 and 7).
- Place traffic cones at the scene to direct traffic. This should be initiated by the first company arriving on the scene and expanded, if needed, as later arriving companies arrive on the scene. Always place and retrieve cones while facing on-coming traffic.

**PHOENIX REGIONAL
STANDARD OPERATING PROCEDURES**

Safe Parking While Operating in or Near Vehicle Traffic

M.P. 205.07A

04/18

Page 3 of 6

- Placing flares, where safe to do so, adjacent to and in combination with traffic cones for nighttime operations greatly enhances scene safety. Place flares to direct traffic where safe and appropriate to do so. Listed below are general recommendations for the start of traffic cones/flares:

<u>Speed</u>	<u>Distance</u>
25 mph	65 feet
40 mph	105 feet
60 mph	160 feet

- At major intersections, a call for police response may be necessary. Provide specific direction to the police officer as to exactly what your traffic control needs are. Ensure the police are parking to protect themselves and the scene. Position Rescues to protect patient loading areas. (See Figure 8)

Freeway Operations

Freeway emergencies pose a particularly high risk to emergency personnel. Speeds are higher, traffic volume is significant, and motorists have little opportunity to slow, stop or change lanes. The Department of Public Safety will also have a desire to keep the freeway traffic flowing. Where need be, the freeway can be completely shut down. This, however, rarely occurs.

For freeway emergencies, we will continue to block the scene with the first apparatus on the scene to provide a safe work area. Other companies may be used to provide additional protection if needed. The initial company officer, or command, must thoroughly assess the need for apparatus on the freeway and their specific positions. Companies should be directed to specific parking locations to protect the work area, patients and emergency personnel. Other apparatus should be parked downstream when possible. This provides a safe parking area.

Staging of Rescue companies off the freeway may be required. Rescues should be brought into the scene one or two at a time. A safe loading area must be established.

Traffic cones should be placed farther apart, with the last cone approximately 160 feet "upstream," to allow adequate warning to drivers. Place and retrieve cones while facing the traffic.

Command should establish a liaison with the Department of Public Safety as soon as possible to jointly provide a safe parking and work area and to quickly resolve the incident. The termination of the incident must be managed with the same aggressiveness as initial actions.

PHOENIX REGIONAL
STANDARD OPERATING PROCEDURES

Safe Parking While Operating in or Near Vehicle Traffic

M.P. 205.07A

04/18

Page 4 of 6

Crews, apparatus, and equipment must be removed from the freeway promptly to reduce exposure to moving traffic.

Figure #1

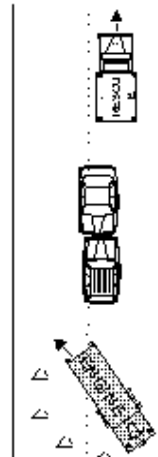

Where possible, angle apparatus at a 45 degree angle from the curb.

Figure #3

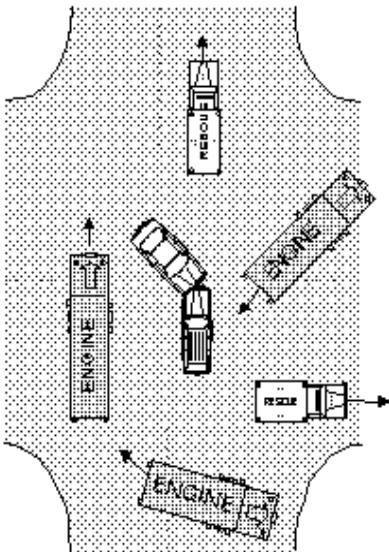

Figure #2

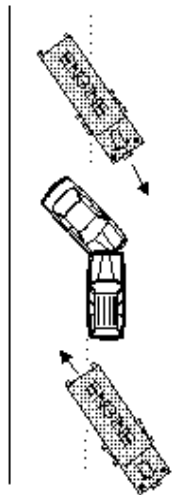
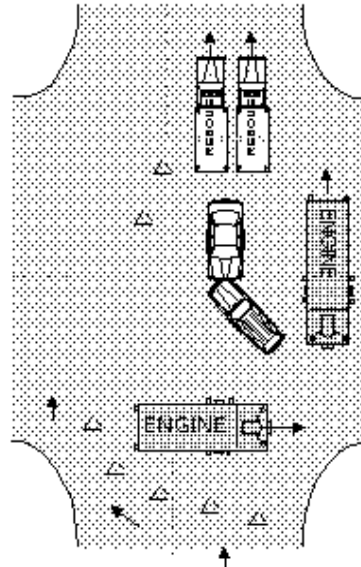

Figure #4



Often times two or more sides may need to be protected. Prioritize placement of the apparatus by blocking from the most critical to the least critical side.

PHOENIX REGIONAL
STANDARD OPERATING PROCEDURES

Safe Parking While Operating in or Near Vehicle Traffic

M.P. 205.07A

04/18

Page 5 of 6

Figure #5

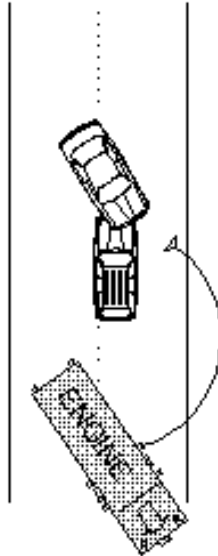

To protect pump operator, position apparatus with the pump panel on the opposite side of on-coming traffic.

Figure #6

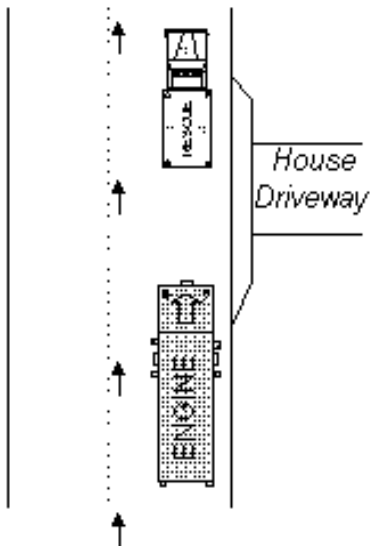
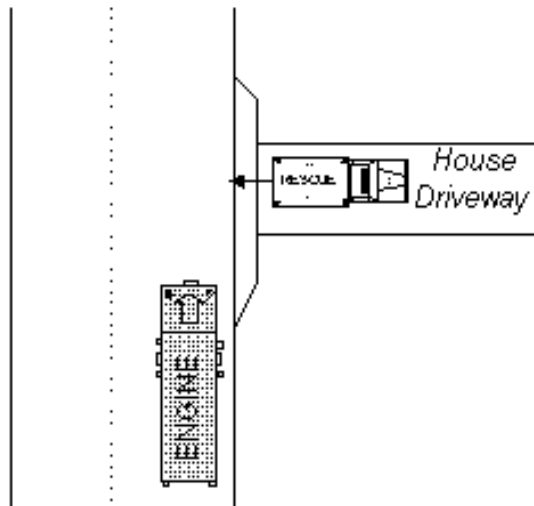

Figure #7



Where possible, park rescues in driveways or position rescue to protect patient loading area.

PHOENIX REGIONAL
STANDARD OPERATING PROCEDURES

Safe Parking While Operating in or Near Vehicle Traffic

M.P. 205.07A

04/18

Page 6 of 6

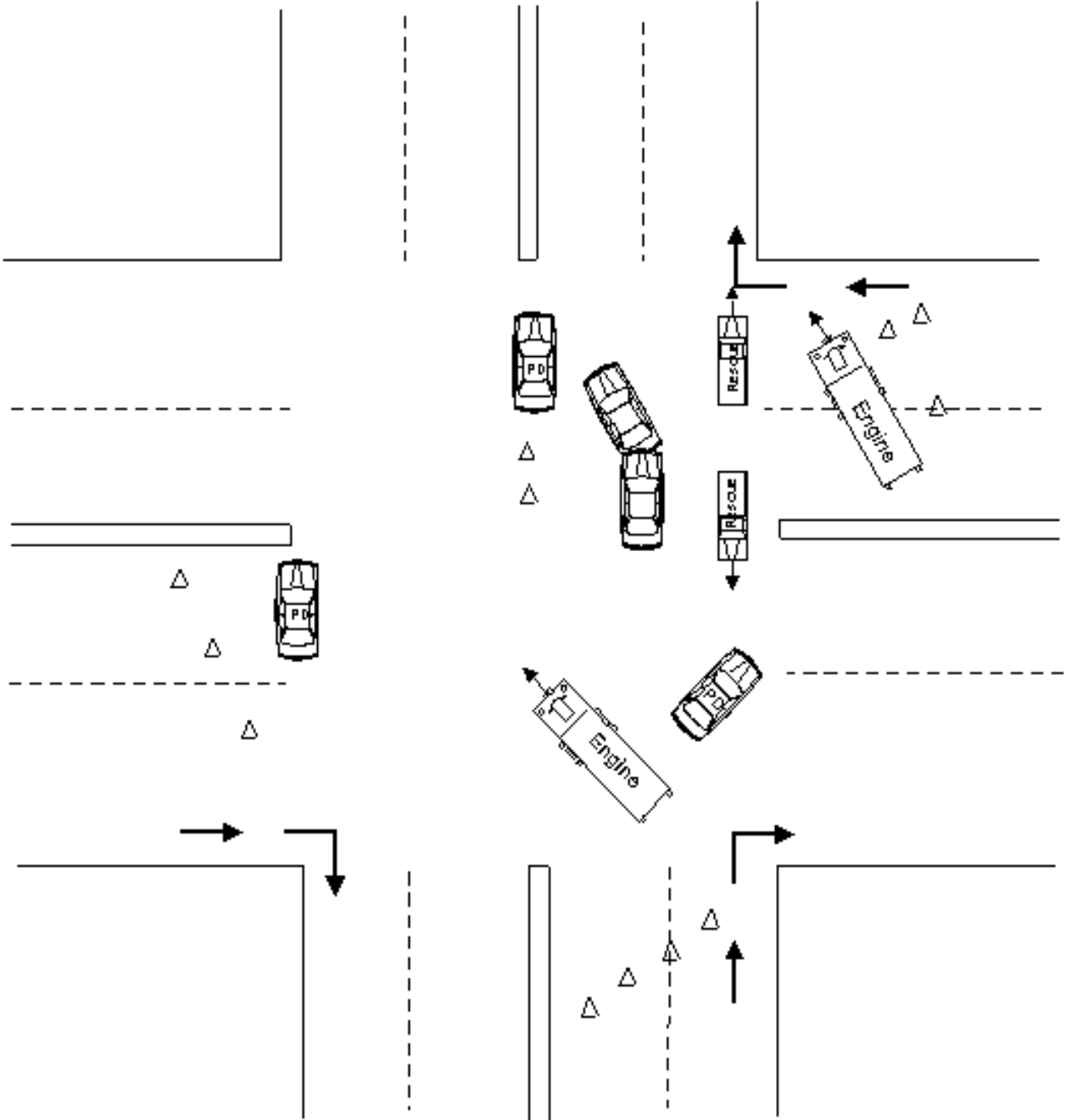

Provide specific direction to police as to what traffic control needs you have. Position rescues to protect patient loading areas.

PHOENIX REGIONAL STANDARD OPERATING PROCEDURES	
Policy Name: DRIVER SAFETY	Policy Number: M.P. 205.08
This policy is for internal use only and does not expand an employee's legal duty or civil liability in any way. This policy should not be construed as creating a duty to act or a higher duty of care, with respect to third party civil claims against employees or the Phoenix Fire Department (PFD). Remedies for violations of this policy, if proven, are limited to administrative disciplinary action against PFD employees.	
Related Policies: M.P. 205.08A	
Other Reference: A.R.S 28-624	
Date Implemented: 12/2021-R	Review Date: 12/2026

PURPOSE

This procedure identifies the minimum standards for the operation and supervision of emergency vehicle movement and safety.

ARIZONA MOTOR VEHICLE CODE AND SAFETY

It is the responsibility of the driver of each Fire Department vehicle to drive safe, in a reasonable and prudent manner at all times. Vehicles shall be operated in compliance with the Arizona Motor Vehicle Code. This code provides specific legal exceptions to regular traffic regulations, which apply to properly equipped and authorized Fire Department vehicles only when responding to an emergency incident or when transporting a patient to a medical facility. Emergency response (Code 3) does not absolve the driver of the responsibility to drive with due caution and reasonable care. The driver of the emergency vehicle is responsible for its safe operation at all times. This responsibility includes but is not limited to the following:

1. All City of Phoenix employees are required to wear seat belts at all times when operating a City vehicle.
2. Anyone riding as a passenger/attendant in a City vehicle is also required to wear seat belts (e.g., Rescue, Engine, Ladder, Utility, Squad, Staff Vehicle, etc.). The Driver and/or Company Officer of the vehicle will confirm that all personnel and riders are on-board, properly attired, with seat belts on, before the vehicle is permitted to move.
3. Drivers shall avoid backing whenever possible. Where backing is unavoidable, spotters shall always be used. If no spotter is available, the driver shall dismount and walk completely around the apparatus to determine if obstructions are present before backing (Refer to M.P. 205.08A Standard Signals for Backing of Fire Department Apparatus).
4. All personnel shall ride only in regular seats provided with seat belts. Riding on tailboards or in other exposed positions is not permitted on any vehicle at any time.

5. The unique hazards of driving on or adjacent to the fire ground require the driver to use extreme caution and to be alert and prepared to react to the unexpected.
6. Drivers must consider the dangers their moving vehicle poses to fire ground personnel and spectators who may be preoccupied with the emergency and may inadvertently step in front of or behind a moving vehicle.

EMERGENCY RESPONSE POLICY

Phoenix Fire Department vehicles shall be operated in a manner that provides for the safety of all persons and property. Prompt, safe response shall be attained by:

1. Leaving the station in a standard professional manner;
2. Quickly mounting apparatus;
3. All personnel on board, seated with seat belts on;
4. Station apparatus bay doors open fully;
5. Driving defensively and professionally at reasonable speeds;
6. Knowing where we are going (i.e., your destination and routing), effectively managing multiple other tasks (e.g., Mobile Computer Terminal monitoring, alarm room updates, road closers, staging locations, hydrant locations, etc.); and
7. Using warning devices to move around traffic and to request the right-of-way in a safe and predictable manner.

Fast response shall not be attained by:

1. Leaving quarters before crew has mounted safely and before apparatus bay doors are fully open.
2. Driving too fast for conditions.
3. Driving recklessly or without regard for safety.
4. Taking unnecessary chances with negative right-of-way intersections.

CODE 3 EMERGENCY RESPONSE STANDARDS

The following rules govern emergency response:

1. Maximum of 10 mph over posted speed limit.
2. Recognizing there will be a brief deceleration period, maximum of 20 mph when traveling in center or oncoming traffic lanes.
3. When traveling in center or oncoming traffic lanes, complete stop at all stop signs and traffic lights regardless of the color of the light.
4. When traveling with traffic, complete stop at all red lights, and stop signs.

RESPONSE ACKNOWLEDGMENT

Response codes will be displayed on the Mobile Computer Terminal (MCT). If no response code is designated, the response will be Code 2 unless directed by a Company Officer. Officers and Rescue Attendants must press the correlating response code button on the MCT or through notification to the Alarm Room on the appropriate tactical radio channel.

Response codes for all emergency response vehicles will be determined by the Company Officer based on information received from the Alarm Room, time of day, traffic conditions, weather conditions, and other factors.

Rescue units will respond as directed by deployment policy; they do not have the authority to upgrade their response to Code 3 unless directed by the responding or on scene Company Officer. When a Rescue is the "first due" unit on a BLS incident they will respond as directed by the Alarm Room or the responding Company Officer. Rescue crews should keep the responding Company Officer apprised (by radio) of excessive time delays or other conditions that may warrant an upgrade to Code 3.

CODE 3 DRIVER AND CO-DRIVER RESPONSIBILITIES

Fire Department emergency response vehicles shall have 2 PFD members in the front seats of the vehicle whenever possible while responding Code 3. In addition to supervisory responsibilities, Company Officers or ranking Officers in the front seats have Co-driver responsibilities.

1. The Driver is responsible for operating the vehicle safely and compliance with this policy.
2. The Co-driver is responsible for being a second set of eyes and ears anytime a unit is responding Code 3.
3. Driver and Co-driver must be focused on intersection management any time a PFD vehicle enters an intersection Code 3.
4. Intersection management requires the Drivers and Co-driver's undivided attention.
5. The Co-driver and the Driver should be accounting for clearance in all traffic lanes including pedestrian traffic.
6. Where a complete stop is required by policy, the Co-driver shall announce if it is clear or not clear to proceed. The Driver makes the final decision of when it is clear to proceed.

Note: The Company Officer or ranking Officer is responsible for safety and policy compliance.

CODE 3 DRIVING POLICY

Fire Department Drivers and Co-drivers will comply with the following while operating vehicles Code 3:

1. When responding Code 3, warning lights must be on and sirens must be sounded to warn drivers of other vehicles, as required by the Arizona Motor Vehicle Code.
 - a. The use of sirens and warning lights does not automatically give the right-of-way to the emergency vehicle. These devices simply request the right-of-way from other drivers, based on their awareness of the emergency vehicle.
 - b. Emergency vehicle drivers must make every possible effort to make their presence and intended actions known to other drivers and must drive defensively to be prepared for the unexpected inappropriate actions of others.

2. Fire Department vehicles are authorized to exceed posted speed limits only when responding Code 3 under favorable conditions. Under these conditions a maximum of 10 mph over the posted speed limit is authorized.
 - a. Recognizing there will be a brief deceleration period, when an emergency vehicle must travel in center or oncoming traffic lanes, the maximum permissible speed shall be 20 mph.
 - b. When an emergency vehicle must use center or oncoming traffic lanes to approach-controlled intersections (traffic light or stop sign), the vehicle must come to a complete stop before proceeding through the intersection, including occasions when the vehicle has a green traffic light.
 - c. When an emergency vehicle approaches a negative right-of-way intersection (red light or stop sign), the vehicle shall come to a complete stop and may proceed only when the Driver can account for all oncoming traffic in all lanes yielding the right-of-way.
3. Code 3 response is authorized only in conjunction with emergency incidents. Unnecessary emergency response shall be avoided. To avoid any unnecessary emergency response, on multi-company responses, the first arriving unit (Incident Commander) will advise additional units to respond Code 2 when appropriate.
4. During an emergency response, fire vehicles should avoid passing other emergency vehicles. If passing is necessary, permission must be obtained through radio communications, using the communications order model.
5. Water Tenders are not permitted to respond Code III.

ALS AND BLS EMERGENCY MEDICAL TRANSPORT

Response codes for Rescue units during patient transport will be established by the on-scene Company Officer prior to the Rescue unit leaving the scene. If the on-scene Company Officer determines that a Code 3 transport is required, the Company Officer should make every reasonable effort to have a crewmember in the Co-driver position. Emergency medical transport status shall be recorded via LV3 MCT code or via the tactical radio channel to the Alarm Room.

In the event a Rescue must change the response status from Code 2 to Code 3 while en route to a medical facility, the members should make every effort to reassign available personnel to the Co-driver position and rapid notification should be made to the Alarm Room.

During a transport, if at any time an attendant must remove their seatbelt to treat a critical patient, the following must occur:

1. The attendant must determine the urgency of the needed treatment and the most appropriate time during transport to accomplish the treatment.
2. The Driver will be notified of the needed treatment and will pull over when possible to allow for the attendant to perform the treatment. Once the treatment is completed and the attendant is seat-belted, the transport will continue.

3. If the transport needs to continue due to patient's life-threatening condition or patient care dictates, the attendant should advise the Driver that they are going to be unrestrained to perform critical treatment. The critical treatment will be performed, and the attendant will return to the belted position immediately.
4. The Driver and attendant should communicate about the condition of the patient and changes in driving conditions. If appropriate, the Driver should communicate about upcoming turns, braking or changes in traffic conditions.

DRIVER/OPERATOR, SUPERVISOR, & MANAGEMENT RESPONSIBILITIES

It is the responsibility of the Driver/Operator of each Fire Department vehicle/apparatus to comply with the Arizona Motor Vehicle Code and this policy. When determining whether a violation of this policy has occurred, the Fire Department will consider the fact that driving, and supervision of policy compliance, are inherently divided attention tasks and that human factors can sometimes cause minor deviations from policy requirements. An example of a minor deviation is momentarily exceeding maximum allowable speed by 5 mph or less. Conversely, an example of a major deviation is traveling through a controlled intersection without stopping when required or exceeding allowable speed limits by 10 mph or more; in these instances, the violation must be reported up the chain of command and will be managed through the disciplinary process.

The Company Officer or ranking Officer in the vehicle is ultimately responsible for policy compliance. The Fire Department recognizes that all fire department vehicles do not have the same tools to assist with monitoring policy compliance. For example, when vehicles do not have a passenger speedometer, it could be difficult for a Company Officer to notice **minor** deviations of speed. However, when the Company Officer or ranking Officer recognizes or should reasonably recognize a violation of policy, they have a duty to act to stop the violation.

**PHOENIX REGIONAL
STANDARD OPERATING PROCEDURES**

SPOTTING FIRE DEPARTMENT APPARATUS

M.P. 205.08A

08/20-R

Page 1 of 2

APPARATUS BACKING/FORWARD MOVEMENT – DRIVERS AND SPOTTERS

Backing of Fire Department apparatus should be avoided whenever possible. Where backing is unavoidable spotters shall be used. In addition, spotters shall be used when apparatus must negotiate forward turns with restrictive side clearances and where height clearances are uncertain.

Under circumstances where the apparatus is manned by only the driver, that driver shall attempt to utilize any available fire department personnel to act as spotters. Where no personnel are available to assist, the driver shall get out of the apparatus and make a complete 360-degree survey of the area around the apparatus to determine if any obstructions are present.

Spotters will discuss the backing plan with the driver before proceeding. A primary spotter will be designated, and the communication/warning process will be agreed upon prior to backing. The primary spotter is usually located at the left rear corner of the apparatus, but this position will be designated according to the safest backing plan agreed upon. Both door windows (driver and front passenger) should be in the down position to allow for maximum communication/hearing between spotters and the engineer/driver. Fire radio volumes will be turned down and the driver will take their headset off.

Where engine or ladder apparatus are backed, all crew members (except the driver/tiller person) will dismount the apparatus and act as spotters, including the Company Officer. Spotters should be located at as many corners as possible with at least one spotter at the left rear corner of the apparatus. Where only a single spotter is available, the spotter will coordinate with the driver to negotiate the apparatus most successfully. Rear spotters will remain a reasonably safe distance (10-15 feet) behind the apparatus and be in position to visualize the driver's eyes in the side mirror.

The apparatus shall not be backed until all spotters are in position and communicate their approval to start the backing. Spotters will remain visible to the engineer/driver. Anytime the driver loses sight of the primary spotter, the apparatus shall be stopped immediately until the spotter is visible, and the communication to continue backing is processed. Drivers will not back the apparatus faster than the spotters can safely walk backwards, allowing them to stay a safe distance from the apparatus. Spotters must be aware of approaching hazards and never place themselves between the moving apparatus and an object.

When the apparatus must be backed where other vehicle traffic exists, the emergency lights (if equipped) shall be operating and orange safety vests shall be worn by all spotters.

At night, the apparatus flood lights (if equipped) should be utilized to light surrounding objects and the spotter's location. The spotters should never use flashlights to signal the driver.

The Company Officer is responsible for compliance with this procedure and the safe backing of the apparatus.

SIGNALS

STRAIGHT BACK: Two hands above the head with palms toward face, waving back.

**PHOENIX REGIONAL
STANDARD OPERATING PROCEDURES**

SPOTTING FIRE DEPARTMENT APPARATUS

M.P. 205.08A 08/20-R Page 2 of 2

STOP: Both arms crossed with hands making a fist. Be sure to yell the stop order loud enough that the engineer/driver can hear the warning.

TURN: Both arms pointing the same direction with index fingers extended. (The direction that was agreed upon through prior verbal communication).

HARD TURN: Both arms pointing the same direction with index fingers extended with animated and exaggerated motion away from the body.

STRAIGHTEN APPARATUS: Arms and hands animated pointing up and down.

HANDOFF: Point to your eyes and then to the other spotter that the driver should look at.

LOOK AT THIS: If the spotter sees that the apparatus is approaching an object the driver may not see, **STOP** the driver and point to your eyes and then point to the object you want the driver to see.

DIMINISHING CLEARANCE: Arms out wide, as the distance gets closer, so should your arms, and at shoulder width the spotter should change the signal to **STOP**.

SLOW: If the driver is backing too fast, put your hands forward, pushing down, or stop the driver and have a discussion at the driver's window.

For further information visit <http://www.phoenixfireops.com/drivers-training> to watch the video on Safe Backing of Apparatus.

**PHOENIX REGIONAL
STANDARD OPERATING PROCEDURES**

Emergency Transportation Safe Customer Escort

M.P. 205.08B

04/18

Page 1 of 2

Purpose

The following procedure identifies factors to consider when deciding to allow a customer escort in rescues during emergency transportation to the hospital.

Background

It is the policy of the Phoenix Fire Department to extend the highest customer service to all those we encounter in our daily activities. This includes allowing escorts to travel with a patient in a rescue during emergency transportation. Each escort in a rescue increases the number of possible exposures to infections, contamination and physical dangers to fire personnel. This procedure may help to reduce the number of exposures to fire personnel while transporting patients to the emergency department. This procedure requires fire personnel to balance customer service considerations to the escort during emergency transports, versus safety in regard to physical danger, infectious exposure and possible contamination to fire personnel.

Customer Service Considerations

The following may be reasons for transporting a patient with an escort in the rescue.

- *Patient Care.* Patient care is enhanced and assisted by having an escort for the patient in the rescue. Examples may be having a mother escort her young child for comfort during patient care or fire personnel requiring an escort who has the knowledge of a second language, i.e., Spanish, American Sign Language, etc.
- *Family Member (Escort) Care.* Added value service is enhanced by having the family member escort the patient in the rescue. An example would be an elderly spouse needing to be with their critical family member who is being transported.
- *Parent Escort.* Enhances child patient care, customer service and meets legalities for transporting and treating agencies. An example would be a parent escorting an under-legal age child for treatment and consent purposes.

Use of seat belts by the escorts is mandatory. Small adults or young children should not ride in any rescue cab with airbags installed.

PHOENIX REGIONAL
STANDARD OPERATING PROCEDURES

Emergency Transportation Safe Customer Escort

M.P. 205.08B

04/18

Page 2 of 2

Exposures, Contaminations, and Physical Danger Considerations

The following considerations may be used to refuse an escort in a rescue when transporting a patient to an emergency department.

- *Infectious Exposures.* When information indicates possible infectious exposure to the patient or fire personnel by the escort. An example may be information that the escort has active TB.
- *Contamination.* When information indicates possible contamination that may expose fire personnel, equipment or vehicle. An example may be that the escort has signs of obvious body fluids on their skin, clothing or possessions.
- *Danger to Rescue Driver or Patient.* When information indicates possible physical danger to fire personnel or to the patient by the escort. An example may be that the escort exhibits signs of social or behavioral stress, or possible alcohol or drug intoxication.

Rescue Crew Responsibility

It is the responsibility of rescue personnel to discuss the above considerations with the on-scene fire officer prior to allowing an escort to travel in the rescue.

Company Officer Responsibility

It is the responsibility of the Company Officer on scene to obtain and consider the above information before a decision is made to allow an escort to ride with the patient in the rescue. When the negative considerations outweigh the positive considerations, an escort is not advised. The Company Officer on scene will make the final decision.

In the spirit of customer service, information on other means of transportation should be provided to the customer such as taxi services, private automobiles, buses, safe ride, etc.

**PHOENIX REGIONAL
STANDARD OPERATING PROCEDURES**

ADAPTIVE RESPONSE UNITS

M.P. 205.09

09/09-R

Page 1 of 1

The Adaptive Response Engine Company Program provides additional engine companies in the dispatch system. These companies should be considered for use as substitutes for companies which are out of service for extended periods of time due to training, maintenance, emergency incidents or other approved company activities. The purpose of this procedure is to provide move-up guidelines for adaptive response companies.

Move-Up Responsibility

The AHQ Chief (BC), along with the Alarm Room Supervisor and Lead Dispatchers are responsible for management of adaptive response move-ups. Together, they review the company activity calendar each morning. Special events, scheduled and unscheduled out-of-service activity and requests from field BC's and company officers must be considered.

Company officers are responsible for prompt and efficient relocation to areas when assigned by alarm. Outlying areas which normally have increased response times (due to sparser coverage) shall be covered whenever possible.

Move-Up Criteria

Adaptive Response Company move-ups will be made for both scheduled and emergency activity that places engine companies out of service for extended periods of time. Move-ups should be considered for the following situations:

1. All working incidents that will keep a number of companies out-of-service for extended periods.
2. All working incidents that have high degree of likelihood of escalating to greater alarms.
3. Extended scheduled company activity which depletes coverage in outlying areas.

Move-Up Notification

Move-ups should be made as soon as Dispatch has knowledge that coverage will be necessary. Companies identified for scheduled move-up assignments should be notified in advance if possible to allow company officers and crews to plan accordingly. Unscheduled move-up notification will be made through the normal CAD entry move-up and Channel 1 notification, unless it is convenient to notify crews via landline. The direct ring down "99" telephone notification may also be used for move-ups. When a move-up requires a company to leave their city (ie: Glendale), the appropriate Shift Commander should be notified.

Responding to Assigned Move-up location

Company officers of Adaptive Response Companies will immediately collect their crewmembers and respond to the move-up location. Move-ups will normally be under a non-emergency Code 2 status. Dispatch, however, may order a Code 3 response under critical emergency conditions. Companies should respond to their move-up assignment in an "out of service" status, while monitoring Channel One and may respond to nearby calls at the discretion of the Company Officer.

Returning to First Due Areas

Companies which have had their areas covered by adaptive response units should return to their first due area and go in service promptly when their activity has concluded. Adaptive Response Units shall stay in their move-up location (in service) until assigned by alarm to return to their first due or another location. Adaptive Response Units should monitor Channel One while returning to their own first due in an "out of service" status and respond to calls in their proximity at the discretion of the company officer.

**PHOENIX REGIONAL
STANDARD OPERATING PROCEDURES**

LADDER TENDER RESPONSE

M.P. 205.10

03/03-R

Page 1 of 1

Ladder Tenders

The objective of operating a ladder tender in conjunction with a ladder truck housed at a fire station is to provide a full level of truck capabilities, while extending the service life of the larger, more costly apparatus. Ladder tender (LT) vehicles are purchased at a fraction of the cost of full-sized truck companies and are intended to be utilized wherever they are deemed adequate (i.e., E.M.S. calls, special duties, extrications, etc.). Ladder tenders may provide Basic Life Support (LT) or with an Advanced Life Support Team (LPT).

Response to Structural Alarms

When responding from quarters, a complete crew will respond on the Ladder Truck to all structural assignments of 3-1 or greater magnitude. The company officer may choose to bring along the Ladder Tender to increase the flexibility of the company at the scene (i.e. two-piece company).

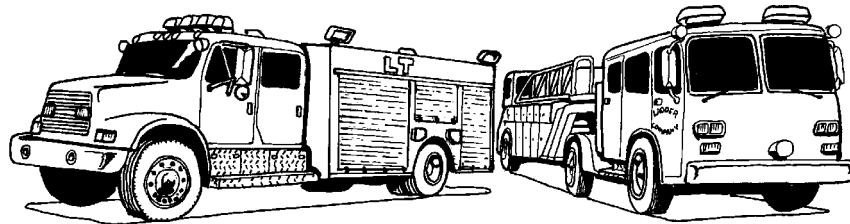

If the crew is dispatched to a structural assignment while out of quarters in the Ladder Tender, the company will respond to the incident in the Ladder Tender. Dispatch must be advised that response is with a Ladder Tender. The TRO will then relay this information to all responding units. When responding with a Ladder Tender, it will sometimes be necessary for Ladder Tender personnel to use hand ladders or other equipment off engine companies at the scene. A pessimistic approach is essential, and if any indicators suggest that the apparatus may not be adequate to handle the incident (i.e., multi-story building, ladder pipe potential, etc.) a backup Ladder Truck should be requested.

Response to B.L.S. Dispatches

The officer in charge of a two-piece truck company may choose to respond to a B.L.S. dispatch with a minimum four-member crew on the Ladder Tender.

In summary, a pessimistic approach is required when a question exists as to whether a ladder tender response is adequate for an incident. A good rule to follow: when in doubt, request a Ladder company backup.

**PHOENIX REGIONAL
STANDARD OPERATING PROCEDURES**

WATER TENDER RESPONSE

M.P. 205.11

01/95-R

Page 1 of 1

The following policy regulates the dispatch, response and use of water tender apparatus. All company officers will use their discretion in calling for water tender assistance and should be alert to areas in their response zones that will require the additional water carried on water tenders.

Company officers having a water tender assigned to their station can take the water tender with their engine (but not in lieu of) when the water tender is needed due to limited water supply. This procedure is not intended to provide for the use of water tenders as two-piece companies where a water supply is readily available.

In addition to the above, a water tender may be special called to any incident where required. Command will specify either a water tender with driver only, or a full crew. When a full crew is requested, the assigned company will respond with the water tender plus their regular apparatus unless otherwise instructed. When a water tender is requested with a driver only, the Company officer is responsible to assign a qualified driver/pump operator.

If the company housed with the closest available water tender is not in quarters, Alarm will dispatch an available company to pick up the water tender and respond.

The water tender will always retain its home station identification regardless of the assigned crews. Example: "Engine 30 responding with water tender ().

Personnel assigned to stations housing water tenders will maintain and service the water tenders in accordance with the Phoenix Fire Department Operations Manual, Volume III, Section 3. Companies assigned to respond with a water tender will service, clean and restore the apparatus to an acceptable standard condition of readiness upon completion of the incident.

Engineers may be assigned to water tenders on Constant Manning basis during periods of heavy brush fire activity.

**PHOENIX REGIONAL
STANDARD OPERATING PROCEDURES**

SKY HARBOR RESPONSE AVIATION EMERGENCIES

M.P. 205.13

12/12-R

Page 1 of 5

PURPOSE

The purpose of this procedure is to establish guidelines for the response of fire department personnel and equipment to aircraft emergency situations occurring at Phoenix Sky Harbor International Airport. The procedure outlines responsibilities for **both** on and off airport fire personnel and details dispatch terminology, apparatus response, standby locations, and staging areas.

DISPATCH TERMINOLOGY

Aircraft emergencies are broken down into three categories: Alert 1, Alert 2 and Alert 3. These categories are defined by the Federal Aviation Administration (FAA) to provide standard descriptions and terminology for aircraft emergencies.

Alert 1: Indicates an aircraft is having minor difficulties (i.e., minor oil leak; one engine out on a three or four-engine commercial aircraft or one engine out on a two-engine general aviation aircraft; fire warning lights; etc.). A safe landing is expected.

Alert 2: Indicates that an aircraft is having major difficulties (i.e., a positive indication of fire on board the aircraft; faulty landing gear; no hydraulic pressure; engine failure on a two-engine large aircraft; etc.). A difficult or crash landing may be expected.

Alert 3: Indicates that an aircraft has crashed on or off the airport, or there is a high probability the aircraft will crash, or the pilot has indicated that the aircraft landing gear will not work and, therefore, the pilot will have to crash land on the airport.

SKY HARBOR RESPONSE - AVIATION EMERGENCIES

The type of fire department response at Sky Harbor will be dictated by a fire captain at Sky Harbor Airport Fire Station #19. The captain will assess the information he/she has received from the FAA Control Tower or other source, and direct fire Dispatch to send the appropriate level of alert response. In all cases, the captain will take a pessimistic view and select the alert level most appropriate for the expected problems.

An Alert 1 = **ARF Response**, consisting of: Foam 1, Foam 2, Foam 3, Attack 19, E19 and BC19.

An Alert 2 = **ARF2-1 Response**, consisting of: Foam 1, Foam 2, Foam 3, Attack 19, E19, BC19, three (3) off-airport engine companies (one (1) which will be A.L.S.), one (1) ladder company.

An Alert 3 = **ARF1A Response**, consisting of: Foam 1, Foam 2, Foam 3, Attack 19, E19, BC19, four (4) off-airport engine companies (two (2) of which will be A.L.S.), Support 8, two (2) ladder companies (one (1) will be a platform), one (1) utility truck, one (1) Command Van (CV-1), three (3) rescues, and 6 (6) additional Battalion Chiefs, SDC, NDC.

**PHOENIX REGIONAL
STANDARD OPERATING PROCEDURES**

SKY HARBOR RESPONSE AVIATION EMERGENCIES

M.P. 205.13

12/12-R

Page 2 of 5

STAFF REDUCTIONS

Squad19 / Attack 19 serves as the same crew with capabilities of two different apparatus. Squad 19 is a smaller more mobile unit for dispatches to medical, car fires, and special duty calls. Attack 19 is a foam truck for use with fuel spills and alerts. If Squad 19 / Attack 19 is dispatched on another call, along with E19, this causes a significant reduction of available personnel for aircraft emergencies at the airport. In this case, the alert assignment should be increased to cover for staff reductions.

RESPONSE AND STANDBY POSITIONS

On Alert 1's -- Station 19 with Foam 2 out of Station 29 will handle the emergencies along with Battalion19, Foam 1, Foam 2, Foam 3, Attack 19 and E19, and will respond to their ARFF staging locations along the runway.

On Alert 2's -- Foam 1, Foam 2, Foam 3, Attack 19 and E19, BC19, will respond to their ARFF staging locations along the runway. Off-airport units will respond to Gate 118 - east of Fire Station 29 (3949 E. Air Lane), Level II staging.

On Alert 3's -- Foam 1, Foam 2, Foam 3, Attack 19 and E19, BC19, will respond to the crash site. All off-airport units will also respond directly to the crash site, unless Command directs them to a level two staging area -- Gate 118, east of Fire Station 29 (3949 E. Air Lane). The Battalion chief will respond directly to the crash site and assume Sky Harbor Command. Sky Harbor Airport ARFF staging locations in general are:

Foam 1 will be near the west-end of the runway.

Foam 2 will be near east-end of the runway; and

Foam 3 will be near the mid-point of the runway;

Attack 19, E19, & BC19 will stage near the midpoint of the runway with Foam 3.

Each position will be at least 500 feet away from the runway.

STAGING

The first off-airport unit to arrive at the staging location will assume staging sector responsibilities and announce "staging." Additional equipment will be assembled in an organized manner. Command may relocate staging as needed. All radio communications will use the radio designation "staging."

**PHOENIX REGIONAL
STANDARD OPERATING PROCEDURES**

SKY HARBOR RESPONSE AVIATION EMERGENCIES

M.P. 205.13

12/12-R

Page 3 of 5

TACTICAL BENCHMARKS

Below listed are tactical benchmarks to consider for any type of aircraft accident.

1. The first arriving unit should assume command and determine if the flight crew has initiated emergency evacuation procedures. Fire Department personnel should make every effort to prevent an unnecessary evacuation by immediately contacting the flight crew and reporting exterior conditions to them.
2. If emergency evacuation is in progress, assist evacuation of passengers and/or provide them a path of egress, by discharging **Class B foam only**, from apparatus. Create a path through the burning flammable liquid from the escape exit door to a safe area. If **Class B foam** is not available, use large volumes of water. Protect the aircraft fuselage from direct flame impingement since fire can burn through fuselage within 60 seconds. Ensure your own supply line. Master stream appliances (Stang Guns) utilizing fog patterns; provide quick water in large volumes to protect passengers during evacuation.
3. Deploy an attack line to the aircraft's interior, without inhibiting passenger egress. Fire intensity will require the use of 1-3/4" or 2" hand-lines, utilizing fog patterns.
4. Provide interior ventilation as soon as possible inside the aircraft. Fatalities in survivable aircraft crashes are usually due to smoke inhalation. Use wide angle fog patterns from hand-lines to ventilate. Positive Pressure Ventilation (PPV) is beneficial, however may not be initially expedient. Pressurize from unburned area and provide ventilation exit in fire area. Ventilation should be started at the same time as the attack lines are put into operation, if possible.
5. Aircraft have common attic spaces, large open cargo areas (in belly), and sidewalls that can have running fires in these confined spaces. Consider using penetrating nozzles to reach fire in confined spaces or any location where interior attack lines cannot be deployed.
6. Use ladders at the aircraft at the wing or other accessible points. Some aircraft may require aerial ladders to reach access points.
7. Obtain primary and secondary all clears. Never assume absence of survivors.
8. Provide for interior lighting.
9. Request Police Department secures the scene and provides a holding area to assist in the control of the ambulatory passengers.
10. Establish both fire and medical sectors as soon as possible. Designate sectors for both sides of the aircraft to protect the escape routes and manage the evacuated passengers, assign sectors to address scene lighting, extrication, treatment, transportation and site safety.
11. Consider establishing a branch level command system to address fire and medical operations separately.
12. Ensure necessary amounts of foam extinguishing agents to amounts of flammable liquids on fire.

**PHOENIX REGIONAL
STANDARD OPERATING PROCEDURES**

SKY HARBOR RESPONSE AVIATION EMERGENCIES

M.P. 205.13

12/12-R

Page 4 of 5

13. Maintain effective foam blanket to prevent ignition / re-ignition of fuel.
14. Maintain awareness of electricity generated by large aircraft, it is sufficient to seriously injure personnel and/or ignite fuel sources.
15. Jagged metal from aircraft can cut through protective clothing and hose lines.
16. To gain access into the fuselage, use the wing area or a platform ladder truck to work from. The optimum place to cut is around windows, doors, and roof area. Hydraulic powered tools (Hurst, Holmatro, etc.) and pry bars do not work well on aircraft metals due to the lack of solid supports to work against.
17. If saws are used for extrication or ventilation, arcing and sparking will need to be suppressed with water/foam from hand lines. Maintain integrity of foam blanket on the flammable liquids. Be aware that aircraft have numerous high pressure hydraulic lines that can cause serious injury if cut or broken.
18. Ensure back-up crew/s with charged hose lines in place to protect all personnel who will be working inside the spilled flammable liquid areas. All personnel working in these areas shall be fully turned out with protective gear and S.C.B.A. face piece on.
19. Have police secure a route of ingress / egress, to permit emergency equipment, particularly ambulances, unimpeded movement to / from the incident.
20. Do not allow any overhaul operations to take place until all investigative agencies are finished or unless needed to suppress fire.
21. Large aircraft have oxygen cylinders on board that can explode, become missiles, and/or accelerate the spread of fire.
22. Adopt a defensive mode of operation, as needed, to protect personnel and exposures.
23. Request the Alarm Room notify the National Transportation Safety Board (NTSB). Notification can be made contacting the FAA Air Traffic Control Tower at Sky Harbor Airport or by calling Sky Harbor Communications at 273-3311.
24. Request the Alarm Room notify area hospitals, Salvation Army, Red Cross, County Emergency Disaster Coordinator, C.I.D. Team and Sky Harbor Communication Center.
25. For off airport responses consider requesting ARFF foam trucks, Medical Support 19 or Foam 34, if they have not been dispatched.
26. Have an airline representative report to the Command Post along with the liaison from the Police Department, Aviation Department, and any other agency that can assist with the incident.
27. Send a fire department representative to staff the Airport Emergency Operations Center (EOC).

PHOENIX REGIONAL
STANDARD OPERATING PROCEDURES

SKY HARBOR RESPONSE AVIATION EMERGENCIES

M.P. 205.13

12/12-R

Page 5 of 5

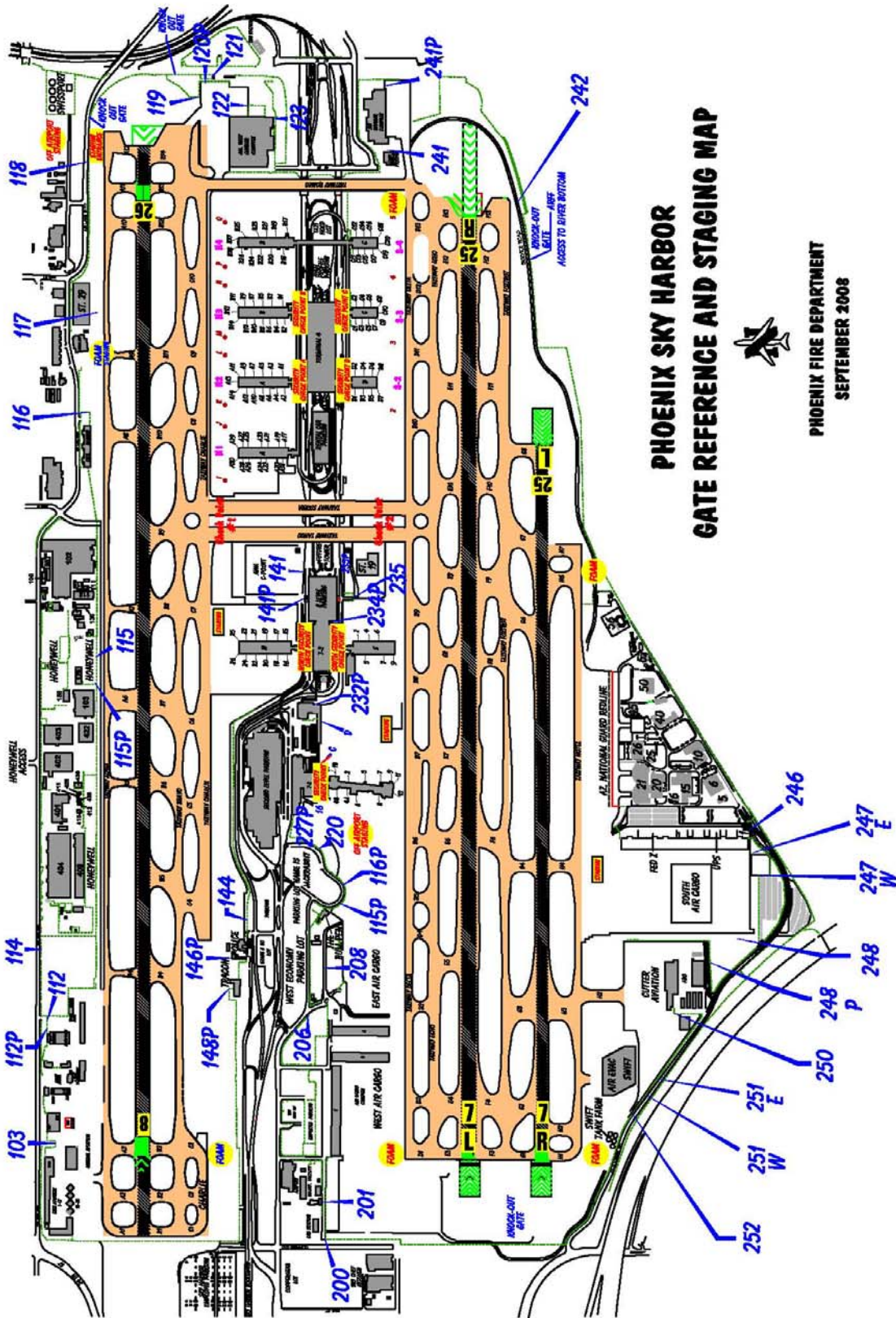

**PHOENIX REGIONAL
STANDARD OPERATING PROCEDURES**

GOODYEAR AIRPORT

M.P. 205.13A

12/12-R

Page 1 of 2

Purpose

This procedure describes the response of fire department units to an aircraft emergency at Goodyear Airport.

An Alert 1 response consists of one (1) Engine Company.

An Alert 2 response consists of two (2) engine companies (one of which will be A.L.S.), Foam 34, one (1) ladder company and one (1) chief. In addition, the Goodyear Fire Department will respond with one (1) engine company and one (1) chief. The first fire department unit on the scene will assume command of the incident.

An Alert 3 response consists of two (2) engine companies (one of which shall be A.L.S.), Foam 34, one (1) ladder company, one (1) utility truck and one (1) chief. The first fire department unit on the scene will assume Command of the incident. Should the incident involve a larger aircraft, Command should request additional resources.

ALERT 1 AND 2 STAGING

On Alert 1's and 2's, all fire department units shall respond to the base of the Goodyear Control Tower and stage until the aircraft has landed. If a crash occurs, respond from your standby location to the crash site. If traveling on the runway is necessary, do so only after a determination has been made that the runway has been closed to all aircraft.

ALERT 3

On Alert 3's, all companies shall use standard response and staging procedures. If traveling on the runway is necessary, do so only after a determination has been made that the runway has been closed to all aircraft.

The Goodyear Control Tower has communication capabilities with the Phoenix Fire Department Dispatch Center via direct line. The Goodyear Control Tower is staffed from 0600 to 2100 hours, seven (7) days a week.

All tactical benchmarks listed for Sky Harbor response apply for any type of aircraft accident. See Sky Harbor Response M.P.

PHOENIX REGIONAL STANDARD OPERATING PROCEDURES

GOODYEAR AIRPORT

M.P. 205.13A

12/12-R

Page 2 of 2

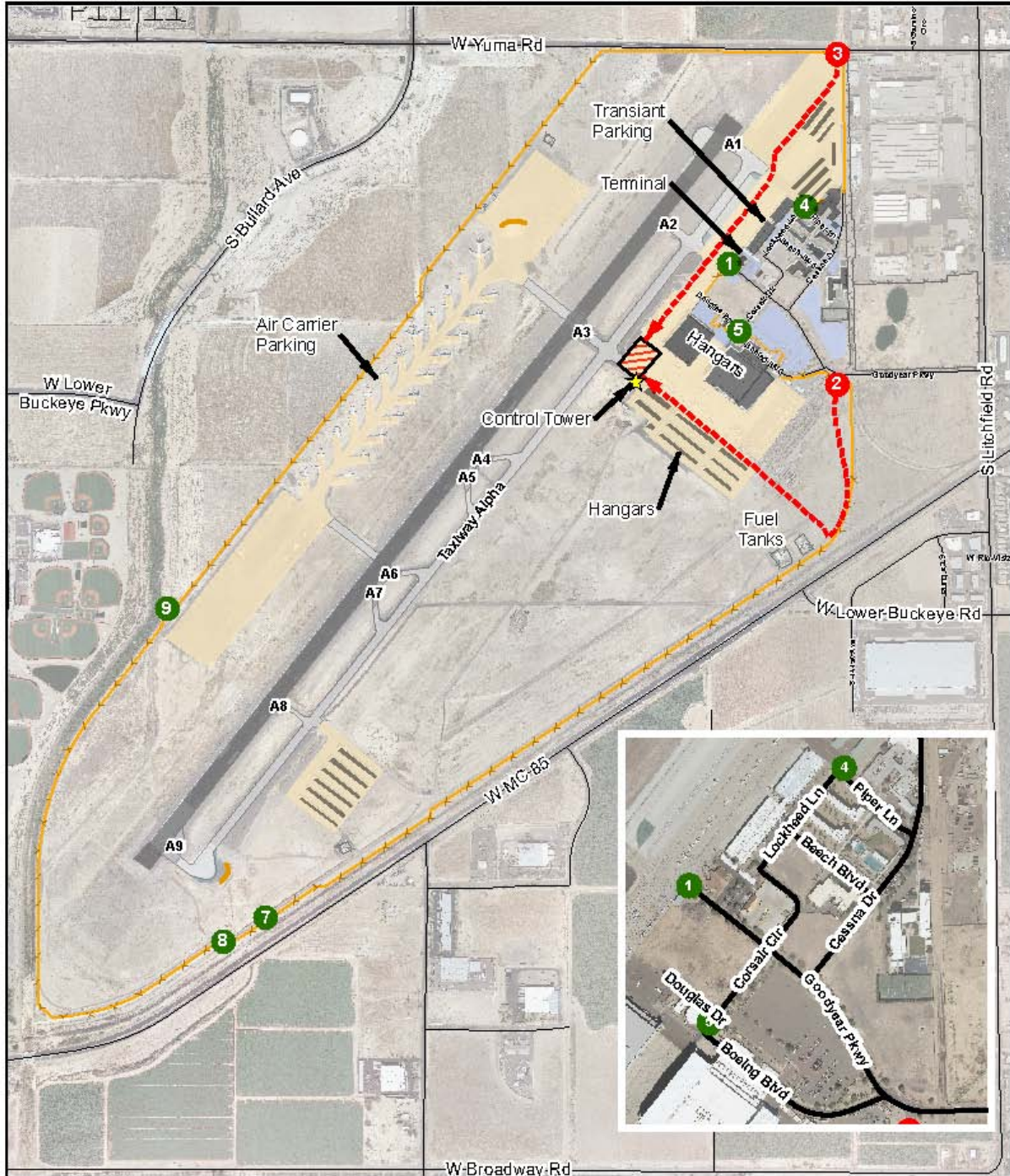

Legend

- | | | |
|------------------|--------------------|-------------------------|
| Emergency Access | Fence | Parking |
| Staging Area | Blast | Apron |
| Gate | Security Perimeter | Runway |
| Option Gate | Unknown | Taxiway |
| Gate | | Taxiway High Speed Exit |



0 250 500 1000
Feet

Goodyear Fire Map

June 8, 2012

Goodyear GIS

Phoenix-Goodyear Airport Bagging Area.mxd

**PHOENIX REGIONAL
STANDARD OPERATING PROCEDURES**

DEER VALLEY AIRPORT

M.P. 205.13B

12/12-R

Page 1 of 2

Purpose

This procedure describes the response of fire department units to an aircraft emergency at Deer Valley Airport.

RESPONSE

An Alert 1 response consists of one (1) engine.

An Alert 2 response consists of two (2) engine companies (one of which shall be A.L.S.), one (1) ladder company, one (1) battalion chief, and T36 if available.

An Alert 3 response consists of two (2) engine companies (one of which shall be A.L.S.), one (1) ladder company, one (1) rescue, one (1) utility truck, one (1) battalion chief, and T36 if available.

Should the incident involve a larger aircraft, Command should request additional resources.

ALERT 1 AND 2 STAGING

On Alert 1's and 2's, all companies shall respond to the Deer Valley Airport main entrance at 7th Ave. and Deer Valley Rd. and stage until the aircraft has landed. Staging location will be just inside gate #2 (on east side of restaurant and activated by opticom). Should a crash occur, companies should respond from the standby location to the crash site. If traveling on a runway is necessary, do so only after a determination has been made that the runway has been closed to all aircraft. The Deer Valley Control Tower has a fire radio and can communicate with Fire personnel. The Deer Valley Control Tower is staffed from 0600 to 0000 hours, seven (7) days a week.

ALERT 3

On Alert 3's, all companies shall use standard response and staging procedures. If traveling on a runway is necessary, do so only after a determination has been made that the runway has been closed to all aircraft. Fire personnel can communicate with tower personnel on the tactical fire channel Fire department radio.

All tactical benchmarks listed for Sky Harbor response apply for any type of aircraft accident. See Sky Harbor Response M.P.

PHOENIX REGIONAL
STANDARD OPERATING PROCEDURES

DEER VALLEY AIRPORT

M.P. 205.13B

12/12-R

Page 2 of 2

PHOENIX - DEER VALLEY AIRPORT

FREQUENCY GUIDE
 NORTH TOWER (7L/25R) - 120.2
 SOUTH TOWER (7R/25L) - 118.4
 GROUND - 121.8

RUNWAY DIMENSIONS
 7L / 25R - 4,508' x 75'
 7R / 25L - 8,197' x 100'

- LEGEND**
- HAZARDOUS MATERIAL STORAGE
 - HYDRANTS
- NOTE:**
 PEDESTRIAN GATES
 BETWEEN EACH HANGAR

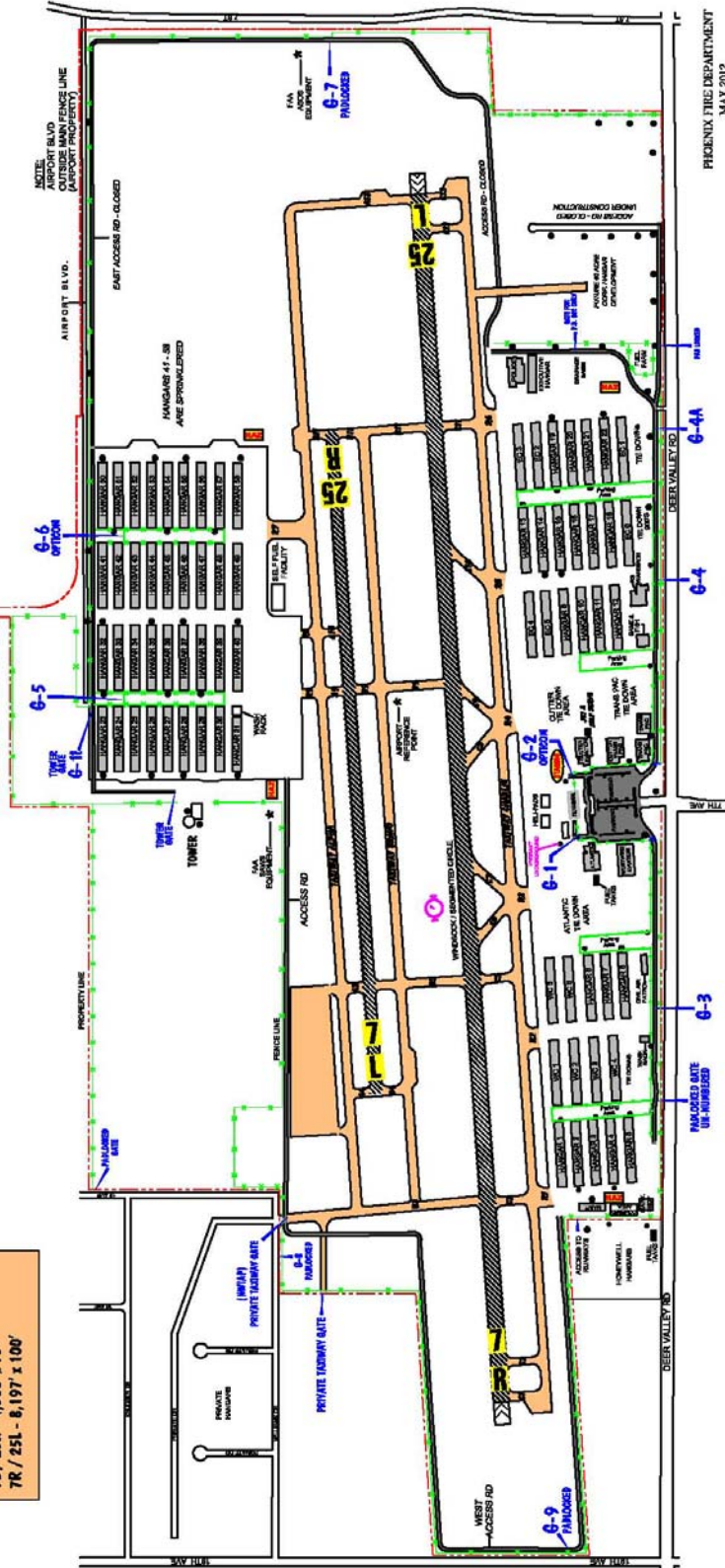

PHOENIX FIRE DEPARTMENT
MAY 2012

**PHOENIX REGIONAL
STANDARD OPERATING PROCEDURES**

GLENDALE AIRPORT

M.P. 205.13C

Rev 12/12

Page 1 of 3

PURPOSE

The purpose of this procedure is to establish guidelines for the response of Fire Department personnel and equipment to an aircraft emergency at the Glendale Airport.

DISPATCH TERMINOLOGY

Aircraft emergencies are broken down into three categories: Alert 1, Alert 2, and Alert 3.

Alert 1: Indicates an aircraft is having minor difficulties (i.e., a minor oil leak; one engine out on a three or four-engine commercial aircraft or one engine out on a two-engine general aviation aircraft; fire warning lights; etc.) A safe landing is expected.

Alert 2: Indicates that an aircraft is having major difficulties (i.e. a positive indication of fire on board the aircraft; faulty landing gear; no hydraulic pressure; engine failure on a two-engine large aircraft; etc.) A difficult or crash landing may be expected.

Alert 3: Indicates that an aircraft has crashed on or off the airport, or there is a high probability the aircraft will crash, or the pilot has indicated that the landing gear will not work, and therefore, they will have to crash land on the airport.

GLENDALE AIRPORT RESPONSE

Alert 1: Response consists of one (1) Engine Company.

Alert 2: Response consists of two (2) engine companies (one A.L.S.), one (1) ladder company, and one (1) brush truck and one (1) Battalion Chief.

Alert 3: Response consists of two (2) engine companies (one A.L.S.), one (1) ladder company, one (1) brush truck, one (1) utility truck, one (1) foam capability (1) Battalion Chief, and a Glendale shift commander. Should the incident involve a larger aircraft, Command should request additional resources.

ALERT 1 AND 2 STAGING

Alert 1 and Alert 2 incidents all companies shall respond to the Glendale Control Tower at gate #9 and stage until the aircraft has landed. Gate #9 has preemption / opticom light and a Knox box lock is located on the fence. The Glendale Control Tower has a Fire Department radio and can communicate with fire department personnel on all hazard channels. Should a crash occur, companies would respond from the standby location, (at gate #9 - The tower) to the site of the crash.

If traveling on the runway is necessary, do so only after confirming with the Glendale Control Tower that the runway has been closed to all aircraft.

PHOENIX REGIONAL
STANDARD OPERATING PROCEDURES

GLENDALE AIRPORT

M.P. 205.13C

Rev 12/12

Page 2 of 3

The Glendale Control Tower is staffed Monday through Friday from 0600 hours to 2030 hours and Saturday and Sunday from 0700 hours to 1900 hours, including holidays. Airport management is on site Monday through Friday from 0530 hours to 2200 hours and Saturday and Sunday from 0700-1700. There are currently no security personnel on the premises. The point of contact is the Airport Manager, Walter L. Fix who can be reached at 623-930-4744 or 623-930-2188 or on his cell phone 623-606-2582.

ALERT 3

For Alert 3 incidents, all companies shall respond directly to the crash site.

If traveling on the runway is necessary, do so only after confirming with the Glendale Control Tower that the runway has been closed to all aircraft.

MISCELLANEOUS

- Incident command should consider additional foam / crash units if needed.
- Command should consider placement of a liaison in the control tower to assist with communication between tower and Command.
- Companies responding should request through Phoenix Fire Dispatch Center the number of passengers on board, the amount of fuel on board the aircraft, and aircraft type if possible.

PHOENIX REGIONAL
STANDARD OPERATING PROCEDURES

GLENDALE AIRPORT

M.P. 205.13C

Rev 12/12

Page 3 of 3

GLENDALE MUNICIPAL AIRPORT
6801 N. Glen Harbor Blvd
623-930-2188 Operations

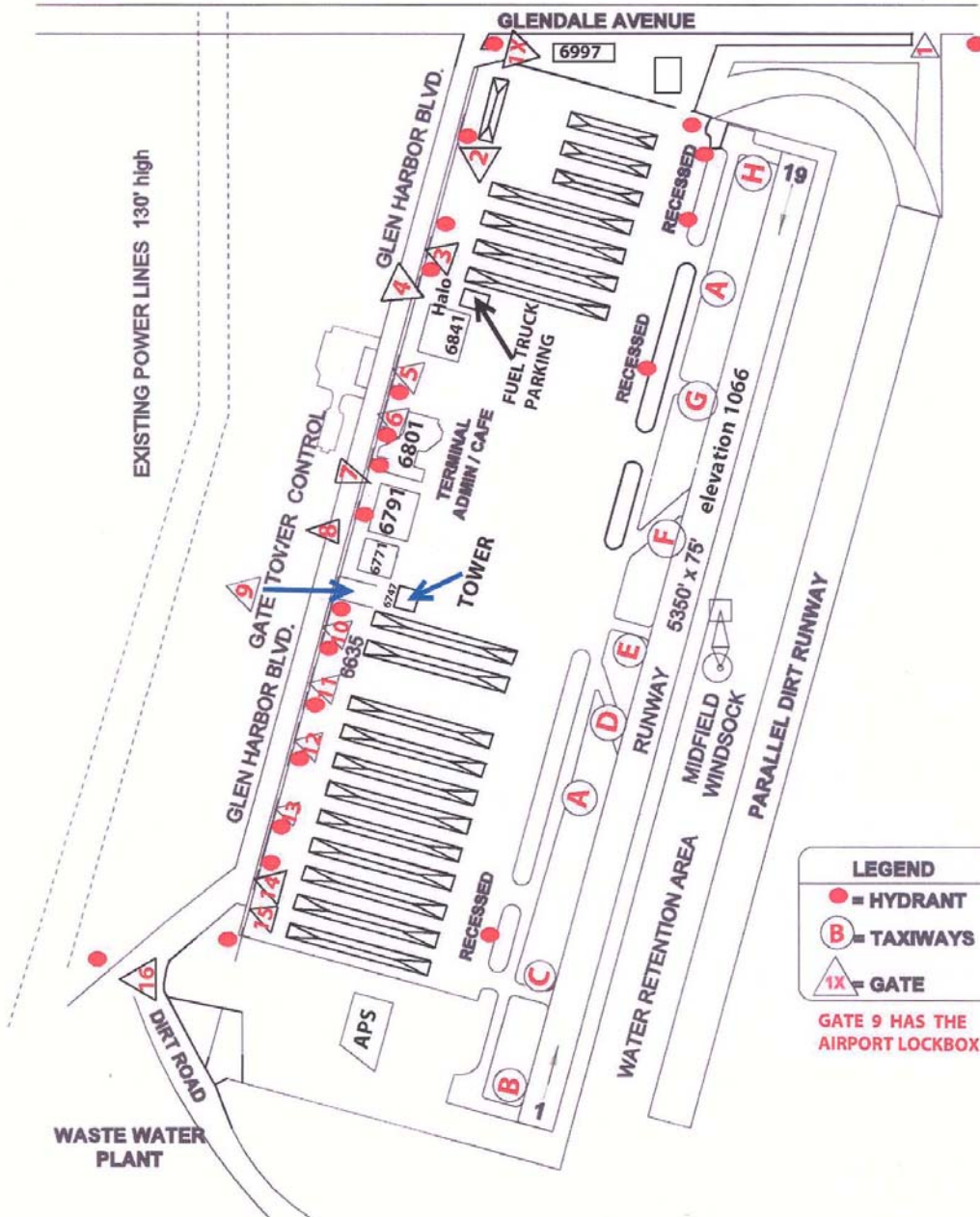
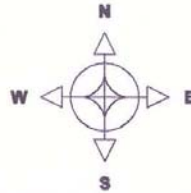

LEGEND

- = HYDRANT
- B = TAXIWAYS
- △ 1X = GATE

GATE 9 HAS THE AIRPORT LOCKBOX

**PHOENIX REGIONAL
STANDARD OPERATING PROCEDURES**

FOAM UNIT RESPONSE – OFF AIRPORT

M.P. 205.14

12/12-R

Page 1 of 2

The following procedure is for the dispatch and response of airport units off the airport and for Foam 34 and Foam 54 utilization.

The following units are available for response to off-airport incidents requiring large quantities of Class B extinguishing agents:

<u>Location</u>	<u>Unit</u>	<u>Water - AFFF (gal)</u>	<u>Dry Chemical (lbs)</u>
Sky Harbor	ATTACK 19 (4 Person Unit)	3,000 - (600)	500 lbs
	Foam 1 (2 Person Unit)	4,000 - (600)	500 lbs
	Foam 2 (2 Person Unit)	4,500 – (600)	500 lbs
	Foam 3 (3 Person Unit)	4,500 - (600) Halotron - 500 Lbs.	500 lbs
Station 34	Foam 34	700 (foam concentrate)	
Station 54	Foam 54	900 (foam concentrate)	

The agents carried are Aqueous Film Forming Foam (AFFF) and Super K dry chemical.

(Note: a limited quantity of Polar Solvent Type AFFF is carried on Support 4.)

It is important to remember that AFFF will not work well on free-flowing burning fuels or fuel burning under pressure. However, dry chemical agent is very effective under either of these conditions. The AFFF and potassium base dry chemical carried on these units are compatible when used simultaneously.

Circumstances that may require large volume foam and/or dry chemical equipment include:

1. Plane crash with or without fire;
2. Flammable liquid tanker accidents including spills with or without fire;
3. Railroad tanker incidents involving flammable liquids;
4. Interior fires involving petroleum products;
5. Flammable liquid bulk storage plants.

Responsibility

Fire Ground Command must immediately recognize that a major Class B or potential fire is a critical fire ground factor. Initial plan development should include large volume foam and/or dry chemical applications and should be implemented quickly with ARFF units "special called".

**PHOENIX REGIONAL
STANDARD OPERATING PROCEDURES**

FOAM UNIT RESPONSE – OFF AIRPORT

M.P. 205.14

12/12-R

Page 2 of 2

First due Response Areas

Foam 34 and 54 --automatic response anywhere in the City.

Deer Valley has no chemical unit--north of Glendale Avenue.

Sky Harbor Foam unit with dry chemical capability—5 mile radius of airport and reserve units valley wide- depending on availability.

Dispatch Procedures for Units

Upon special call, the Dispatch Center will dispatch units to Deer Valley or Sky Harbor units depending on location. Foam 34 and /or 54 will be dispatched automatically to all flammable liquid incidents. Sky Harbor ARFF equipment will be dispatched off the airport within a 5 mile radius for an aircraft incident. If ARFF equipment is request from Command for any other incident it will require coordination with Sky 1 (or her/his designee) to assure that FAA Index D is maintained with the remaining foam units.

For off airport ARFF response utilizing Sky Harbor units, BC19 will be provided an ARFF Captain and Engineer from Station 19 with reserve foam trucks.

Airport Foam units are large vehicles ill-equipped for Code Three response and have poor maneuverability in city traffic. It is essential that any foam truck operator exercise great caution when driving through traffic and consider that ARFF units are not structurally designed for long road response.

Foam 34

Foam 34 will respond as a 2-piece company with an assigned engine company. The engine company will assume the identity of Foam 34 when assigned to respond with this unit.

The pumper of the engine company will be responsible for laying supply lines to be the manifold, if necessary. If available, Engine 34 will be assigned to respond with the Foam unit. When Engine 34 is not readily available, another engine company may be assigned to pick up the Foam unit. Dispatch will make this assignment.

Additional Foam

When it is apparent that additional foam concentrate will be needed, Command must coordinate through Dispatch or Resource Management on the scene for additional agent. Presently, agent is available at Sky Harbor AFFF mil spec 3% and Dry Chemical, Resource Management, Station 34 and contract vendor. This need should be identified as early as possible.

**PHOENIX REGIONAL
STANDARD OPERATING PROCEDURES**

FREEWAY RESPONSE

M.P. 205.15

12/98-R

Page 1 of 8

SCOPE

Freeway incidents commonly involve multiple vehicles, multiple patients, and often vehicle fires. A major potential also exists for flammable liquid spills, fires or hazardous materials incidents.

This plan provides specific information and procedures to be used in handling incidents occurring on the freeway system. Unless specifically superseded by this plan, all other Phoenix Fire Department procedures shall be used in operations occurring on freeways.

DISPATCH INFORMATION

When dispatching an incident on a freeway, Dispatch will provide the following information:

1. Type of Incident
2. Location
 - a. Freeway or access frontage
 - b. I-17 or I-10 (Black Canyon or Maricopa), Papago I-10, SR-51 Squaw Peak, etc.
 - c. Cross street
3. Direction of Travel
 - a. If information indicates difficulty can be expected in reaching or locating the scene, Dispatch will send a second company from the opposite direction.
4. Traffic Conditions (if known)

RESPONSE

Dispatch may receive information on a freeway incident from the Department of Public Safety (D.P.S.) or a variety of other sources. Communications must be established early and maintained with D.P.S. to assure that needed information is exchanged regarding the incident.

In most cases, a freeway incident will be reported by the Arizona Department of Public Safety (D.P.S.). Additionally, D.P.S. may arrive first at an incident and may be able to provide updated information on traffic conditions and access. Any Information received from D.P.S. must be relayed immediately to responding fire companies.

The Company Officer on a responding unit is responsible for redirecting other companies or having the Dispatch Center send additional companies if it becomes apparent that the first company will be unable to reach the incident due to traffic congestion. If access problems are anticipated, or if the direction of travel is unknown, the Dispatch Center may send companies from opposite directions.

CANCELLED ENROUTE

When responding to freeway emergencies and D.P.S. is on-scene and has assumed command, it will be the responsibility of the D.P.S. Command Officer to evaluate the following factors before canceling any fire units.

**PHOENIX REGIONAL
STANDARD OPERATING PROCEDURES**

FREEWAY RESPONSE

M.P. 205.15

12/98-R

Page 2 of 8

Auto Accident (962)

- | | |
|--------------------------|---|
| a. Mechanism of injury | g. Neck pain |
| b. Loss of consciousness | h. Paralysis of any type |
| c. Slurred speech | i. Numbness |
| d. Pregnant females | j. Chest pain |
| e. Ejected patients | k. Other hazards: fuel,
unknown substances, etc. |
| f. Fractures | |

If the D.P.S. Command Officer does not feel comfortable evaluating these medical triage decisions, the officer will have the first due company respond for medical evaluation.

If fire units are canceled en-route, they should not proceed into the scene unless re-dispatched. This creates unnecessary congestion and other traffic problems at the scene.

APPROACH AND STAGING

Units responding to calls on the Freeway will respond Code 2 while on the Freeway mainline. However, alternating headlights and rear flashers may be used. Units should attempt to reach the scene in the direction of the reported incident unless otherwise instructed by D.P.S.

In some cases, D.P.S. may advise the best access is via the access frontage or by traveling against the normal traffic flow. Units should proceed in the opposite direction of normal flow only at the specific request of D.P.S. when it is assured that all traffic has been stopped. Fire units should confirm traffic is stopped before entering the freeway against traffic.

On multiple unit responses, the first unit approaching or entering the freeway within a mile of the incident will report its identity, location and direction. Other units approaching will then stage Level I, preferably near an on-ramp to avoid premature commitment to the mainline or access frontage. Where appropriate to do so, these companies may block the access road to prevent additional traffic from entering the freeway.

It is the responsibility of the first unit to direct other units via alternate access if unable to reach the scene. Specific directions should be given regarding approach and direction for other companies when problems are encountered.

COMMAND

The first unit arriving on the scene of a multiple unit incident will determine if the D.P.S. has established a Command Post. If Incident Command is in place, the first arriving

fire department unit shall meet with the D.P.S. Incident Commander for a briefing. The following should be covered:

1. Traffic Conditions
 - a. Stopped
 - b. One lane open
 - c. All lanes open

**PHOENIX REGIONAL
STANDARD OPERATING PROCEDURES**

FREEWAY RESPONSE

M.P. 205.15

12/98-R

Page 3 of 8

2. Fire/No Fire (smoke showing, working fire, fully involved) A follow-up report should indicate:
 - a. Number of patients/extent of injuries
 - b. Extrication Needed
 - c. Evacuation
 - d. Hazardous Materials Spill
 - e. What's Burning, including any hazardous product

3. Call for Necessary Help
 - a. Stage additional assistance as needed

COMMAND POST LOCATION

The Command Post location should be carefully chosen for major incidents to provide access and a good view of the scene.

The access frontage or an overpass provides a view of the scene for incidents on depressed roadway sections.

UNIFIED COMMAND

It's important to establish a single "Unified Command" Post as soon as possible. Key agencies at this Command Post will be the fire department, the Arizona Department of Public Safety (DPS), the Arizona Department of Transportation (ADOT), and if freeway traffic is being diverted to city streets, the appropriate city police will need to be party to the Command Post operation.

It's important to physically assemble all representatives at a single location as soon as possible. This may require the initial fire department commander to search out the DPS and ADOT representatives. Once a physical location for the Command Post is determined, all agencies should advise their dispatchers of that location.

Dispatch centers must be advised of any changes in the Command Post location (i.e. moving into the fire department's Command Van and its physical location).

When the fire department is first to arrive, the Incident Commander must announce the command vehicles identity (i.e. E14, Battalion 3) and the vehicle's location (i.e. 50 feet east of the accident). Dispatch will relay the location to DPS. Dispatch must be advised of any change of Command Post locations.

Use of the fire department sector vests and Command Officer vests will facilitate the Command Operation and allow other agencies to find key persons at the incident.

LIAISON WITH DPS

In some occasions, particularly early in the incident, it may be more appropriate for a fire department representative to serve as a liaison officer to the DPS Incident Commander. This liaison should be a temporary function and should end when all agency representatives assemble Command Staff at a unified Command Post.

**PHOENIX REGIONAL
STANDARD OPERATING PROCEDURES**

FREEWAY RESPONSE

M.P. 205.15

12/98-R

Page 4 of 8

When the need to shut down freeway traffic is indicated, Command must make a joint assessment of conditions with the D.P.S. and police department. The logistical and traffic congestion problems created by a complete shut down of freeway traffic may last for hours and affect a large area of the city. A decision to close the freeway must recognize these factors in relation to the safety of the incident.

SPECIAL CONSIDERATIONS

Each company officer is responsible to research or know the location of hydrants and access to the freeway. Water supplies and other factors must be pre-planned by the first due officers. Some typical factors which must be considered:

EXAMPLES:

1. Early call for additional companies to handle lines that may have to be extended long distances over obstacles.
2. Relay pumping probabilities.
3. Special equipment needs (tenders, foam, sand, diking materials, wreckers, etc.).
4. Early call for traffic control.
5. Sewers, drains, and pump stations (when dealing with spilled products).
6. Peak traffic hours create congestion and delays.
7. Access to the freeway (ladders, on/off ramps, etc.).
8. Hazardous Materials Team.

APPARATUS PLACEMENT

Whenever possible, place apparatus between oncoming traffic and operating personnel in order to protect the scene from approaching vehicles. Warning lights must be visible to oncoming traffic. Avoiding unnecessary blocking of traffic lanes will permit DPS to move traffic and relieve congestion.

Employ rear lights, flares, reflectors, or cones as required or as directed by the D.P.S. Traffic control and warning devices should be left to the D.P.S. whenever possible. Communicate with the D.P.S. whenever flammable liquid leaks, spills, etc., are present with regard to using flares.

Leave one crew member (usually the Engineer) to watch the traffic and set up warning devices until the D.P.S. arrives. Parking brakes are to be set, and the apparatus set with the wheels at an angle to the side.

- A. Consider parking above or below (on access frontage) if the traffic conditions are such that entry is impossible or difficult.
- B. A booster line or other hose line may be employed as a rope to ascend or descend to the freeway proper.
- C. Where the freeway is elevated, a ladder is an effective means to gain access and to effect evacuation from above
- D. Only the apparatus that is absolutely necessary shall be taken onto the freeway, under the direction of Command. The first due unit will proceed into the scene. All other units will stage off of the freeway (if possible) to await an assignment.
- E. Position apparatus in the emergency parking lane or on the shoulder, as far off the traffic lanes as possible.

PHOENIX REGIONAL
STANDARD OPERATING PROCEDURES

FREEWAY RESPONSE

M.P. 205.15

12/98-R

Page 5 of 8

- F. Do your job as rapidly as possible and then clear the traffic lanes.
- G. A ladder company spotted on the access frontage will usually provide the best method of advancing a line to elevated sections of the freeway.
- H. In sections of depressed roadway, it is faster to have a company above "drop" a line than one advanced up the slope.
- I. Several sections of the freeway have no access frontages and will require laying hose for long distances from on-ramps if a supply line is needed. Relay pumping and tenders should be considered in these cases.

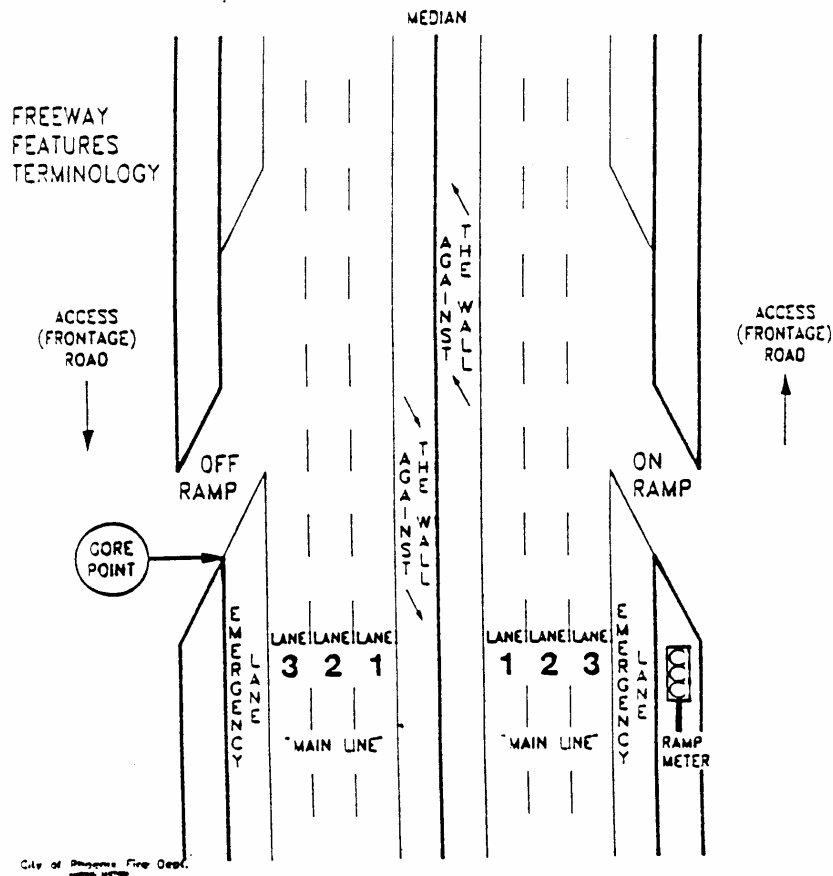

**PHOENIX REGIONAL
STANDARD OPERATING PROCEDURES**

FREEWAY RESPONSE

M.P. 205.15

12/98-R

Page 6 of 8

GLOSSARY

<i>TERM</i>	<i>DEFINITION</i>	<i>OTHER NAMES</i>
"Access Road"	Road parallel to freeway	"Frontage Road"
"Against the Wall"	Area around the median barrier wall	"Inside Shoulder" "Median Wall"
"The Curve"*	Usually refers to the I-17 Durango Curve; may also refer to the Broadway Curve on I-10 or the I-10 curve at Squaw Peak interchange	"Durango Curve"
"Distress Lane"	Usually refers to the area between the median barrier wall and the number one traffic lane; may also refer to the emergency lane	"Emergency Lane"
"Gore Point"	Area around freeway entrance and exit	"Gore"
"H.O.V. Lane"	High Occupancy Vehicle lane	"Car Pool Lane", "Bus Lane", or "Diamond Lane"
"Main lane"	Controlled access freeway	
"Mini-Stack"+	Squaw Peak interchange to I-10, SR-51 and Loop-202, near 20th Street and Roosevelt and McDowell Road	"Short Stack"+
"Shoulder"	Usually refers to the area off the roadway to the right of the emergency lane; may also refer to the median area near the left side of the roadway	
"The Split"	The Maricopa Interchange (I-10/I-17) traffic interchange west of the airport	
"The Stack"	The Papago (I-10)/Black Canyon (I-17) interchange, between 19th Avenue and 27th Avenue area	

**PHOENIX REGIONAL
STANDARD OPERATING PROCEDURES**

FREEWAY RESPONSE

M.P. 205.15

12/98-R

Page 7 of 8

GLOSSARY

<i>TERM</i>	<i>DEFINITION</i>	<i>OTHER NAMES</i>
"The Tunnel"	The portion of the Papago freeway (I-10) under Central Avenue, 3rd Street to 3rd Avenue.	"The Deck"
"Unified Command"	Command post consisting of more than one agency	

* Request specific location from reporting party.

+ Use of term discouraged.

Lane numbering sequence: No. 1 is the traffic lane nearest the median or center, excluding the H.O.V. lane.

PHOENIX METROPOLITAN FREEWAYS

<i>NAME</i>	<i>DESIGNATOR</i>	<i>LOCATION</i>
Black Canyon	Interstate 17	Begins at the Durango Curve and continues north through Phoenix
East Papago	Loop 202	Begins at I-10/SR-51/L-202/ interchange and continues east to the Price Freeway
Hohokam	State Route 143	Begins at I-10 and 48 Street and continues north to McDowell Road.
Maricopa	Portions of I-17	I-17 south (east) of the Durango Curve to the Maricopa Interchange and I-10 continuing east
Papago	Interstate 10	Entering Phoenix from the west to the Maricopa Interchange where it becomes the Maricopa Freeway
Squaw Peak	State Route 51	Begins at the I-10/-L-202/SR-51 interchange and continues north
Superstition	US 60	Begins at the I-10/US 60 interchange and continues east
Sky Harbor Expressway	State Route 153	Begins at University Dr. to Sky Harbor Blvd.
Agua Fria Freeway	Loop 101	Begins at I-17 and L-101 interchange and continues west/southwest to Glendale Ave.

PHOENIX REGIONAL
STANDARD OPERATING PROCEDURES

FREEWAY RESPONSE

M.P. 205.15

12/98-R

Page 8 of 8

Freeway Interchanges

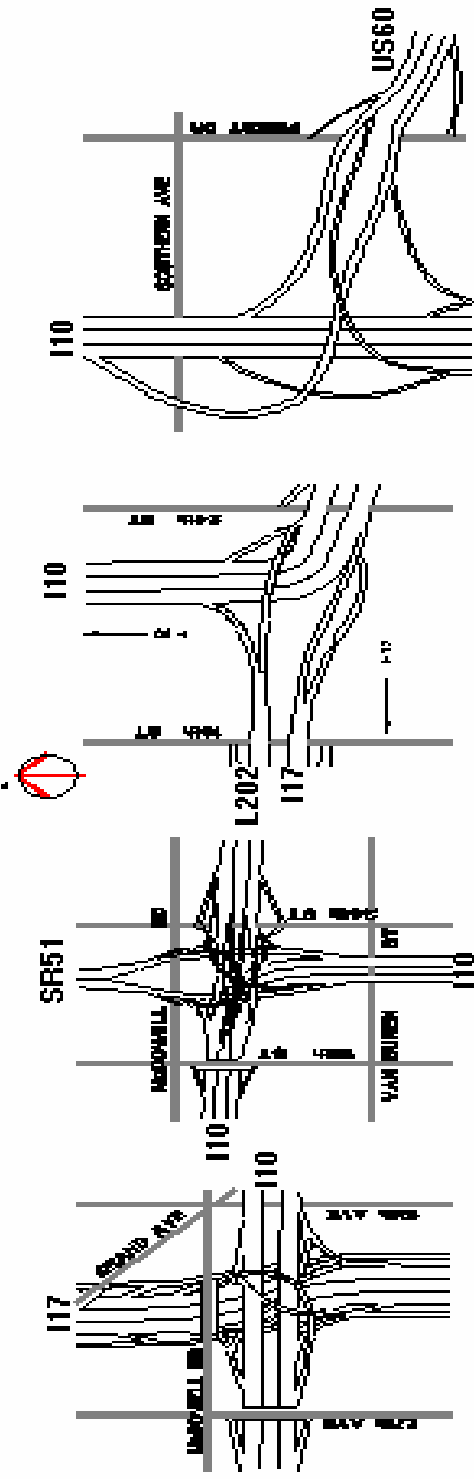

Stack

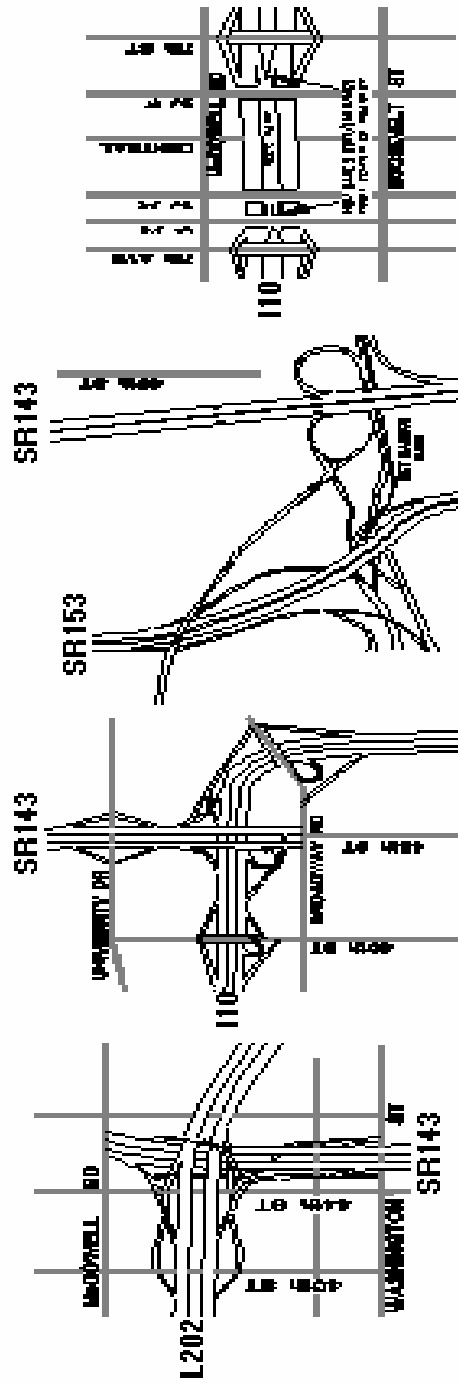

48th-Broadway Curve

Tunnel

**PHOENIX REGIONAL
STANDARD OPERATING PROCEDURES**

PAPAGO TUNNEL RESPONSE

M.P. 205.15A

04/17-R

04/22-SR

INTRODUCTION

The I-10 Papago Freeway Tunnel is located in Central Phoenix south of McDowell. The tunnel extends from Third Avenue to Third Street. The most direct access is off of Seventh Avenue and Seventh Street. There is no direct access to the tunnel from above (i.e., Margaret T. Hance Park).

VEHICULAR TUNNELS

There are two vehicular tunnels--eastbound vehicular, westbound vehicular. There are five lanes of traffic in each direction. Each vehicular tunnel also has two emergency lanes. The maximum volume of traffic is 8,000 autos/hour/tunnel.

BUS TRANSIT TUNNEL

There is a single Bus Transit Tunnel between the two vehicular tunnels to service bus traffic. This tunnel will not be in service for some time and has large fence gates at each end of the tunnel to restrict access. Gates will be large enough to allow fire apparatus to enter.

IT IS EXTREMELY DIFFICULT TO TURN FIRE APPARATUS AROUND IN THIS TUNNEL

Four access doors provide access from this transit tunnel to the vehicular tunnels (two on the eastbound side and two on the westbound side) and are located approximately one-third of the way in from the vehicular entrance/exit points.

VENTILATION

Each tunnel has mechanical ventilation. There are four ventilation rooms, two for each vehicular tunnel, that control air flow. Normal air flow is drawn into the tunnel near the middle and flows to exit points at either end of the tunnel. Air flow volume is determined by carbon monoxide readings. The higher the CO levels, the greater the air flow. The Bus Transit Tunnel does not have any mechanical ventilation.

Each vent room controls the following functions for one-quarter mile of its respective tunnel:

- Lighting
- Ventilation
- Fire Detection
- CO Monitoring

There is an Uninterrupted Power Supply (UPS) that provides "bare bones" bridging power between the loss of APS power and the start-up of the generator. Each vent room provides power, ventilation and fire detection control to a quadrant of the tunnel.

**PHOENIX REGIONAL
STANDARD OPERATING PROCEDURES**

PAPAGO TUNNEL RESPONSE

M.P. 205.15A

04/17-R

04/22-SR

Each vent room can be accessed from the surface via the structures at the park level. NOTE: These rooms have essentially one way in and one way out by means of a long stairwell. There are two separate levels to vent rooms 1-3 that go to a depth of nearly 40 feet below the surface (there is only one level to vent room 4).

WATER SUPPLY

- There are hydrant cabinets in the two vehicle tunnels located approximately every 300 feet on alternating sides of the tunnel (600 feet separation on the same side). Each cabinet has a 2 1/2" fitting and a 4" hydrant fitting.
- The hydrants are fed by 6" water mains.
- The location of the cabinets is indicated by a blue and white hydrant sign.
- The tunnel standpipe system is a wet system.
- A four-way fire department standpipe connection to support the wall hydrant system is located on Culver Street, 50' west of Central. Intake fittings on the connection is 2 ½ inch.

There is no water supply in the central Bus Transit Tunnel. Use of the emergency access doors one-third of the way in from the portals will allow access to the wall hydrants in the vehicular tunnels.

HUMAT VALVES WILL NOT FIT INTO THE HYDRANT BOXES IN THE VEHICLE TUNNELS. A DIRECT HOSE CONNECTION WILL BE REQUIRED. THERE IS NO WATER SUPPLY IN THE VENT ROOMS.

RADIO REPEATER SYSTEM

A radio repeater system has been installed in the tunnel to provide for communications. The following frequencies will operate in the tunnel:

- Fire Channels 1, 5, 8 (A-Deck)

Because of the approximate half-second time element needed to capture the repeater, the first part of a radio message can be lost. Companies should repeat their company identity twice at the front-end of the radio transmission to avoid loss of message (i.e., "Engine Four, Engine Four to Alarm").

EMERGENCY TELEPHONE CABINETS

There are emergency telephone cabinets located every 150 feet on both sides of the eastbound and westbound tunnels. The location of these cabinets is indicated by large reddish brown vertical stripes on the walls which are numbered 1 to 9 in the direction of traffic flow. Each cabinet is equipped with the following:

- An emergency telephone that is connected directly with the (Arizona Department of Transportation) ADOT Traffic Operations Center.
- A dry chemical fire extinguisher.

**PHOENIX REGIONAL
STANDARD OPERATING PROCEDURES**

PAPAGO TUNNEL RESPONSE

M.P. 205.15A

04/17-R

04/22-SR

- A fire alarm pull station.
- A security tamper switch to alert the operator when a cabinet is opened.

The emergency telephone is an intercom system that can be used as an alternative communication system as well as to talk to the ADOT Traffic Operations Center.

LIGHTING

Lighting in the freeway tunnels is on 24 hours and controlled by an automated system. There is lighting in the center Bus Transit Tunnel that can be turned on remotely or by a switch within the transit tunnel.

EMERGENCY POWER

There is one emergency diesel generator that supplies emergency power to the tunnel. There are Uninterrupted Power Supply (UPS) systems in each vent room that provide 15 minutes of bridge power between the loss of APS power and the start-up of the generator. The following systems are on emergency power:

- Limited lighting
- Fire Detection
- CO Monitoring

VIDEO CAMERA SYSTEM

A video monitoring system has been installed throughout the tunnel. There are cameras monitored at the ADOT Traffic Operations Center.

ALARM/DISPATCH

All emergencies detected by the ADOT Traffic Operations Center are reported to the Department of Public Safety (DPS), which is co-located within the ADOT Traffic Operations Center. The Department of Public Safety (DPS) will notify Phoenix Dispatch Center of all emergencies requiring a Fire Department response.

For serious incidents or conflicting information, Phoenix Dispatch Center should call the ADOT Traffic Operations Center to verify the situation. The ADOT Traffic Operations Center's video camera system can provide some additional information and adjustments to the dispatch can then be made.

RESPONSE AND OPERATIONS CONSIDERATIONS

Fire Department response to routine small-scale incidents should be routed through the most direct route, with the flow of traffic. The most direct access to the tunnel is off of Seventh Avenue and Seventh Street. The next most direct access is off of 19th Avenue and 16th Street.

**PHOENIX REGIONAL
STANDARD OPERATING PROCEDURES**

PAPAGO TUNNEL RESPONSE

M.P. 205.15A

04/17-R

04/22-SR

Significant emergencies requiring the dispatch of a 2-1 or larger should follow the following guidelines:

- The first due company should enter the freeway with the flow of traffic by the most direct route. This company must advise Dispatch and other units of traffic congestion and access to the incident, and redirect other companies as necessary to achieve a rapid arrival on the scene.
- If traffic congestion is severe; creating significant delays in reaching the incident site, the second due company should consider entering the Bus Transit Tunnel. This company should enter the freeway with the flow of traffic from the opposite direction. In order to safely reach the entrance to the Bus Transit Tunnel, companies must enter the freeway at either 16th Street or 19th Avenue. The entrance to the Bus Transit Tunnel is located in the middle between the two freeway tunnels. Companies approaching the tunnel should ease towards the median lane in order to enter the Bus Transit Tunnel. The fence gate must be opened to enter. Once in the tunnel, this company can go to one of the emergency access doors located approximately 1/3 of the way into the tunnel to gain access to the incident site.
- The first Chief Officer should respond to the incident site with the flow of traffic, or as otherwise directed by the first due company and traffic coordinators.
- Considerer sending a Chief Officer to the ADOT Traffic Operations Center to provide liaison for the Incident Command.
- A 2-1 or larger will have two Battalion Chiefs assigned.

STAGING

Other companies should Level II Stage on Culver Street, just west of Central (the tunnels hydrant system standpipe connection is located there). The first due company or Command may opt to re-direct these companies to a staging location on the freeway or directly to the tunnel as needed.

INCIDENT COMMAND

Phoenix Fire Department Standard Operating Procedures and Incident Management System will be utilized for any emergencies in the tunnel. The Command Post will utilize a Unified Command with other affected agencies represented at the incident. The Incident Commander must notify Dispatch of the Command Post location as soon as it is established.

Major Incidents/Tactical Considerations

There are four probable major incident scenarios for an emergency in the tunnel, and they are listed below.

1. Major Medical

- Access to patients may be severely limited. Access will be from each end of the incident rather than all four sides.
- Secure access against traffic flow. **DPS MUST STOP ALL TRAFFIC ENTERING THE FREEWAY AT SEVENTH STREET AND SEVENTH AVENUES.**
- A DPS liaison must be requested to the Command Post as early as possible.

**PHOENIX REGIONAL
STANDARD OPERATING PROCEDURES**

PAPAGO TUNNEL RESPONSE

M.P. 205.15A

04/17-R

04/22-SR

- Move apparatus staging to the freeway entry point or tunnel as appropriate.
- Watch for moving traffic.
- Because of possible restricted access around the sides of a major incident, two or more Treatment Sectors may be required.
- Have the ADOT Traffic Operations Center increase the lighting in the tunnel as necessary.
- Have ADOT adjust the exhaust fans' direction and volume as needed.
- A hazardous materials problem may exist--ruptured fuel tanks or truck cargo (see Haz Mat Incidents).
- A fire may be present (see Fire Incident).
- Protective hoselines may be required.
- Additional personnel may be needed to move and carry patients over and around vehicles and debris for some distance.

2. Major Fire

- Access with the flow of traffic may be severely restricted.
- Confirm exact location of the incident with the ADOT Traffic Operations Center.
- Route crews from opposite direction into Bus Transit Tunnel, and against traffic WHEN SAFE TO DO SO and as needed to access the incident site.
- Have DPS stop traffic so that emergency vehicles can enter against traffic.
- Confirm with the ADOT Operations Room that the exhaust fans are working at maximum volume and in the direction needed to control the tunnel environment.
- Confirm with ADOT that the sump pump system is turned off.
- Confirm the lighting system is on maximum.
- Consider surface wind direction and speed in the approach and positioning of the fire apparatus. Wind direction may make a down wind approach impossible.
- SCBA's must be donned prior to entry with evidence of a working fire in the tunnel.
- Victims caught in traffic congestion will need rescue and escorting out of the tunnel.
- The Bus Transit Tunnel should be checked for victims using the emergency access doors to evacuate.
- Apparatus should be located uphill from the drain system to avoid runoff exposure.
- Ensure adequate foam capacity is on scene before initiating a foam attack.
- First attack lines should protect victims and rescuers.
- Second attack lines should address fire control and extinguishment.
- Because of extensive debris and limited access to the seat of the fire, stang guns may prove effective for reach and knockdown.
- Address runoff as a hazardous materials contamination and control/seal/dike freeway drains.
- Consider air contamination and evacuation needs of the neighborhood around the tunnel and Margaret T. Hance Park.

**PHOENIX REGIONAL
STANDARD OPERATING PROCEDURES**

PAPAGO TUNNEL RESPONSE

M.P. 205.15A

04/17-R

04/22-SR

- Assign an engine company to pump the tunnel's hydrant standpipe system located on Culver Street West of Central.
- Utility company lighting in the tunnel may be required as the fire/heat will damage the tunnel's lighting system.
- Move Level II Staging to the freeway near the tunnel if appropriate.
- The Bus Transit Tunnel may serve as an alternate attack/access point via the emergency access doors. No water supply is available in the Bus Transit Tunnel but can be obtained by hand-jacking a supply line through an access door to a wall hydrant in one of the vehicular tunnels.
- Positive pressure ventilation may be needed at the transit access doors to prevent smoke passage.
- The Bus Transit Tunnel may also serve as a Rehab location and Resource Sector operation. A utility company will be needed for lighting and Rehab operations.
- The incident may be deep within a contaminated atmosphere. Crews may run out of SCBA air by walking in. A taxi/shuttle system should be considered or use of the Bus Transit Tunnel as a safe refuge.
- The Command Post may need to be established outside of the tunnel to ensure adequate Command-to-Dispatch communications.
- Strict lobby control and personnel accountability must be maintained.

Sectors to consider for a major fire incident include:

- Lobby Sector(s)
- East and West Sectors
- Haz Mat Sector
- De Con Sector
- Bus Transit Tunnel Sector
- Resource Sector
- Rehab Sector
- ADOT Traffic Operations Center (Liaison Sector)
- Staging Sector
- Extrication Sector
- Treatment Sector
- Transportation Sector
- Police/DPS Liaison Sector
- Safety Sector
- Accountability Sector(s)
- Public Information Sector (coordinated with, ADOT and DPS)

**PHOENIX REGIONAL
STANDARD OPERATING PROCEDURES**

PAPAGO TUNNEL RESPONSE

M.P. 205.15A

04/17-R

04/22-SR

3. Hazardous Materials Spill/Release

- Access with the flow of traffic may be severely restricted.
- Confirm exact location with ADOT Traffic Operations Center.
- Route crews from opposite direction, Bus Transit Tunnel, and against traffic WHEN SAFE TO DO SO and as needed to access incident site.
- Confirm with ADOT that the exhaust fans are working at maximum volume and in the direction needed to control the tunnel's environment.
- Confirm with ADOT that the sump pumps are shut down.
- Confirm with ADOT that lighting is at maximum.
- SCBA's must be donned prior to entry into the tunnel with evidence of a hazardous materials spill or release.
- Initiate diking of drain systems as needed to control runoff.
- Consider surface wind direction and speed as a factor in the apparatus and attack positioning.
- Apparatus should be located uphill of the drain to avoid runoff contamination.
- Address victim rescues and escorting of tunnel wounded out of the tunnel or to safe refuge in the Bus Transit Tunnel.
- Address search-and-rescue of Bus Transit Tunnel for any victims who used emergency access doors to seek safe refuge.
- Consider air contamination of the tunnel, Margaret T. Hance Park, and neighborhood.
- Address area evacuation as required.
- Upwind Level II Staging on the freeway may be appropriate.
- The Bus Transit Tunnel may serve as a safe refuge, rehab, resource, and main attack point.
- Positive pressure of the Bus Transit Tunnel access door may be required to protect the transit tunnel refuge area from contamination.
- Utility company lighting will be required in the Bus Transit Tunnel.
- The incident depth within the tunnel may not permit adequate SCBA airtime to reach the incident. A vehicle shuttle (taxi) or use of the Bus Transit Tunnel to access the incident should be considered.
- The Command Post may need to be established outside the tunnel and in a safe location.
- Strict lobby control and personnel accountability must be maintained.

Sectors to Consider for a Major Hazardous Materials Incident:

- Lobby Sector
- East and West Sectors
- Haz Mat Sector
- De Con Sector
- Bus Transit Tunnel Sector
- Resource Sector
- Rehab Sector

**PHOENIX REGIONAL
STANDARD OPERATING PROCEDURES**

PAPAGO TUNNEL RESPONSE

M.P. 205.15A

04/17-R

04/22-SR

- ADOT Traffic Operations Center (Liaison Sector)
- Staging Sector
- Police/DPS Liaison Sector
- Safety Sector
- Accountability Sector
- Public Information Sector (coordinated with, ADOT and DPS)

4. Below Ground Fire

There are five below-ground facilities related to the tunnel operations. Four of the facilities are for ventilation fan room operations. The fifth facility is the power and equipment room (Central Avenue). Each of the facilities have multiple levels and go down nearly 40 feet below grade. SCBA's must be worn.

A fire in one of these below-grade facilities poses extreme risk to rescuers or firefighters. Smoke, lack of lighting, multiple levels, and staircases all increase the risk. Such events should be considered as confined space operations and appropriate procedures applied (MP 205.09 Confined Space Rescue).

If persons are reported trapped, consider their survival profile (utilizing the risk management system) before committing rescue operations. Apply all safety systems as required and proceed cautiously.

If no persons are believed trapped, or the survival profile suggests no rescue should be attempted, the best approach may be to seal the facility, secure all power, and let the fire burn itself out. Use of inert gas may be considered to extinguish the fire.

Once the fire is extinguished, adequate ventilation, lighting and air sampling should be completed prior to entry. Entry will be considered a confined space rescue requiring all appropriate safety procedures.

COMMUNICATIONS FAILURE

As indicated, the tunnel has radio repeater systems for fire channels 1, 5, and 8 (A-Deck). Should the assigned channel repeater fail, on-site radio communications should be switched to the other tactical radio channel (e.g., channel 5 fails, crews go to channel 8). Should all systems fail, Command must establish a communications relay Company (or Sector) to provide a communications link to Dispatch that is located outside the tunnel.

**PHOENIX REGIONAL
STANDARD OPERATING PROCEDURES**

DISTRICT VAN RESPONSE

M.P. 205.16

09/00-R

Page 1 of 3

Policy Statement

It is the policy of the Phoenix Regional Department to provide assistance to people involved in emergency incidents who may not need emergency medical care but still need support to recover from the situation.

Purpose

The goal of the District Van Volunteer Program is to provide assistance for non-emergency activities; to provide an alternate means of transporting family members not requiring standard ambulance transportation, and other assistance to the public.

The District Van may also be utilized to assist fire companies in retrieving medical equipment and paramedics from hospitals.

Operating Hours

The District Van will be staffed by fire cadets or trained volunteers. Hours of service may vary according to the availability of volunteer personnel and the hours they may be available to work.

The District Van will notify the Dispatch Center as they go in service for the day, and as they go out of service at the end of each shift. The Service Van will assume the radio identity of "-District Van-5," followed by their assignment (i.e., District Van-5).

Dispatch

The District Van can only be dispatched following the request of a fire department member, who is on the scene. The District Van is a non-emergency vehicle and will respond Code 2.

If an incident number has not yet been assigned to the request, Dispatch will assign an incident number and will log times of dispatch, arrival, departure and destination arrival. The District Van will acknowledge response and report/announce on scene, departure and destination arrival times via radio or MDT.

Transportation Eligibility

To be eligible for transportation by the District Van, one of the following criteria must be met:

- People with no apparent injuries, requiring no medical treatment by the fire department.
- Family members of patients desiring transport to hospitals to be with injured or ill family members (i.e., auto accident, family at hospital, family member has completed the police reports and needs ride to hospital).

The District Van will not be available to transport:

- LARC customers.
- Drunk or Disorderly customers.

**PHOENIX REGIONAL
STANDARD OPERATING PROCEDURES**

DISTRICT VAN RESPONSE

M.P. 205.16

09/00-R

Page 2 of 3

- Psychotic Customers.
- Any person who may become hostile while en-route.

The District Van Transport Form must be completed on each transport.

Other Types of Services Provided

The District Van may be utilized to provide the following services for fire department Personnel:

- Picking up paramedics from hospital in the designated service area and returning them to their assigned companies.
- Retrieving medical equipment (i.e. MAST suits, traction splints, etc.) from hospitals in the designated area and returning the equipment to the companies.
- Assisting Resource Management and on-duty engineer in the delivery of equipment to the companies.
- Assist fire department Vehicles with battery jumper service upon request.
- Transport paperwork and/or equipment.

Citizen Assist

The District Van will also provide other public service, such as:

- Provide a cellular phone to contact other family members, tow trucks, other assistance or agencies.
- Battery jumper service for Private Vehicles when stranded.

Supervision

The District Van volunteers will be supervised by:

- The Captain at the station at which the District Van is housed.
- The Company Officer on the incident scene.
- EMT coordinator of the Community Assistance Program.

The Program Manager will monitor the program.

Safety

All applicable safety procedures and practices will apply. Seat belts shall be worn by all passengers. An infant car seat will be provided to secure infant/child passengers. Safe parking, use of emergency lighting when parked in traffic, and the wearing of safety vests will be required. Smoking will not be permitted in the District Van.

**PHOENIX REGIONAL
STANDARD OPERATING PROCEDURES**

DISTRICT VAN RESPONSE

M.P. 205.16

09/00-R

Page 3 of 3

Customer Relations

The primary objective of the District Van is to provide good customer service to the public and members of the fire department. The District Van provides unique services to the public; transportation, use of the District Van's cellular phone to call for assistance, and other services that can provide a very positive relationship with the public. Fire department members should make every effort to make this service available whenever it is reasonable and safe to do so.

DISTRICT VAN TRANSPORT

1. Inc. # _____ Date _____
2. Capt. (Print clearly) _____
3. Company I.D. _____
4. Customer Name _____
5. Transport to _____
6. Reason for transport _____

7. Is customer injured or ill in any way? Yes No
8. If customer is injured, describe why you feel an ambulance transport is not necessary.

The District Van is a volunteer activity, conducted by members of the P.F.D. Cadet Program to assist citizens in need. District Van transportation is not an alternate to an ambulance transport and shall not be used as such.

I understand the procedures for proper use of the District Van and feel this particular incident is an appropriate use of the District Van.

Captain's Signature

**PHOENIX REGIONAL
STANDARD OPERATING PROCEDURES**

Mutual Aid Response and Operations

M.P. 205.17

05/18

Page 1 of 3

Purpose

The purpose of this procedure is to provide Mutual Aid assistance to fires, medical emergencies, hazardous materials incidents, technical rescues and other types of emergency incidents that are within the scope of services provided by fire departments.

Definitions

Mutual Aid is defined as, any Fire Department emergency response and/or incident mitigation assistance provided by one jurisdiction to other jurisdictions when no formal Automatic Aid agreement has been instituted. Any Mutual Aid assistance provided will be the result of a formal request for assistance from one jurisdiction to the other jurisdiction.

Authority

When Mutual Aid assistance is provided, the Authority Having Jurisdiction (AHJ) remains ultimately responsible for the incident and must provide incident support.

Procedure

It is understood that a jurisdiction or area outside of the Regional Metropolitan Phoenix Automatic Aid Response System may exceed their response capabilities. When the Fire Chief or their designee determines that assistance is needed to mitigate an emergency incident within their jurisdiction, a request for assistance can be made to either party of this agreement. When a request for assistance is made, the following process must be followed:

1. The requesting jurisdiction will contact Dispatch and Deployment to request assistance. The request must include the type of incident, the type and number of resources being requested, current number of resources assigned to the emergency incident, and the current Incident Action Plan(IAP) being utilized.
2. Upon receipt of the information, Dispatch and Deployment staff will determine the closest appropriate supporting jurisdiction to fulfill the request. Upon that determination, Dispatch and Deployment will contact the on-duty Shift Commander or Battalion Chief of the proposed supporting jurisdiction to obtain approval to dispatch requested resources.
3. The following criteria will be utilized by the Fire Chief or their designee to determine the level of support that will be provided:
 - A. What is the incident type and nature?
 - B. What is the immediate or foreseeable Life Hazard?
 - C. Has the responsible agency dispatched resources to the incident? If so, what is their estimated time of arrival to the incident.
 - D. Is a different jurisdiction closer that can provide the requested support? If so, refer the request to that jurisdiction.

**PHOENIX REGIONAL
STANDARD OPERATING PROCEDURES**

Mutual Aid Response and Operations

M.P. 205.17

05/18

Page 2 of 3

- E. Is the requested support appropriate to ensure scene safety, and to operate within the Phoenix Fire Departments Volume 2 procedures? If no, what resources would be needed?
 - F. What is the current overall resource availability of the jurisdiction being requested? What impact will the fulfillment of the request have on the system?
4. After thoroughly assessing the above criteria, the Shift Commander or Battalion Chief will make a determination to fully support, partially support, or deny the Mutual Aid request. Upon this determination, the supporting jurisdictions Shift Commander or Battalion Chief will advise Dispatch and Deployment of the level of response that will be provided.
 5. If assistance will be provided, Dispatch and Deployment will immediately dispatch the determined resources, and notify the requesting jurisdiction of the status of their request for assistance.

Exceptions

- This procedure does not govern Statewide Mutual Aid requests or the deployment of the Rapid Response Task Force.
- Enhanced Mutual Aid with Rural/Metro Fire Department (RMFD) within one (1) mile of the borders of Scottsdale and Phoenix in the Northeast portion of the Valley. Rural/Metro units and Automatic Aid Consortium units can be dispatched into these areas without prior approval when the Computer Aided Dispatch (CAD) system recognizes a RMFD unit is closer in these areas.
- Enhanced mutual aid for requests by Gila River Indian Community Fire Department for incidents that occur on Interstate 10 from Phoenix city limits to Mile Post 169; within two and one-half (2.5) miles from the border of the Gila River Indian Community and the cities of Chandler and Phoenix in Maricopa County; within one (1) mile of the border of the Gila River Indian Community, the City of Chandler, and the Sun Lakes Fire Districts in Pinal County.
- One (1) way Automatic Aid onto Luke Air Force Base (LAFB); CAD has been programmed to select LAFB units for any calls that fall within a five (5) mile radius of the base. CAD will also select the next available unit to respond.

**PHOENIX REGIONAL
STANDARD OPERATING PROCEDURES**

Mutual Aid Response and Operations

M.P. 205.17

05/18

Page 3 of 3

Parameters for On-Site Operations by Assisting Jurisdictions

1. Mutual Aid units will use every effort to support the on-site Incident Commander in a positive manner.
2. Assisting resources will always operate under an Incident Command System (ICS).
3. Interoperable communications must be available. Crews will not operate in any hazardous environment without uninterrupted communications.
4. Assisting resources must follow the Phoenix Fire Department's Volume 2 procedures.
5. The first arriving Company/Command Officer from the assisting resources will establish communications with the Incident Commander. If there is no command structure established, the first arriving Company/Command Officer will facilitate the implementation of an ICS utilizing a Unified Command with the AHJ. Implementation will include the appropriate sectors, branches, and sections as needed. If the AHJ is unable to support a Unified Command Structure assisting resources will establish an ICS.
6. Company/Command Officers will use the Strategic Decision Making Model to determine the safety of the situation, the Mutual Aid Incident Commander's Incident Action Plan, and will proceed only if it is determined safe to do so. If unsafe to proceed, fire companies will advise the Incident Commander of their concerns while adopting an appropriate Incident Action Plan.
7. Fire companies will operate with intact crews. Incidents declared Offensive in nature will be mitigated with a minimum of two Engines. Crews and personnel will not be separated.
8. Ladder companies are a limited resource, and unable to negotiate unpaved roads. Therefore, Command Officers should consider whether a Ladder Company response is justified.
9. Command shall maintain a communications link with Dispatch and Deployment. The emergency traffic notification will be made available for use by Automatic Aid Companies as well as elapsed time notifications when appropriate.
10. Breathing apparatus will be refilled by Utility Trucks from Automatic Aid cities only.
11. Injured or ill Firefighters will be transported by fire department operated Ambulances whenever possible.
12. The Command Officer will update Dispatch and Deployment with progress reports upon arrival, and at appropriate points throughout the incident. When appropriate, the Assistant or Deputy Chief of Operations and Dispatch and Deployment will be given updates of the incident.
13. Assisting resources will be released from the incident as soon as conditions warrant, or the local jurisdiction has arrived and is ready to act. A necessary transfer of information will then occur. All overhaul operations will be completed by the requesting jurisdiction.

**PHOENIX REGIONAL
STANDARD OPERATING PROCEDURES**

ASSISTING OTHER AGENCIES

M.P. 205.18

03/09-R

Page 1 of 2

PURPOSE

The purpose of this management procedure is to document fire department response when agencies request assistance where hazardous materials, wastes, or substances may be present, e.g. search warrants.

The Phoenix Fire Department Special Operations Section has available multiple specially trained air scent dogs able to search disaster sites, urban settings, and rural areas for live victims that may be trapped and/or missing. These dogs are assigned to Phoenix Fire Department Canine Search Specialists and available to assist other agencies in locating missing non-violent adults and children.

A canine search specialist team for non USAR call outs will consist of two handlers, two canines, two PFD members as support personnel familiar with safety procedures, mapping, GPS, compass, canine search procedures, and sector operations, and a Phx PD or other sponsoring agency Liaison Officer.

DEFINITION

The term "agency/ies" includes, but is not limited to: The Phoenix Police Department, The Maricopa County Sheriff's Department, Arizona Department of Environmental Quality, the State of Arizona Attorney General's Office, and any other law enforcement agency.

POLICY

It is the policy of the Phoenix Fire Department to provide limited support to other agencies, when requested, at sites of search warrants and searches for missing/lost non violent persons. Support may consist of, but is not limited to: code enforcement, providing research and information on specific hazardous material, and decontamination of entry personnel. At no time will any Phoenix Fire Department canine search specialist teams and support personnel be used to conduct search operations involving criminal or violent subjects.

REQUEST FOR ASSISTANCE FROM URBAN SERVICES/TRT UNITS

Any agency requesting assistance from on-duty Special Operations personnel and/or the TRT units shall contact the Dispatch Supervisor at (602)262-7496.

A pre-incident meeting shall be scheduled between the requesting agency and the Special Operations Duty Officer. The agency that is requesting the assistance shall provide information on location(s), time(s), staging area(s), type(s) of products that may be involved, and the type of assistance that is needed. Based upon the information disseminated, the Special Operations Duty Officer may elect to have TRT units respond as a precautionary measure. Security of information will be strictly adhered to.

The Special Operations Chief, Shift Commander and Battalion Chief shall be notified. The Special Operations Duty Officer will initiate such notification. Security of information will be strictly adhered to.

The Special Operations Duty Officer may elect to have the on-duty Fire Prevention Specialist respond to the site for documentation purposes.

**PHOENIX REGIONAL
STANDARD OPERATING PROCEDURES**

ASSISTING OTHER AGENCIES

M.P. 205.18

03/09-R

Page 2 of 2

REQUEST FOR ASSISTANCE FROM URBAN SERVICES/CANINE SEARCH SPECIALIST TEAMS

Any agency requesting assistance from Special Operations canine search specialist teams shall contact the Dispatch Supervisor at (602)262-7496. Call out by the Dispatch Supervisor will be made through the on duty Special Operations Chief.

DISPATCH ROOM NOTIFICATION

When deemed appropriate, the on-duty Fire Prevention Specialist or the Special Operations Duty Officer may notify Dispatch via telephone of the Agency request for assistance. An active incident number will be requested when Operations personnel or equipment are required at the site. The dispatch shall be "Assist Agency".

HEALTH AND SAFETY

No personnel shall enter a hazardous material, waste, or substance area without appropriate protective clothing and equipment.

Personnel showing any signs or symptoms of a chemical exposure during or after the administration of a search warrant shall be transported to Banner Good Samaritain, providing that the exposure is not a critical life threatening emergency. Critical life threatening injuries require transport to the closest appropriate hospital. All potentially exposed personnel and equipment shall be decontaminated. All potentially exposed fire department personnel shall complete a Hazardous Materials Exposure Report Form. Exposed equipment, especially protective clothing, may have to be properly disposed of. Notification of Health and Fitness Deputy, Exposure Control Officer, and Safety Officer shall be made.

ENTRY

Phoenix Fire Department personnel will not participate in an entry operation unless:

- (1) An emergency situation develops involving hazardous materials, wastes, or substances.
- (2) The safety of the Phoenix Fire Department personnel is not jeopardized.
- (3) A representative from the Arizona Department of Environmental Quality Emergency Response Unit is present.

Phoenix Fire Department personnel shall not make entry into the search warrant site until the appropriate law enforcement agency has deemed the site secured and "safe".

DOCUMENTATION

The on-duty Fire Prevention Specialist shall submit all reports generated as the result of the search warrant to the appropriate law enforcement agency.

**PHOENIX REGIONAL
STANDARD OPERATING PROCEDURES**

**WATER DEPARTMENT COMMUNICATIONS
HAZARDOUS MATERIALS INCIDENTS**

M.P. 205.19

03/00-R

Page 1 of 2

PURPOSE

The purpose of this procedure is to document Water Department notification relating to fire and non-fire incidents involving hazardous materials.

The Water Department has requested that they be included in the Fire Department's incident notification procedure to ensure that, when required, backflow devices are installed on public or private fire hydrants, hose bibs, etc. to prevent water main contamination.

SCOPE

This procedure shall apply to, but is not limited to the following operations:

- Decontamination operations by other than Fire Department personnel;
- Clean-up operations; and
- Rinsing of containers

This procedure shall not apply to Fire Department activities conducted to mitigate an emergency, overhaul operations, or decontamination activities conducted by Fire Department personnel.

ARIZONA DEPARTMENT OF ENVIRONMENTAL QUALITY (A.D.E.Q) RESPONSIBILITIES

When an incident occurs that involves hazardous materials, A.D.E.Q. will require appropriate clean-up procedures be conducted by either the incident business personnel or a hazardous waste contractor.

FIRE DEPARTMENT RESPONSIBILITIES

When it is determined that a clean-up operation may involve the use of a public or private fire hydrant, a hose bib, etc., a Fire Prevention Specialist shall call the Water Department's 24-hour number, 261-8000, and submit the following information to the dispatcher:

1. Fire Department representative's name.
2. Incident business name.
3. Address of incident.
4. Reason for notification (e.g., a hazardous materials incident has occurred that requires clean-up).
5. Name of business responsible party.
6. Telephone number of business responsible party.
7. Name of hazardous waste contractor, if available.
8. Telephone number of hazardous waste contractor.
9. Routing for Water Department to site.
10. Action requested by Water Department (e.g., a foreman or supervisor with Water Distribution is requested to respond).

If the Fire Prevention Specialist is unsure of how clean-up operations will be conducted, the Water Department shall be notified as an advisory only and submitting Items 1 through 8 to the dispatcher.

PHOENIX REGIONAL
STANDARD OPERATING PROCEDURES

WATER DEPARTMENT COMMUNICATIONS
HAZARDOUS MATERIALS INCIDENTS

M.P. 205.19

03/00-R

Page 2 of 2

FIRE DEPARTMENT HAZARDOUS MATERIALS INCIDENT NOTIFICATION
TO THE WATER DEPARTMENT

Water Department Dispatcher: 261-8000 (24-Hours)

When it is determined that a hazardous materials incident could involve a clean-up operation, the Water Department has requested notification. As a result, the following information shall be submitted to the Water Department Dispatcher:

(Mark appropriate answer:)

Clean-up IS ___MAY BE ___ required which may involve the use of a
FIRE HYDRANT ___ HOSE BIB ___ or BOTH ___.

INCIDENT INFORMATION

(Fill in the blanks:)

- Notification

Made by (Name) _____

Notification Made by Telephone ___ FAX ___ Both

- Incident Address _____

Commercial ___ Residence

- On-Site

Responsible Party (R.P.) _____

R.P. Telephone Number _____

- Hazardous Waste Contractor _____

Contractor Telephone Number _____

- Fire Department

On-Scene Contact Person _____

- Recommended

Routing to Site _____

- Action Requested _____

- Additional Info _____

**PHOENIX REGIONAL
STANDARD OPERATING PROCEDURES**

RESPONSE TO POWER LINES/ENERGIZED ELECTRICAL EQUIPMENT

M.P. 205.20

03/09-R

Page 1 of 2

It is our policy to respond to reports of power lines down and other hazards involving energized electrical equipment (transformers, substations, electric vaults) for fire control and public safety. It is the responsibility of the company officer to maintain that level of safety until relieved by another fire company, police agency or utility company.

PURPOSE

This procedure will establish a standard approach and response to the report of power lines down and other responses to energized electrical equipment. Power lines can come in contact with the ground as a result of storm related activity, fire, or vehicles striking power poles. In all cases, the potential for electrical shock/electrocution and secondary fire must be considered.

ELECTRIC SAFETY AWARENESS

Electricity will travel any conductive path it can as it seeks a ground. A direct path to ground can occur when contact is made between something energized and a portion of your body such as your hand, arm, head, or other body part. An indirect path to ground occurs when you are holding something or touching an object that is in contact with something energized. This could include tools or other equipment you may be holding or when touching a fence, vehicle, or other object that may be in contact with something energized.

Gradient Voltage (Step and Touch Potential)

When power lines are down, they will energize the ground around them. For Example: point of ground contact could be 7160 volts. This voltage will lessen as it radiates out from this point; for example, 6000 volts. If your feet are in areas where there is a voltage difference, you could complete the circuit and be the source to ground. This is called "step potential." This danger could be indicated by a tingling sensation in the feet and serve as a warning to back away from the area. Step potential is more severe when the ground is wet.

Key Points

- Downed lines must always be considered energized with potentially lethal current.
- Lines can reset and become "hot" or "energized" again by manual operation of a switch, by automatic re-closing methods (either method from short or long distances away), by induction where a de-energized line can become hot if it's near an energized line, or through back feed conditions.
- Power line tends to have "Reel Memory" and may curl back or roll on itself when down.
- Use caution when spraying water on or around energized electrical equipment. Hose streams conduct current! Never spray directly into the power lines. Use a fog spray at the base of the pole. Your primary responsibility is to protect the surrounding area. Short bursts of water are preferred methods to avoid being grounded. Never spray water onto electrical equipment until a utility rep has confirmed that the equipment is de-energized or "dead."
- Electrical equipment is classified as:
 - Energized
 - De-energized (cannot be 100% guaranteed)
 - Dead (confirmed by utility representatives after grounding the lines(s)).
- PCB hazards: Smoke potentially fatal; avoid and contain pools of oil around transformers.
- Poor soil resistance in the desert southwest may not provide enough of a ground to trip a circuit even when a conductor is laying on it.
- You cannot tell the voltage of a power line by the size of the conductor. Most overhead conductors are not insulated.

**PHOENIX REGIONAL
STANDARD OPERATING PROCEDURES**

RESPONSE TO POWER LINES/ENERGIZED ELECTRICAL EQUIPMENT

M.P. 205.20

03/09-R

Page 2 of 2

- Voltage can travel through both dry and especially wet ground for considerable distances.
- Pad-mounted and overhead transformers can explode.
- Until grounded, equipment can contain electric potential, which can cause severe injury or death.
- Electricity can flow through the ground or other conductive objects, (fences) to point far from the scene.

RESPONSE TO POWER LINES DOWN

- Request utility company to respond.
- Consider all down wires as “energized.”
- Place apparatus away from “down lines and power poles” and out from under involved overhead lines that could fail and fall onto equipment or personnel.
- Secure the area/deny entry.
- Periods of high activity; company officer may choose to leave one (1) crewmember on-scene with a radio to wait for utility company.
- In the event of multiple lines/poles down over a large area, call additional resources.

Down Power Lines and Vehicles

- Request utility company to respond.
- Do not touch vehicle
- Have occupants remain inside the vehicle
- Place apparatus a safe distance away from down lines.
- If occupants must leave the vehicle (fire or other threat to life) instruct them to open the door, not step-out! They should jump free of the vehicle without touching vehicle and ground at the same time; they should walk away from the vehicle with very small steps.

SUB-STATION, TRANSFORMER, ELECTRICAL VAULT AND MANHOLE FIRE

- Request utility company to respond.
- Clear the area.
- Be aware of explosion potential.
- Place apparatus in a safe location away from overhead power lines.
- Protect exposures.
- Do not make entry until the utility representative has verified that the above electrical equipment has been de-energized. The utility representative may have to make entry to uninvolved sections to safely de-energize the equipment.

RESPONSE TO POWER POLE FIRES

- Request utility company to respond.
- Consider all wires and poles as “energized.”
- Place apparatus away from “down lines and power poles” and out from under involved overhead lines that could fail and fall onto equipment or personnel.
- Secure the area/deny entry.
- Do not make any fire attack until the utility representative has verified that the electrical equipment has been de-energized.

**PHOENIX REGIONAL
STANDARD OPERATING PROCEDURES**

BATTERY ENERGY STORAGE SYSTEMS

M.P. 205.20A

10/19-N

Page 1 of 2

Battery energy storage systems (BESS) pose unique hazards to firefighters. With recent advances in battery technology and renewable energy, lithium-ion batteries have become one of the leading solutions for large-scale energy storage. Buildings or facilities containing a BESS may not have markings that specifically identify the presence of these systems. Markings may only indicate a general electrical hazard is present. An independent facility containing a BESS may appear to be a steel building resembling a conex box. These facilities may be found anywhere or incorporated in another structure, including residential.

The types of catastrophic failures that can occur in all battery systems are amplified by the size and scale of BESS. The hazards are dependent on the design of the BESS, characteristics of the compartments containing the BESS, and levels of fire protection systems in the structure.

In smaller residential settings, a lithium-ion battery module may undergo thermal runaway as a result of exposure to a heat source unrelated to the battery. For example, a battery module located in or near a garage is exposed to a car fire can liberate toxic and flammable gases and present extinguishment problems.

BESS failures can occur for a variety of reasons including but not limited to:

1. Thermal abuse (external temperatures)
2. Physical/mechanical damage
3. Electrical abuse (over-charging or repeated excessive charging rates)
4. Environmental impacts (electrical surge, lighting, etc.)
5. Internal faults within the battery cell
6. Other electrical faults or system failures

In addition, stranded energy or remaining energy is an important factor regarding a BESS incident. Residual energy within a damaged lithium-ion battery or BESS presents a significant fire, shock, and/or explosion hazard to firefighters.

RESPONSE TO BATTERY ENERGY STORAGE SYSTEMS

- BESS must always be considered energized. Firefighters should exercise extreme caution when dealing with BESS and all energized electrical equipment.
- Request utility company to respond.
- Request a 3&1 or greater hazardous materials response.
- **Do not make entry or approach BESS building or compartment.**
 - The exception to this is a savable life/known rescue.
- Clear the area. Recommended initial evacuation distance is 150 feet.
- **Be aware of explosion potential and off-gassing of hazardous materials. White colored smoke is a good indication of hazardous off-gassing.**
- Place apparatus in a safe location away from BESS and overhead power lines.
- Protect exposures.

**PHOENIX REGIONAL
STANDARD OPERATING PROCEDURES**

BATTERY ENERGY STORAGE SYSTEMS

M.P. 205.20A

10/19-N

Page 2 of 2

- The Incident Commander will make the ultimate determination regarding hazard mitigation. The hazard mitigation plan should be developed in partnership with the utility representative and/or responsible party.
 - Through this careful approach, hazardous materials technicians may take calculated steps to mitigate that hazard.
 - Depending on the BESS type and size, mitigation steps may include identification of the hazard, separating from electrical supply (i.e., electrical grid or photovoltaic system), ventilation, and cooling.

Note: All BESS contain quantities of hazardous materials. In the event of an emergency with a BESS, a toxic environment may be created that is not visible. Metering of the environment by hazardous materials crews is necessary as is the usage of full personal protective equipment. Massive quantities of water over an extended period is the only established means of preventing continuous thermal runaway in a lithium-ion battery. Provisions for controlling hazardous runoff should be implemented.

**PHOENIX REGIONAL
STANDARD OPERATING PROCEDURES**

PHOTOVOLTAIC INSTALLATIONS

M.P. 205.20B

11/19-N

Page 1 of 3

PURPOSE

This procedure will establish a standard approach and response to Photovoltaic (PV) installations.

POLICY

It is the policy of the Central Arizona Life Safety System Response Council to respond to reports of emergencies in facilities that have PV systems. Our objective is to provide for life safety and reduce property damage when and where it's safe to do so. It is important to note that because of the significant hazard they present, PV installations will change the way we operate in facilities that have them. Firefighters must recognize the existence of the PV installations early in an incident and know the associated hazards.

PHOTOVOLTAIC SAFETY AWARENESS

PV systems are electrical generators. Photovoltaic arrays generate electricity by converting light energy into electrical energy. These systems are always generating electricity within the modules when they are exposed to light. Grid-tied systems can have electricity back feeding into the inverter until the disconnects are operated.

Photovoltaic Systems are found in residential, commercial and utility installations. All these systems represent a potential electrical shock hazard. Monsoon storms, hail, exposure to fire, or vandalism can create damage to the system which may cause electrical faults. These electrical faults may create a hazardous condition that can override the designed safety systems. Firefighters should use extreme caution when approaching PV systems and the structures they are found on.

DANGERS OF PHOTOVOLTAIC SYSTEMS

PV systems create Direct Current (DC) that must be converted to Alternating Current (AC) for use in the electrical grid; this is done through an inverter. Depending on the type of PV installation and the occupancy, the expected voltages produced are as follows:

- Residential: Up to 600 Volts DC
- Commercial: Up to 1000 Volts DC
- Utility Installations: Up to 1500 Volts DC

Note: Once converted through an inverter 1500 volts of DC current becomes 35,000 volts of AC current.

Emergencies involving PV installations and associated equipment contain hazards unique to electrical systems. This includes an electrocution hazard, toxic products of combustion, and thermal burns from electrical arcing.

PV installations may consist of the PV cell, multiple cells mounted into a module, multiple modules mounted into an array, invertors, disconnects and electrical conduit. Some installations may have a Battery Energy Storage System (BESS).

**PHOENIX REGIONAL
STANDARD OPERATING PROCEDURES**

PHOTOVOLTAIC INSTALLATIONS

M.P. 205.20B

11/19-N

Page 2 of 3

Hazardous compounds are used in the manufacturing process to make the cells. If panels are involved in fire, PPE including SCBA shall be worn. Exposure reduction through on scene decontamination shall be utilized.

Disconnects must be utilized to isolate the PV system from the electrical grid and BESS if present. It is important to note that some components of the system may continue to hold energy, this concept is called stranded energy and can represent a potential source of injury. PV panels or modules can be covered with opaque tarps to stop the generation of electricity.

Building integrated PV roofing tiles or shingles are unique in that they serve as the finished roof and generate electrical energy. This type of roof system not only has the electrical hazard associated with it, but they are extremely slippery and represent a fall hazard. Roof operations shall not be conducted on a building integrated PV tile or shingle roof.

When addressing concealed spaces including the attic, consider that electrical wires coming from the PV panels may be energized. It's possible for the aluminum frames of panels and the metal components of mounting racks to become charged if the system has sustained physical damage. Avoid contact with these components.

EMERGENCY RESPONSE PROCEDURES

Firefighters should identify the presence of PV installations early in the incident. Indicators that a PV installation is present are as follows:

- Visible array of PV panels
- Conduit coming from roof
- Invertors mounted on a wall or the ground next to building electrical panel
- Signage found around the electrical system

The presence of a PV installation shall be announced on the tactical radio channel and acknowledged by Command. It is critical that everyone on the fireground is aware of the presence of a PV installation. For example, interior companies must be aware of the potential for live electrical power to be still active in the attic and roof operations may not be possible depending on the layout of the PV array.

When a PV installation is present in a residential or commercial application, and when safe to do so, all disconnects should be operated to electrically isolate the system. In order to fully secure utilities to the structure firefighters should address the following:

- De-energize power coming into the building from utility company.
- De-energize electrical circuits leading from the PV system.
- Operate the rapid shut down switch to isolate the DC power for the PV system and confine the power to the array.
 - Older systems may not have this “rapid shut down switch” function and de-energizing procedures above will leave the circuit from the array to the disconnect fully energized.

**PHOENIX REGIONAL
STANDARD OPERATING PROCEDURES**

PHOTOVOLTAIC INSTALLATIONS

M.P. 205.20B

11/19-N

Page 3 of 3

- Evaluate the structure for the presence of a BESS and operate the disconnect if possible.

If a Responsible Party (RP) is available attempt to obtain information about the system and inquire if the PV installation includes a BESS. Direct the RP to contact their installer to respond to assess and mitigate hazards associated with the system.

FIRE IN THE PV ARRAY (RESIDENTIAL AND COMMERCIAL)

In the event that the PV array is involved in fire it's possible to use water to extinguish the fire after the electrical disconnects have been operated. A fog pattern delivered at a minimum of a 10-degree pattern from a minimum distance of 20 feet away will provide for the safe application of water on a PV array. This tactic may only be employed on PV installations up 1000 volts. Most residential and commercial PV systems generate less than 1000 volts. This tactic may not be employed on high voltage utility PV installations.

PV installations are becoming common in parking lots for electrical generation and to provide covered parking. In the event of a car fire in one of these systems it's critical to operate the electrical disconnects that feed the system. These systems are an example of where the decision to apply water to the panels may need to be made. It is mandatory to operate the disconnects prior to the application of water. These installations represent a unique hazard as the modules are overhead.

PHOTOVOLTAIC GENERATING STATIONS (UTILITY SUBSTATIONS)

In large utility substation events we will not engage in any activities related to fire suppression inside the facility. We will simply isolate the area. All fire department personnel will remain outside the fence line and protect exposures as needed. Careful coordination with the proper utility company representatives is required before any action may be considered.

**PHOENIX REGIONAL
STANDARD OPERATING PROCEDURES**

Portable Radios

M.P. 205.21

05/18

Page 1 of 5

Purpose

The purpose of this procedure is to outline the features and proper use of portable radios.

The best means of communication at an emergency scene is face-to-face. Face-to-face communication should be utilized whenever possible within the company or sector.

Portable radios will be used whenever distance or circumstances prevent face-to-face communication. Radio transmissions should be prioritized and concise.

Radio Familiarization

It is critical to be familiar with the operation and position of all portable radio capabilities and controls. This familiarity will allow personnel to operate their radio in zero visibility.

Current portable radio equipment is the Motorola APX7000XE. The front of the radio houses both the speaker and microphone to receive and transmit messages. An additional microphone is located on the back of the radio. The rear microphone is used primarily by the radio software to reduce background noise in the radio transmissions, however, if the front microphone fails, the rear microphone can be used to transmit.

The top of the radio has many of the radio controls. The removable antenna is located on the top right.

APX radios have multiple channel capabilities. The Hazard Deck "A": (Fire Channels) 1 through 16. The Non-Hazard Deck "K" (Trunked Channels) 1 through 16. The Phoenix Police channels are also located in the radio programming, amongst additional channels that allow seamless interoperability with many outside agencies when needed.

The channel selector knob is located immediately next to the antenna. Turning the channel selector switch clockwise enables the user to access channels 1 through 16. Channel 16 on both the "A" and "K" decks are programmed with the same information as the Channel 1 position on the respective deck. A1 and A16 are both programmed as Fire Channel 1. K1 and K16 are both programmed as Fire "K" Deck 1. In the event you are unable to determine what channel you are operating on, completely spinning the dial either direction will place you on Channel 1 where a dispatcher is always staffed.

A small black toggle switch at the base of the channel selector knob will lock or unlock the programmed buttons. When the switch is to the right in the lock position, you will not be able to use any of the side buttons with the exception of the Push-To Talk (PTT) button.

**PHOENIX REGIONAL
STANDARD OPERATING PROCEDURES**

Portable Radios

M.P. 205.21

05/18

Page 2 of 5

The flat selector switch or toggle switch adjacent to the channel selection knob allows the user to switch between hazard deck (RED) "A," the non-hazard deck (YELLOW) "K," and the Phoenix Police (BLUE) "A" deck patrol channels.

The on/off/volume selector switch is the second knob from the antenna. The knob will turn the radio on or off and control the radio volume. Turning this knob clockwise turns the radio on and increases radio volume.

Between the antenna and the channel selector knob is the orange emergency traffic button. Depressing this button sends an emergency traffic signal to the dispatch center identifying the unit ID of the portable radio. Dispatch will contact the unit to verify/confirm emergency traffic transmission.

The left side of the radio (as the user faces the speaker) has several buttons; the top button (purple) is the backlight button. Depressing this button will illuminate the screen to display the current channel. The long vertical button is the push-to-talk (PTT). This button must be depressed to transmit radio messages. The radio cannot receive messages while this button is depressed. Below the PTT button are the channel zone up and channel zone down buttons. Depressing these buttons will cycle the zone of channels that the radio is on. When you reach the desired zone, release the button and the zone will lock to that selected zone. Then you can change to the correct channel as needed.

Turning the radio off and then on again will reset the radio to the zone that is selected on the top of the radio on the multi-colored sticker. Simply change that selector to the correct default zone that you wish to be on.

The right side of the radio is equipped with contacts for a remote mic (RSM). The recognized best practice is to place the radio in your turnout coat pocket and use an RSM remote mic clipped to your turnout coat to protect the radio from the environment whenever possible

The battery can be removed by pressing the release tabs on both the left and right side of the battery.

Radio Operation

All operations members will have a portable radio assigned for their use. Each member will be responsible for the security, proper use and maintenance of their radio. All radios should be checked for proper operation at the beginning of each shift/whenever necessary. Radios not functioning properly should be red tagged and the PFD Service Desk (602-261-8030 Option 1)

**PHOENIX REGIONAL
STANDARD OPERATING PROCEDURES**

Portable Radios

M.P. 205.21

05/18

Page 3 of 5

should be notified. Any radios unaccounted for must be reported immediately with a Police Report and LSD form completed before a replacement can be issued.

Each member is responsible to carry their assigned radio on all emergency incidents. At other times the radio will be carried at their discretion or secured in the fire vehicle.

The Captain or designee should ensure that each member is rostered into the MCT and attached to the proper radio position. Each apparatus has assigned radios and positions that are coded into the CAD dispatch system for safety and accountability. It is important that when a member is using a radio, they are using the radio they have been assigned in the MCT roster.

Battery status should be checked on a daily basis. A flashing green/yellow light on the vehicle charger indicates that the batteries need reconditioning and the battery should be exchanged with a fully charged battery from the station charger, and the old battery placed into the station charger for reconditioning.

The use of the order model is required when transmitting or receiving messages.

Portable radio identification is as follows:

- Engine 1 or Ladder 1 will apply to the Captain of the Fire Company.
- Pump 1 or Truck 1 will apply to the Driver of the Fire Company.
- The remaining personnel will go by their Fire Company ID and their name.
 - Example: Engine 1 -- Firefighter Jones to Command
- Single person vehicles will use their assigned vehicle ID

PHOENIX REGIONAL
STANDARD OPERATING PROCEDURES

Portable Radios

M.P. 205.21

05/18

Page 4 of 5

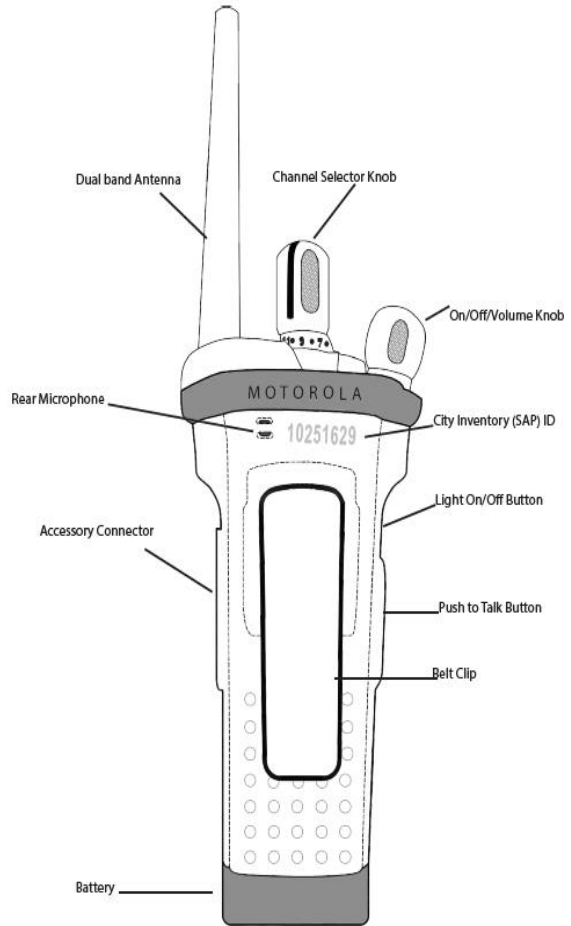
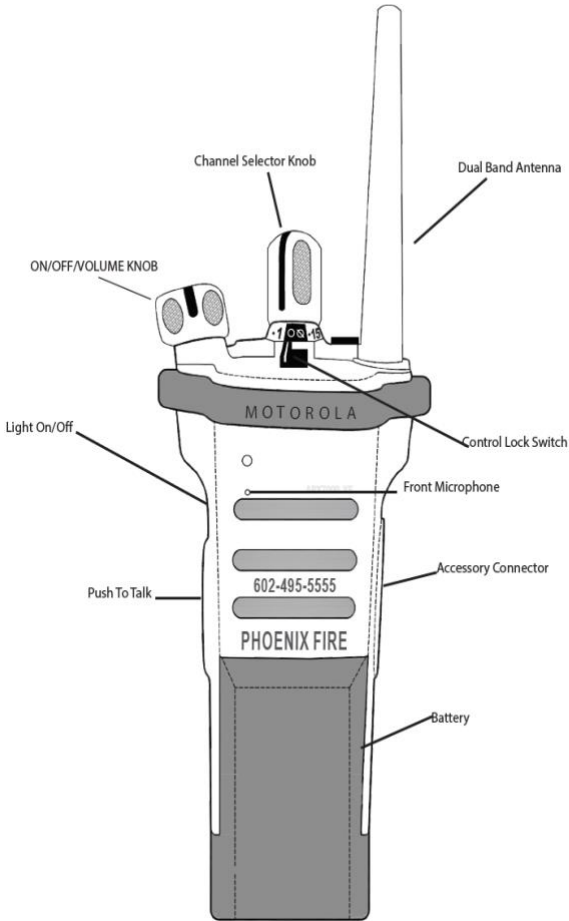

PHOENIX REGIONAL
STANDARD OPERATING PROCEDURES

Portable Radios

M.P. 205.21

05/18

Page 5 of 5

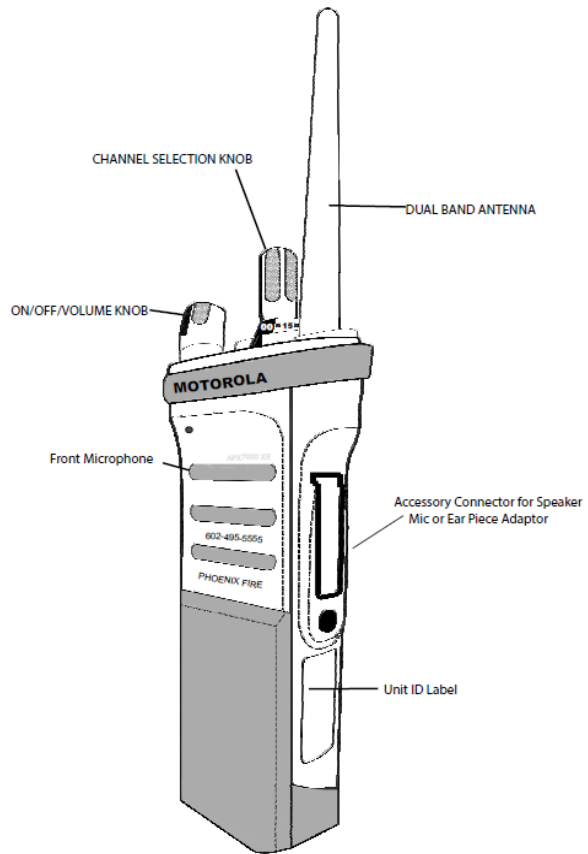
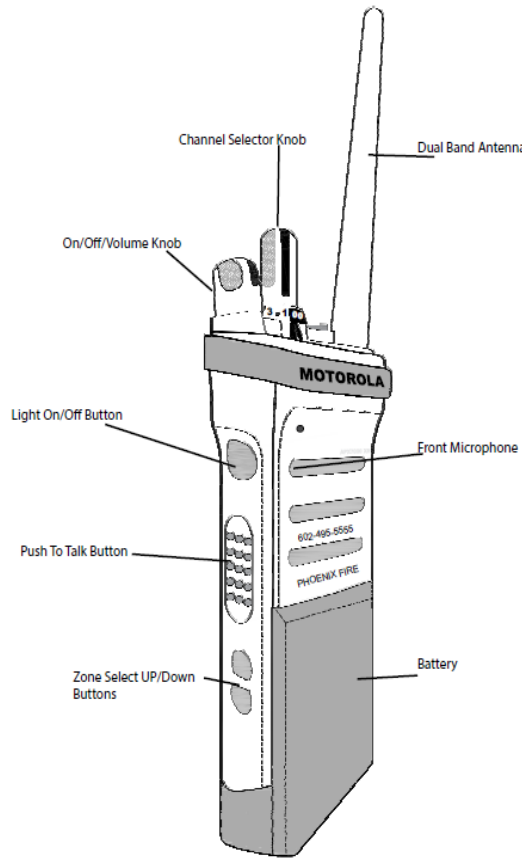
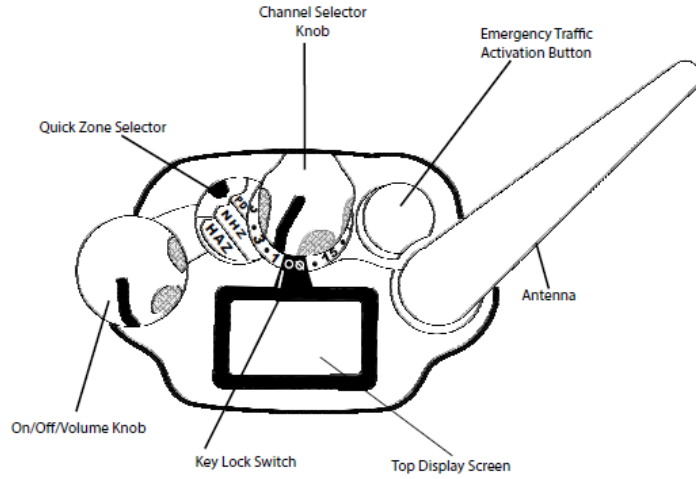

**PHOENIX REGIONAL
STANDARD OPERATING PROCEDURES**

SURGICAL EMERGENCY MEDICAL RESPONSE

M.P. 205.22

12/19-N

Page 1 of 5

PURPOSE

The Surgical Emergency Response Team (SERT) is a resource that can be called upon by on scene personnel when they encounter a patient who requires life or limb saving procedures which exceed the capabilities of the EMS personnel on scene service or who cannot be extricated and transported in a reasonable amount of time from the scene to definitive treatment.

GUIDING PRINCIPLES

In general, a SERT is utilized in a situation where a life-saving procedure, such as an amputation, is required due to the inability to extricate a patient. Life before limb concept is utilized as a life-saving measure, not as a time saving measure.

SERT should be assembled and ready to respond within thirty (30) minutes of a request with standard life-saving equipment.

POLICY

The Incident Commander, in consultation with the treatment/rescue sector on scene will be the responsible person to activate the Surgical Emergency Response Team (SERT) by calling the Phoenix or Mesa Fire Regional Dispatch Center and asking the surgical team to be mobilized). The Phoenix and Mesa Fire Regional Dispatch Centers have a contact list of qualified SERT members capable of deployment upon request of the Incident Commander.

First on scene unit ALS/BLS, which determines an advance medical need can start the SERT process. While not required, if the first on-scene units are not comfortable making the decision, the agency Medical Directors (or on-line Medical Control) should be in the decision-making process.

A second Command Officer will be added to all incidents where the SERT is requested. This should be the next closest Command Officer as assigned by the dispatching Alarm Room.

The Phoenix or Mesa Fire Regional Dispatch Tactical Radio Operator (TRO) will then contact the assigned Trauma center via the predetermined facility activation process and ask for the team to prepare to be transported to the scene. See appendix attached.

The TRO will then send the closest available Battalion Chief to the trauma center closest to the incident to pick up the team and transport them to the scene of the incident.

The Battalion Chief will be responsible for escorting the team to the scene and assuring scene and surgical team safety. The Battalion Chief will provide a safety brief to the surgical team enroute to the scene. The BC will get the on scene Medical Lead in direct contact via phone or radio with the onboard

PHOENIX REGIONAL
STANDARD OPERATING PROCEDURES

SURGICAL EMERGENCY MEDICAL RESPONSE

M.P. 205.22

12/19-N

Page 2 of 5

SERT physician to be inform of patient condition, the plan in progress and what they will need from the SERT on arrival.

The Battalion Chief will announce to the Incident Commander the arrival of the SERT and then introduce the SERT to the treatment/rescue sector on scene who will in turn direct them to the patient and provide a debrief on the scenario.

On arrival the SERT will establish Medical Direction and will work under the Incident Command as patient treatment, extrication, and transport is in process. Chain of Command will be followed by all members at incident. The surgeon or EMS physician from the SERT will then assume control of patient care at the scene and during patient transportation to the hospital.

The Fire Department personnel will assist the SERT with procedures and interventions that are in their standard EMS protocol. The SERT will be responsible for performing any procedures out of scope of practice or protocol for the EMS agency on scene. Fire Department personnel and SERT members will work together to provide life and limb saving procedures. Medical Direction (SERT) and Fire Department will have joint responsibility for patient care, transport, and transfer. The appropriate dispatch center will determine the closest most appropriate SERT to deploy and shall dispatch a Battalion Chief to that location. After the patient is stabilized at the scene, hospital destination will be determined by the treating physician.

GUIDELINES

The SERT shall be compromised of a Trauma Surgeon or EMS Physician, with the addition of a trauma nurse being at the discretion of the responding physician.

It is the responsibility of all responding hospital personnel to have appropriate personal protective equipment (PPE). This may include steel toe shoes/boots, helmet, eye protection, dust masks, work gloves and sturdy clothing, such as long sleeves and BDU style pants. Scrubs should not be worn once on the scene of the incident. The Fire Department may provide specialized PPE if possible as indicated by the factors of the incident.

Each Trauma hospital is responsible to outfit the kits as outlined below and ensure the kits are stocked and up to date.

Trauma surgeons, EMS Physicians (and nurses if part of the deployment team) and hospitals agree to participate in a yearly, at minimum or as necessary, technical rescue drills. They also agree that the surgeons, physicians, and nurses will commit to 24 hour/365 day availability based on a predetermined call schedule.

**PHOENIX REGIONAL
STANDARD OPERATING PROCEDURES**

SURGICAL EMERGENCY MEDICAL RESPONSE

M.P. 205.22

12/19-N

Page 3 of 5

These operations often also require a dedicated Battalion Chief. If the decision is made to bring in a helicopter or ground-based hospital team, another Battalion Chief will need to be dedicated to the function of safe transport of the team to the scene. Battalion Chief Vehicles can only provide transportation for two SERT personnel.

If field amputation is required, it is preferred for this skill to be performed by a physician when possible. Physicians who may perform this include a trauma surgeon or EMS physician trained in field amputation and the provision of critical care medicine in austere environments.

It is absolutely essential that any hospital-based resources be provided a safe operation. Very few of the responding hospital personnel have experience working or responding to a field call. The personnel and their supplies must be guided/protected/shielded to allow them to do the specific functions they need to do while being protected from scene hazards. That should all be prepared before they arrive, to include any need for a safe landing area; rapid transport to the patient; any necessary equipment for a safe platform to work on; lighting, ventilation, and physical access to the patient; a patient as prepared as possible including monitor, oxygen, tourniquet, IV or IO access, backboard and stretcher, clean plastic bag(s) for an amputated extremity and ice to put around it if needed, and a staged transport unit. This will allow the team to immediately assess the patient, provide anesthesia/analgesia as indicated, and perform any necessary intervention.

The standard life-saving equipment referenced below shall be predetermined, preassembled, readily available, clearly labeled, and stored in a predetermined location. Based upon the magnitude and nature of the incident, the standard life-saving equipment may require augmentation.

In some instances, an extricated patient may require rapid transport to a trauma center followed by delayed transport of the cooled body part when it is eventually freed. The treating physician in collaboration with on scene personnel will determine if body part is salvageable.

The charting paramedic will be responsible for documentation related to patient care at the scene. This will include all relevant pre-hospital care (IV placement, medication(s) administered, intubations, etc.) and surgical care in the field, including, but not limited to, arrival of surgical team, description of the surgical procedure(s) performed to free the patient, tourniquet application, etc.). Most of these incidents will require a debriefing session for scene personnel.

The SERT will need to communicate as early as possible with the closest most appropriate trauma center, to allow the hospital to be prepared for the incoming patient. Appropriate documentation of patient care will be completed by the treating SERT physician any time they provide care outside of the hospital during these scenarios. Any required hospital documentation will primarily be the responsibility of the treating SERT physician.

**PHOENIX REGIONAL
STANDARD OPERATING PROCEDURES**

SURGICAL EMERGENCY MEDICAL RESPONSE

M.P. 205.22

12/19-N

Page 4 of 5

SERT should consider and plan for extended operations when deployed to this type of call. Additional SERT resources should be placed on alert in the event operations extend beyond a reasonable work cycle as determined by the conditions specific to the incident (Phoenix Regional Standard Operating Procedure, 202.08, Rehabilitation Sector).

At a minimum, the items below are required. This list should assist the hospital staff in assembling and accounting for this unusual incident. This list would also allow staff to record what was returned to the hospital. It is the responsibility of the hospitals to restock any items, including medications, from the SERT cache used during the incident.

Note: Equipment and medications included in the list below represent best known recommendations. The equipment and medications lists are subject to change as needed to address the needs of the patient.

**PHOENIX REGIONAL
STANDARD OPERATING PROCEDURES**

SURGICAL EMERGENCY MEDICAL RESPONSE

M.P. 205.22

12/19-N

Page 5 of 5

EQUIPMENT	TYPE	
TOURNIQUET X4 JUNCTIONAL TOURNIQUET X1	(2-CAT OR SOFT-T, 2-SWAT-T)	
HEMOSTATIC GAUZE	QUIK-CLOT Z-FOLD/COMBAT GAUZE HEMOSTATIC DRESSING	
TRAUMA PADS	4 PKGS TRAUMA PADS	
SCALPELS	DISPOSABLE, 2 #10 BLADE 2 #22 BLADE ON HANDLES	
HEMOSTATS	SIX (6) 5 INCH CURVED WITH FINER TIP TWO (2) 7 INCH KELLY CLAMPS	
SAW (2)	GIGLI SAW WITH 2 HANDLES SIMILAR TO FEMA CACHE	
SCISSORS	ONE (1) 5 INCH MAYO, PLASTIC HANDLED BANDAGE/ORTHO SCISSORS	
CLAMPS	TWO (2) UMBILICAL CORD CLAMPS (HIGHER # RECOMMENDED – GET INPUT FROM TRAUMA TEAM)	
SYRINGES	SIX (6) 10 ML SYRINGES SIX (6) 3 ML SYRINGES	
NEEDLES	SIX (6) 18 G NEEDLES, 1.5 INCH SIX (6) 25 G NEEDLES, 1.5 INCH	
SURGICAL CLIP	ETHICON AUTO CLIP APPLIER, LARGE	
KERLEX	FOUR ROLLS KERLEX	
TAPE	TWO (2) ROLLS 4" SILK TAPE, TWO (2) ROLLS 1" SILK TAPE	
GAUZE	SIX CONTAINERS OF 4X4 GAUZE SPONGES	
TOWELS	STERILE TOWEL PACK	
SHEETS	STERILE ¾ SHEETS, TWO (2)	
SUTURES	APPROPRIATE FOR AMPUTATION	
STERILE TAPE	STERILE ¼" UMBILICAL TAPES	
BOWEL BAG	ONE (1) BOWEL BAG	
ACE WRAPS	ACE WRAPS: TWO (2) 4", TWO (2) 6"	
COBAND	COBAND 4 INCH WIDTH X2	
BLOOD TUBING	TWO (2) SETS BLOOD ADMINISTRATION TUBING	
IV STARTER KITS	FOUR IV STARTER KITS, IVF TUBING X2, 500 ML NSS X2	
SKIN PREP	FOUR (4) CHLOR-PREP SKIN PREP STICKS	
SPECIMEN BAGS	FOUR (4) PLASTIC SPECIMEN BAGS (AMPUTATION COLLECTION BAG)	
GOWNS	TWO (2) SURGICAL GOWNS	
STERILE GLOVES	STERILE GLOVES: THREE (3) EACH, SIZE 7, 7 ½, 8	
MASKS AND HAT	MASKS, HATS	
GLOVES	SEVERAL PAIR UNSTERILE NITRILE GLOVES	
FOLEY	FOLEY KIT	
CHEST TUBES X2	20 OR 24F WITH TROCARS WITH HEIMLICK VALVES X2 AND FOLEY BAG X2	
CRIC KIT	CRIC KIT WITH #6 ETT WIRE REINFORCED	
STERILE SALINE	TWO 500ML BOTTLES STERILE SALINE/IRRIGATION	
ISTAT & CARTRIDGES	OPTIONAL	
PELVIC BINDER		
CLAMPS		
USAR MODEL EQUIPMENT	JUMPSUIT, HELMET, STEEL TOE SHOES.	
SUGGESTED MEDICATION	AMOUNT	
FENTANYL	EIGHT (8) 100 MICROGRAM VIALS	
VERSED	THREE (3) 10 MG VIALS	
KETAMINE	FOUR (4) 100MG VIALS	
ROCEPHIN	TWO (2) 1 GRAM VIALS	
CLINDAMYCIN	900 MG IV	
SODIUM BICARBONATE	OPTIONAL	
LIDOCAINE	1% WITH EPINEPHRINE FOUR (4) 30 ML BOTTLES, PLASTIC	
RAPID SEQUENCE INTUBATION DRUGS	DETERMINED BY SERT ETOMIDATE, ROCURONIUM, SUCCINYLCHOLINE, VECURONIUM	

PHOENIX REGIONAL STANDARD OPERATING PROCEDURES	
Policy Name: COMPANY FUNCTIONS & DEPLOYMENT OF MR & LA UNITS	Policy Number: M.P. 205.23
This policy is for internal use only and does not expand an employee's legal duty or civil liability in any way. This policy should not be construed as creating a duty to act or a higher duty of care, with respect to third party civil claims against employees or the Phoenix Fire Department (PFD). Remedies for violations of this policy, if proven, are limited to administrative disciplinary action against PFD employees.	
Related Policies: 201.00, 205.01	
Other Reference:	
Date Implemented: 05/2022-N	Review Date: 05/2028

PURPOSE

The purpose of this procedure is to establish the capabilities and functions of non-traditional units and define their role in regional response. Defining the role of each unit will allow incident commanders, dispatchers, and company officers to call for and deploy the appropriate resource who can best accomplish the operational need.

POLICY

The following definitions will serve to outline the capabilities and functions of the non-traditional resources operating throughout the automatic-aid system. The Central Arizona Life Safety System Response Council requires that all fire stations have at least one NFPA 1710 compliant fire engine company in every fire station. This procedure is not intended to limit the scope of non-traditional units when individuals with sufficient training, certifications, and PPE are available to meet a critical operational need.

MEDICAL RESPONSE UNIT (MR)

MRs are fully staffed 4-person crews with a qualified engineer and company officer. These units primarily respond to medical calls and can fulfill all normal EMS response requirements based on the unit's level of EMS certification (ALS/BLS). On fire incidents, a MR can be used to supplement general firefighting duties as assigned by command. MRs cannot replace an engine, ladder, or squad company for fire suppression, rescue, and special operations type incidents.

- **Staffing:** 4-person crew including two firefighters, one engineer and one captain.
- **Hazard Zone Capability:** All crew members are trained firefighters and can operate in a hazard zone.
- **EMS Capability:** Primarily staffed as an ALS unit but can be staffed BLS when personnel limitations dictate.

- **Limitations:** MRs utilize a smaller vehicle than a traditional fire engine or ladder. These smaller units provide less protection when operating near moving traffic. Company officers and incident commanders should consider a back-up unit to support MRs operating under these conditions. MRs do not carry hose, water or ladders; this means the personnel can support firefighting operations, but the vehicle will have limited usefulness.

MR Units may only respond to incidents without the support of another unit on the following nature code categories: BLS, ALS, SERV and MISC SERVICE.

LOW ACUITY UNITS (LA)

LA units are staffed by 2-person crews that are trained firefighters. LA units primarily respond to low acuity incidents when a four-person crew may not be required. These units offer limited capabilities to respond to critical emergency incidents and should be backed up by an Engine, Ladder, or Squad (all hazards company) when the incident dictates. **LA units may respond to fires in certain jurisdictions** but should only be assigned by command to support an appropriately staffed, NFPA 1710 compliant, 4-person fire company when conducting firefighting operations. LA units can be assigned in the same way a 2-person rescue unit operates on the fireground.

- **Staffing:** 2-person crew that varies in certifications and rank.
- **EMS Capability:** May have ALS or BLS members but only fulfills the personnel requirement for low acuity BLS calls.
- **Limitations:** LA units will not usually have a company officer and should be supervised by another unit when operating on large incidents. LA units are designed to meet very low acuity needs and should be backed-up by personnel or an appropriate all-hazards unit if an LA is assigned to any other task.

LA Units may only respond to low acuity type incidents without the support of another unit on the following nature codes:

ABDOMINAL PAIN	CHECK WELFARE	ILL PERSON (HEAT)
ASSAULT	CHECK CROWDING	ILL PERSON
MINOR ASSAULT	CUTTING	INJURED PERSON
ASSLT* STAGE FOR PD	MINOR CUTTING	MINOR INJURY
BACK PROBLEM	CUTTING*STAGE FOR PD	LOCK OUT
MINOR BACK INJ	PERSON DOWN	MEDICAL ALARM
ANIMAL BITE	STUCK ELEVATOR	MISSING PERSON
MINOR BITE	EYE INJURY	ILL PERSON (NOSEBLEED)
BURN INJURY	MINOR EYE INJURY	CHECK AN ODOR
MINOR BURN	FALL INJURY	OPEN HYDRANT
CHECK BEES	MINOR FALL INJ	CHECK POOL
CHECK ELECTRICAL	CHECK FLOODING	CHECK REFRIG
CHECK HAZARD	ILL PERSON (HEADACHE)	SEIZURE

SERVICE CALL
SNAKE REMOVAL

UNKNOWN MED CODE 2
CHECK LINES DOWN

***The list above represents nature codes for which an LA Unit may respond if personnel have the proper training and equipment. Decisions regarding which nature codes from the list above an LA Unit can respond to will be made by the individual Fire Department.

MR & LA UNIT FUNCTION WITHIN AUTOMATIC AID

The automatic aid agreement establishes that participating departments deploy the closest most appropriate resources to emergencies, regardless of municipal boundaries. Also, the automatic aid agreement allows some flexibility for the deployment of specialized units when predefined by Phoenix Regional Standard Operating Procedures.

The Central Arizona Life Safety System Response Council allows the establishment of predefined response areas for MR and LA Units within municipal boundaries. MR and LA Units are required to be deployed across these predefined municipal boundaries when they are the closest unit to a type of call where an imminent threat to life is presumed as follows:

1. Codes
2. Childbirth
3. Person, Child, or Infant Choking
4. Drowning
5. ALS Seizure

LA Units are to be deployed on these incidents across municipal boundaries to supplement the response if they are identified as the closest unit; they shall not be deployed in replacement of other units. Additionally, a gunshot wound involving a law enforcement officer is included as it is likely that the officer will be extracted from the hot-zone immediately by other officers to a cold-zone where treatment can occur rapidly.

On all the above incidents, consideration for the need of an MR or LA Unit must be evaluated by the responding Company Officer, and when applicable, Command Officer. When the incident does not necessitate the need for an MR or LA response, these units should be canceled whenever reasonable. Like all fire companies, MR and LA Units should maintain awareness when not in quarters of incidents around them and may request to add on to critical calls when they believe their response will make a positive difference on the incident outcome.

***With Department approval, an MR will be dispatched to all MR approved nature codes (BLS, ALS, SERV and MISC SERVICE) when the MR is closest unit.

**PHOENIX REGIONAL
STANDARD OPERATING PROCEDURES**

Operations at Violent Incidents
M.P. 206.01 01/18 Page 1 of 10

Purpose

The purpose of this procedure is to establish guidelines for fire companies operating at incidents where violence has occurred or could potentially occur. The Phoenix Fire Department will always strive to treat all patients as quickly and as safely as possible. This procedure is meant to provide a foundation for working in any violent incident environment and in any level of complexity. Responsibility and accountability for firefighter safety lies at all levels of an incident organization, including the strategic, tactical and task levels.

Overview

Violent incidents or incidents that have the potential for becoming violent are no less dangerous to firefighters than the traditional fire scene. These incidents include calls in private residences or businesses to large-scale public gatherings. Each incident has its own unique challenges for our service delivery as well as managing our firefighter's safety. The beginning of the fire department response is a call for service typically through our dispatch center. Once dispatched, it is imperative that our incident command system utilizes the same strategic decision making for violent hazard zones as it does for the traditional fireground hazard zone. Having two separate incident evaluation systems for different hazard zones is not logical. The standard strategic decision making model is the best-suited system for this type of hazard zone evaluation and management.

The standard decision making model for the Phoenix Fire Department includes:

1. Size up and Identification of the Critical Factors
2. Risk Management
3. Strategy
4. Incident Action Plan
5. Tactical Objectives
6. Review and Revision

This process is ongoing and continual, which requires a review/revision based on actions and conditions until the tactical objectives are met. In these incidents, the key tactical positions are:

- Triage
- Extrication
- Treatment
- Transportation

It is possible that other tactical positions may be necessary however the above are foundational to meeting the life safety tactical objective.

**PHOENIX REGIONAL
STANDARD OPERATING PROCEDURES**

Operations at Violent Incidents

M.P. 206.01

01/18

Page 2 of 10

Dispatch Center Responsibilities

Most emergency responses begin with a call to 911. It is the responsibility of the Phoenix Regional Dispatch Center to process these calls. Based on the information taken during a 911 call, the appropriate nature code is selected for the incident. Specifically, violent incidents come into the dispatch center in one of two ways. The incident takers can receive the information directly from the 911 caller or they receive the information secondarily from the PD dispatch center. In either instance, the standard method of information gathering, processing and dispatch is the same. The greatest variable to the accuracy of the dispatch nature code is the quality, quantity and timeliness of the information gathered by the incident taker. Initial information is not always complete or accurate so the incident takers and supervisors are trained to take a pessimistic approach to these incidents with regards to service delivery and firefighter safety. The information provided by the caller is the weakest part of our information gathering system. The system improves once we begin our strategic decision making model.

In instances when the incident information provided to the incident taker is inaccurate or incomplete, it is necessary for company officers and command officers to utilize their discretion to ensure the safest actions. Communications with the tactical radio operator (TRO) should be two-way communications. As the TRO gains information regarding these incidents they are responsible to convey it as quickly and appropriately as possible. It is important that Company Officers and Chief Officers communicate critical information to the TRO as well to ensure that this information can be relayed to all onscene and responding resources assigned to incident. In the case of direct radio communications with Fire Companies and PD units, an effort must be made to share pertinent scene information back to AHQ to close the communications and accountability loop.

It is the responsibility of the Phoenix Regional Dispatch Center to maintain phone communications to any law enforcement dispatch center or communications system that fire units do not have direct radio-to-radio communications. Phone communications becomes the best inter-agency information-gathering tool to incident situational awareness for violent hazard zones. Face-to-face or radio communications with officers on the street may not always be possible during the initial response of an incident. This link is imperative to the safety of firefighters and the effectiveness of the fire department mission within a violent incident hazard zone.

**PHOENIX REGIONAL
STANDARD OPERATING PROCEDURES**

Operations at Violent Incidents
M.P. 206.01 01/18 Page 3 of 10

Operational Response

1. Size Up

The ability to size up an incident is the primary step in achieving the tactical objectives. This is achieved by assessing the incident in a very standard way. This includes:

- What is the problem?
- What is getting in the way of me achieving the tactical objectives?
- What can hurt or kill me?

The initial step in quality size up includes accessing the appropriate Police Tactical Channel, if available, to begin listening to the incident communications. These communications allow insight into the dynamics and complexity of the incident. This allows the responding companies to begin to assess and plan for appropriate and safe actions. This is our standard size-up. The size-up for violent incidents should include:

- Dispatch information regarding the incident type or nature. This includes the type of violent actions of the incident if known (assault, stabbing, shooting, explosives, etc.).
- Location of incident and/or patients?
- Number of patients?
- Is there a history with this address and/or person?
- Does the incident nature code require units to stage?
 - If not, should that be considered?
- Is PD onscene yet?
- Is this a planned or unplanned incident?
- Is a Phoenix Fire Department Terrorism Liaison Officer (TLO - C958) onscene yet?
- Can units communicate directly with PD onscene either face to face or on the radio?
- Has PD defined an inner or outer perimeter?
- Are the patients located inside the inner-perimeter?
- If the scene is totally uncontained, can PD begin to extricate the injured patients to a safe treatment and transportation area?

The initial dispatch information is rarely complete. These situations evolve rapidly, and it is necessary to assume that the information, which is initially received, will change. It is important to approach these incidents slowly and cautiously. Over-committing prior to fully evaluating the critical factors can pose significant danger to firefighters and thus impacting their ability to delivery care.

Direct communications with PD is the best form of information gathering about these incidents. PD has the responsibility of hazard mitigation on these incidents. Fire/EMS resources are support resources necessary to triaging, treating, and transporting the injured. Communication with PD Officers, face-to-

**PHOENIX REGIONAL
STANDARD OPERATING PROCEDURES**

Operations at Violent Incidents

M.P. 206.01

01/18

Page 4 of 10

face or via radio will provide direct information as to the containment and coordination of the location and access to the injured. Direct communication and coordination are the most important steps to determining where and when Fire/EMS resources can access patients in the safest manner.

A significant resource in establishing the critical factors for a violent incident is the Phoenix Fire Department Terrorism Liaison Officers (TLO, C958). The TLO's mission is to provide an on duty, 24-hour law enforcement liaison for fire units regarding any police activities. C958 is a trusted partner with law enforcement from all levels of government (Federal, State, County and Local). Their primary mission includes information management regarding law enforcement activities and the safety, security and effectiveness of Phoenix Fire Department units in law enforcement hazard zones.

For pre-planned incidents that have the potential for violence, C958 will establish communication with the participating law enforcement agency and develop a unified plan to provide adequate fire department support to the incident. The plan will include direct supervision and communication of fire units as well as effective management of fire department unit's safety.

For unplanned incidents, on arrival, C958 will establish a liaison position with the jurisdictional law enforcement agency. The liaison is established to provide the incident commander real time information regarding critical factors, scene perimeters, police actions and coordination of police and fire activities. The Phoenix Police Department TLO (C958PD) is charged with establishing the same liaison position for the fire department.

2. Risk Management

It is critical that all hazard zone actions are based on a sound risk management plan. The ability to measure risk is only possible with adequate size up. Communication and coordination with PD is critical to size up and understanding the environment in which we are working. This allows us to utilize the risk management plan. The standard risk management plan that is used on the fire scene is perfectly suited for violent incidents.

- We will risk a lot, in a calculated manner, to save savable lives.
- We will risk a little, in a calculated manner, for savable property.
- We will not risk anything for what is already lost.

The use of this risk management plan will improve the incident commander's ability to provide a more predictable, safe environment to achieve our primary tactical objective of Life Safety. If it is possible for a crew or crews to enter a violent hazard zone with appropriate police protection to triage, treat and extricate injured persons as a part of a well-communicated plan, it should be done. This is a component of taking risk in a calculated, well-communicated manner.

It is important that crews are not lured into dangerous or uncontrollable situations to save nothing or something that is clearly lost. A firefighter that becomes injured or trapped due to uncontrolled violence is ultimately unable to do their job.

**PHOENIX REGIONAL
STANDARD OPERATING PROCEDURES**

Operations at Violent Incidents

M.P. 206.01

01/18

Page 5 of 10

A component of Police Incident Command is the establishment of an inner and outer perimeter. The area within the inner-perimeter is the Hot Zone. Fire/EMS resources shall never operate within the inner-perimeter. The area between the inner and outer perimeter is defined as the warm zone. Fire/EMS resources can operate in this area to triage, extricate, and treat patients within a well-coordinated and communicated plan with PD. The inner and outer perimeter can be fluid and change as the hazard changes. The Incident Commander's ability and need to remain aware of any changes is critical. The Incident Commander must communicate and adjust the plan based on any changes made to the hazard zone (inner and outer perimeter). C958 can play an integral role to improving the communications with PD. C958 has access to encrypted and specialty radio channels that are not accessible for Command Officers and Fire Companies. C958 simply becomes a valuable technical advisor to the IC in these instances.

3. Strategy

Incident strategy is not just meant for the fireground. It should be utilized in all types of hazard zones. Strategy defines the operational posture of the incident. The strategy also defines our actions based on our location and proximity to the hazard.

As in fireground operations, the standard strategies for violent incidents are the same. We are either operating in an Offensive or Defensive strategy. As on the fireground, it is critical that we do not mix our strategies on the incident. There should be one, over-arching strategy for every incident.

An offensive strategy at violent incidents means entering a well-defined warm zone (between the inner and outer perimeter) to treat or extricate the injured based on the clearly communicated and coordinated information from PD as to the location of the injured. This strategy involves communications with PD, the incident commander, sector officers and other crews operating on the same scene. This is done by considering the same elements that are critical on the fire scene; including how are the crews entering the scene and getting to the patients, maintaining an effective exit plan and consistently evaluating the conditions or environment. This requires controlling the conditions within our power or exiting to safe refuge when we can't control them. Communications is critical for accountability and it ensures that subsequent arriving units understand the plan. The factor of operating in the Offensive Strategy under Marginal Conditions also applies to violent incidents. We only operate under Marginal Conditions for life safety. Units exit as soon as possible, usually when we obtain an all clear or conditions force us to change strategy. Accountability is imperative upon exit from the hazard zone.

A defensive strategy is defined by taking a posture outside of the hazard zone to stage until the scene is deemed safe or to establish a triage, treatment and transportation system ready to accept patients that have been removed from the hot zone. This strategy is taken when we have prolonged violent incidents or during episodes that are so volatile that PD is unable to ensure safe areas or corridors for our efforts. In this situation, our presence in the hazard zone may be detrimental to police activity or we simply cannot plan for our safety or retreat. Again, a firefighter that becomes injured or trapped

**PHOENIX REGIONAL
STANDARD OPERATING PROCEDURES**

Operations at Violent Incidents

M.P. 206.01

01/18

Page 6 of 10

due to uncontrolled violence is unable to do their job.

It is possible that an incident may require a change in strategy based on the conditions and actions of either the hazard or PD. In this case, just as in the traditional fireground, it is critical to recognize changing conditions. Once recognized, we must clearly communicate the change and verify an accountability process to ensure all companies understand the change in strategy and retreat appropriately. This means removing crews to safe areas and being ready to meet our tactical objectives from this position once a PAR has been obtained.

4. Incident Action Plan

Violent incidents are very fluid and dynamic. The incident action plan (IAP) must be safe, well communicated and continually evaluated against the conditions and the effectiveness of the actions. This requires an incident commander. Whether the incident commander is a company officer in the fast attack mode or a battalion chief in a command post, the IC must manage the plan simultaneously with the work to ensure firefighter welfare and quality care. Direct communications with initial officers (any rank) is critical and the first steps of a unified command system. Just as in fireground operations, it is completely acceptable and necessary to initiate the Incident Command System from the fast attack mode in concert with our onscene PD counterparts.

As in fireground management, if the conditions and actions don't match the plan (IAP) or strategy, or the situation is not improving, a new IAP is required. The IAP must consider both firefighter safety and the effectiveness of the care. Law enforcement will not dictate a plan of action to our Fire Companies. It is the IC's responsibility to use the information that is gained through communication with PD to determine the best plan and coordinate that with the PD Officers working at the scene. Communicating any changes to the IAP insures that all units are working safely and within the same plan.

The IAP should always match the strategy. In an offensive strategy, firefighters will be actively entering the warm zone to protect life safety while consciously monitoring the conditions. In a defensive strategy, firefighters will identify what or who is lost, write it off and treat and transport everyone else exposed to the scene.

Violent incidents have the potential to require large amounts of resources. Depending on the potential and actual patient counts, upgrading these incidents as information becomes more available will be necessary. The complication of adding a mass casualty incident to a violent hazard zone should be considered in the initial size-up of these incidents. Standard mass casualty procedures apply if the tactical benchmarks can be met within an IAP that consciously accounts for firefighter safety.

The standard procedures for Level I and Level II staging are appropriate for these types of instances. Level I staging for single unit responses with PD should be utilized following standard practices. Level II staging requires active management by the Sector Officer with clear communications with the Incident

**PHOENIX REGIONAL
STANDARD OPERATING PROCEDURES**

Operations at Violent Incidents

M.P. 206.01

01/18

Page 7 of 10

Commander to best support the IAP. Staging in quarters is an acceptable option if the incident is within proximity or for long durations. However, staging in quarters should include being on the apparatus and actively monitoring Fire and PD radio channels for information regarding the incident and necessary response. Staging in quarters should not delay a company's ability to respond.

Level II staging should be utilized for 1st Alarm incidents or greater; or when it is impossible to establish a defined hazard zone upon the arrival of the initial companies. The incident commander should establish a Level II staging location in a safe location that allows company's access to the scene but remains clear of the potential hazard zone

Communications

The Phoenix Regional Dispatch System provides a direct link to all law enforcement agencies dispatch centers within the State of Arizona. Many Law enforcement agencies within the Central Region of Arizona are a direct connection via pre-established communications lines. It is the responsibility of the Phoenix Regional Dispatch System to take an active role in the managing the information sharing for violent incidents during incidents when direct radio-to-radio or face-to-face communications are not possible.

Currently, the Phoenix Fire Department has access to the tactical radio channels for the following Police Agencies:

1. Glendale PD
2. Peoria PD
3. Surprise PD
4. Tolleson PD
5. El Mirage PD
6. Avondale PD
7. Scottsdale PD
8. Paradise Valley PD
9. Tempe PD
10. Chandler PD
11. Mesa PD
12. Gilbert PD
13. Apache Junction PD

This communication and coordination is critical to successful size-up and safe, effective operations on violent incidents of any size.

Strategic Level Considerations

In the same manner, as on the fireground, a company officer is typically the initial incident commander (IC#1) for a violent incident. IC#1 is expected to operate at the strategic, tactical and task levels

**PHOENIX REGIONAL
STANDARD OPERATING PROCEDURES**

Operations at Violent Incidents

M.P. 206.01

01/18

Page 8 of 10

simultaneously until command has been appropriately transferred to a stationary battalion chief or shift commander (IC#2). This is a complicated task. It is necessary for IC#1 to process all the available information into the strategic decision making model to ensure the quality of care and firefighter safety is appropriate. The overall incident success is greatly improved when IC#1 can successfully process information accurately from the beginning. The best opportunity for accurate and timely information is direct communication with the PD Officers onscene. It is necessary to process this information with a pessimistic perspective and insure all actions are well communicated.

IC#1 should be cognizant of not only the initial incident evaluation but also the necessary actions for the other responding units. Safely staging resources until an appropriate size-up, strategy and plan can be formulated and then communicated is critical to incident success and firefighter safety. It is always easier to get companies into the hazard zone, than it is to get them out. The hazard zone on violent incidents can be dynamic and migrating rather than stationary.

IC#2 shall evaluate the incident in the same manner utilizing the same strategic decision making model to ensure the actions and the conditions are matching. This also increases the likelihood of a successful incident management and firefighter safety.

Direct communication with PD, either face to face or on the PD tactical radio channel is a critical factor to accurately managing the safety and effectiveness of fire department operations. When operating in the fast attack mode, IC#1 should ensure that they can communicate with PD on their tactical channel via portable radio. He/she can manage this very critical communication function or delegate to a qualified crewmember. Bottom-Line: If the incident commander is unable to get accurate, timely information regarding the hazard zone or the safety of the work environment, this may require a change in strategy and the removal of all fire crews from the hazard zone.

It is necessary to understand the mission of the Police Department when operating in a violent hazard zone. During an active violent incident, the main tactical objective for the police department is to eliminate or mitigate the hazard. This involves physically engaging the bad guy or bad guys and causing their surrender or forcefully eliminating the hazard. It is the fire department incident commander's job to ensure the fire department and the police department's tactical objectives can be done in the same proximity safely and effectively. In the event they cannot, the incident commander must remove the firefighters from the hazard zone until it is safe.

Tactical Level Considerations

Sector officers operating in violent hazard zone situations have the same responsibilities on the fireground. They must establish ownership for their geographical position or function-based sector and process their own decision model/size-up (all five steps) to meet the overall tactical objectives. This assessment is then communicated to the incident commander in the form of progress reports. This is standard to any hazard zone, and both captain level sector officers and battalion chief level sector officers can complete this. As in fireground hazard zone management, the use of battalion chief level

**PHOENIX REGIONAL
STANDARD OPERATING PROCEDURES**

Operations at Violent Incidents

M.P. 206.01

01/18

Page 9 of 10

sector officers is preferred simply from the stand point that the battalion chief and Field Incident Technician (FIT) can take a much more tactical level perspective due to not actively managing task level operations simultaneously to managing the sector. This allows for better communications and less distraction in evaluating conditions, actions and accountability.

Sector officers should also establish effective face-to-face communications with police officers or supervisors managing the areas in which the firefighters are working. Face to face communications should provide effective situational awareness and better understanding of the police department's strategy and incident action plan.

Sector officers should provide a resource assessment for the sector with concern for utilizing only enough resources necessary in the hazard zone to minimize exposure to the violent situation.

Effectively establishing triage, treatment and extrication of the patients to a safer area of the incident for transportation is most desirable. Limited exposure to violence or hazards decreases the possibility for injury to firefighters or the disruption of treatment of the patients.

Task Level Considerations

As with fireground awareness and safety, it is necessary for all firefighters to be responsible for their own safety. No incident command system or incident organization can out-perform bad personal decisions by the individual. It is necessary that firefighters remain aware of their surroundings, work together as crews to ensure each other's safety and communicate when things appear unsafe or rapidly changing.

It is critical that all members operating in any hazard zone function as a part of the incident organization and within a well-communicated plan. There is nothing safe about freelancing in any hazard zone. Everyone is accountable to themselves and their company officer. Each company officer is accountable to their sector officer. Each sector officer is accountable to the incident commander. This system is the best way to effectively manage the overall safety of everyone and the effectiveness of the overall hazard zone operations.

It is critical that each individual firefighter not be lured into dangerous or uncontrollable situations because of the police department or bystander's actions. All incident actions must be communicated to ensure the safety or security of areas or persons. Good intentions or an overly aggressive nature can easily lure individuals or crews into bad situations with significant consequences. Continual communications regarding situational awareness between crewmembers and their company officers is necessary.

Company officers should maintain and communicate simple and effective exit plans during operations in violent hazard zones. As in high-rise firefighting, continual management and awareness of areas of safe refuge are critical to firefighter safety. Once identified these areas should be communicated to the sector officer for situational awareness and sharing with other companies working within that geographical area.

**PHOENIX REGIONAL
STANDARD OPERATING PROCEDURES**

Operations at Violent Incidents

M.P. 206.01

01/18

Page 10 of 10

Unforeseen or Unpredicted Violent Situations

It is common for fire companies to, on a random basis, encounter situations that did not appear to be volatile or violent, but have become so. Quite often these situations surprise firefighters in the process of delivering service that has been done thousands of times before without incident. Historically, firefighters escaping without injury are usually because we can quickly over-power a situation or smoothly talk our way out of violence because of our good standing within the public. Neither is reliable or predictable enough to ensure any amount of success. The most effective means are true situational awareness and defensive tactics that limits our exposure to these scenarios.

The most effective actions when firefighters find themselves in an unpredicted, possibly violent situation is (run, hide, fight):

- Removing themselves to safety
- Communicate directly with PD over their tactical channel to request assistance
 - Communicating who, what and where
- Utilizing the emergency traffic button on our portable radios when it is not safe to speak
- Utilize any area of safe refuge or cover
- Only actively engage the aggressor as an absolute last resort
 - Fully commit to neutralizing the aggressor

The most effective method to ensure firefighter safety is to not allow us to be surprised or lured in to dangerous situations. This can be very difficult. When firefighters find themselves in a violent situation the safest thing to do is to remove themselves from the violence and retreat to safe refuge. Self-removal is not always easy. Firefighters should work in a minimum of pairs or even better as an intact crew to improve everyone's overall safety from violence. This will also improve maintaining situational awareness for all parties involved in the incident scene.

Active management of our environment and our proximity to patients is important to our overall safety. The key to close quarter interactions with patients is maintaining defensible space. Removing or coaxing patients to open areas or unconfined spaces can improve our defensible space. Due to the nature of our job, working near patients sometimes is necessary. Remain aware of their body language and communications. It may be reasonable to sometimes only treat emergent issues as an effective way to improve overall safety. Simply getting patients to an environment that firefighters can control (maybe with the assistance of PD) is important to reducing the overall exposure to violence. Furthermore, removing any items that may conceal weapons or eliminating dangerous items from proximity of the patient can significantly limit the overall exposure to violence. It is imperative that company officers and individual firefighters are continuously aware of their surroundings.

**PHOENIX REGIONAL
STANDARD OPERATING PROCEDURES**

GUIDELINES FOR CIVIL UNREST

M.P. 206.01A

08/20-N

Page 1 of 1

For many decades, the fire service has been called along with law enforcement to intervene in incidents involving civil unrest. Any civil unrest has the potential to cause for an increase in emergency calls. Civil unrest events can change quickly, and we have excellent SOP's that govern our response. The following is provided to supplement our policies with some guidance for our response to an incident involving civil unrest:

IMPORTANT SAFETY CONSIDERATIONS:

- No single company responses will be permitted in the predefined area (geo fence).
- All responses shall be coordinated with law enforcement and will include force protection/escort.
- Use of sirens and air horns should be avoided within the immediate area, lights may be used.
- Position apparatus in a manner that will allow for rapid, unobstructed retreat from the area. Also, apparatus must be parked in a manner that best protects the crew.
- Be smart with regard to your behavior. Stay alert and aware of what is happening around you and your crew. Back off and away from any potentially violent situation. Don't fuel civil unrest.

TACTICAL CONSIDERATIONS:

- In most cases, patients will be more effectively treated if removed from the scene to a determined treatment area (scoop and run). A great practice is for law enforcement to bring patients to us.
- When no lives are at stake, emphasis will be on protecting savable property. Buildings, vehicles, etc. that are fully involved with no or little exposure problem may be left to burn.
- When safe and well-coordinated, fire suppression efforts will have an emphasis on fast water, heavy streams to rapidly control and extinguish the fire and then to get out of the area. Routine salvage, ventilation, and overhaul practices may be discontinued. Use of hand lines should be limited. Roof operations should be avoided and ladder buildings only when necessary for rescue efforts.
- All fire units will enter the perimeter as intact groups with law enforcement, travel in groups, operate in groups, and return in groups.

OTHER CONSIDERATIONS:

- Any civil unrest has the potential of escalating into a major situation.
- Chief Officers will be added to all responses to provide for additional member safety in known areas of civil unrest.
- Fire Departments should be prepared to support law enforcement partners with rehabilitation of officers, treatment, and transportation as necessary.
- Terrorism Liaison Officers (TLO) are extremely valuable to assist with coordination of efforts. TLOs should be utilized at the tactical and strategic levels whenever possible.
- When multiple Emergency Operations Centers, Incident Management Teams, or other similar systems are operating regionally, information sharing amongst leaders is a best practice.

**PHOENIX REGIONAL
STANDARD OPERATING PROCEDURES**

FIREGROUND EXPOSURE REDUCTION

M.P. 206.02

11/19-N

Page 1 of 3

PURPOSE

The purpose of this procedure is to establish safe and active practices for exposure reduction. When operating within the hazard zone, toxic substances can accumulate on personal protective equipment (PPE), firefighting equipment, and on the body. These toxic substances include known carcinogens.

POLICY

The Phoenix Fire Department and our automatic-aid system partners within the Central Arizona Life Safety System Response Council have a shared commitment to firefighter safety. This commitment includes reducing exposure to known carcinogens, toxins and other potential hazardous substances. The guidelines within this procedure are intended to reduce firefighter exposure and contamination. All personnel shall protect themselves and their coworkers by following to this procedure.

DEFINITIONS

For the purpose of this policy the following terms are defined as:

- Exposure is defined as a person or equipment coming into contact with a known hazardous substance or carcinogen.
- Contamination is defined as absorption, inhalation and ingestion of known hazardous substances or carcinogens within the body.
- Decontamination is defined as the removal of hazardous substances or carcinogens from an employee's tools, PPE, clothing, body, and work area to the extent necessary to prevent or minimize exposure and contamination.
- Hot Zone is defined as the area including and immediately surrounding the hazard area, which extends far enough to prevent adverse effects to personnel outside the zone.
- Warm Zone is defined as the area outside the Hot Zone where personnel and equipment decontamination (and support activities) take place.
- Cold Zone is defined as the area that contains the command post and such other support functions deemed necessary to control the incident.
- Drop Zone is defined as the area established to place equipment after it has been decontaminated.

PROCEDURE

When firefighters are exposed to environments with hazardous substances or carcinogens those substances can accumulate on equipment, PPE, clothing, and the body. The presumption should be the accumulation will lead to contamination. Examples of hazardous environments are as follows:

- Structure fires
- Hazardous materials incidents
- Vehicle fires
- Brush fires
- Dumpster fires

**PHOENIX REGIONAL
STANDARD OPERATING PROCEDURES**

FIREGROUND EXPOSURE REDUCTION

M.P. 206.02

11/19-N

Page 2 of 3

Any incident or environment where smoke or off gassing is present for any duration of time can cause an exposure. Firefighters should be mindful that exposure to products of combustion, such as smoke, does not require visible conditions. All types of fire incidents often include a variety of combustibles (e.g., wood, paper, plastics, synthetics, fertilizers, pesticides, insecticides, solvents, petroleum products, and other unknown materials). The smell of hazardous materials or products of combustion indicates contamination. Inhalation, ingestion, and absorption of low quantities (measured in parts per million) or microscopic amounts can have a carcinogenic effect along with other adverse health effects.

Every member on the fireground needs to remain aware of the potential for exposure and contamination. This includes but is not limited to members performing fireground support operations (ladder work), the Engineer working at the pump panel, on deck crews, Safety Officer, Sector Officer, and Incident Commander. Unintended exposure of any personnel is possible due to shifting winds, expanding incidents, or unexpected events.

FIREGROUND EXPOSURE REDUCTION AND DECONTAMINATION GUIDELINES

Decontamination (decon) may be necessary for exposed or contaminated Fire Department personnel and/or civilians. All personnel exposed to products of combustion or contaminants should perform gross decon prior to entering the Cold Zone or leaving the incident scene. To facilitate this process, personnel are responsible for the following:

1. The Incident Commander is responsible for ensuring that a decon location is designated and announced on every applicable incident.
 - a. Generally, the decontamination location is setup by the first arriving engine company, or initial Incident Commander.
2. The Engineer of the fire company directed to setup decon shall establish and oversee the process. This includes setting up an approved hose line and other supporting decon equipment.
 - a. This hose setup should be established outside the Hot Zone, with enough water flow to facilitate decon without embedding contaminants into PPE and equipment.
 - b. To enable decon of multiple personnel, additional decon lines should be setup.
 - c. Depending on the length and extent of the incident a Drop Zone may be established. The Drop Zone should be established in a location that is downwind of personnel and may include placement of tarps or salvage covers.
3. Upon exiting the Hot Zone, personnel should remain on-air, and report directly to the decon location.
 - a. Those members with the lowest air supply should be decontaminated first.
 - b. Crew members should assist each other with rinsing off contaminants and debris. This should be a systematic process working from the collar-line down; remain mindful of high potential collection points such as the groin and armpits.
 - c. The objective is to rinse off contaminants without saturating the inner lining of PPE.
4. After the initial rinse personnel may go-off air using approved doffing techniques.
5. Personnel may begin decontamination of equipment (e.g., SCBA, tools, helmet, etc.) when appropriate. Consideration should be given to wearing the proper PPE for this process (i.e., EMS gloves and eye protection).

**PHOENIX REGIONAL
STANDARD OPERATING PROCEDURES**

FIREGROUND EXPOSURE REDUCTION

M.P. 206.02

11/19-N

Page 3 of 3

- a. Soft bristle scrub brushes and department issued soaps and cleaners should be used to assist in the decon process.
6. Depending on the extent and length of the incident, all PPE may be left in a prepared Drop Zone.
7. Personnel should use department approved methods for cleaning of the head, neck, face, hands, and any other exposed skin.
8. When possible, personnel should resist the urge to eat or drink until initial decon is complete.
9. After decon, personnel should cool down to decrease the potential for contamination.
10. Every attempt should be made to limit contamination of the Cold Zone. For example, personnel shall complete the decon process prior to entering the Rehab Sector (if established).

If personnel are reassigned back into the Hot Zone, upon exiting they should go through the decon process as stated above. Examples include, salvage and overhaul efforts, retrieving hose lines, etc. When reloading hose lines personnel should be aware of the potential risk of exposure. Contaminates should be cleaned off hose lines prior to reloading. Personnel should take appropriate decon steps after reloading all equipment. Once released from the incident by the Incident Commander, it's recommended that PPE be bagged and sealed at the scene to prevent off gassing and contamination of the apparatus cab.

POST FIRE DECON

It is highly recommended that all personnel exposed to the products of combustion, or any potentially harmful chemical or biological toxins, complete a comprehensive decon as soon as possible after the exposure. The Incident Commander may place units with exposed personnel out-of-service until decontamination is complete. A crew member should monitor the radio in case an urgent call is dispatched. These units should immediately address the following:

- Switch out into your second set of turnout gear and send in contaminated turnouts for proper cleaning. Replacement hood, shroud, gloves and brim should be acquired.
- Decontaminate equipment (e.g., SCBA, helmet, mask, radios, tools, etc.).
- Decontaminate apparatus cab.
- "Shower within the hour." Consideration should be given to taking a cool shower when possible to minimize potential contamination by closing pores of the skin.
- Change into a clean uniform and wash soiled uniforms.
- Return apparatus to state of readiness and go back into service as soon as possible.
- Complete the Toxic Exposure form.

OPERATIONAL INFORMATION

Personnel are encouraged to carry a complete and clean uniform that can be accessed after an incident. This is especially important to members assigned to adaptive response units. The apparatus cab should be kept as clean as possible to avoid the transfer of contaminants. Fire companies should carry plastic bags to store and seal contaminated turnouts. This is critical to prevent off gassing in the apparatus cab.

**PHOENIX REGIONAL
STANDARD OPERATING PROCEDURES**

SUPERVISING LESS EXPERIENCED PERSONNEL

M.P. 206.03

09/96-R

Page 1 of 2

The purpose of this procedure is to describe the requirements necessary for supervising less experienced personnel at working incidents.

The integral part of safe operations at an incident site is that the fire company functions as a team, supervised by the company officer. The company officer is responsible for the supervision and welfare of all personnel in his/her company and other fire fighters assigned to his/her supervision.

It is important to recognize that fire fighters gain "experience" at different rates. Experience levels depend upon time on the job, number, type and intensity of past incidents, and the quality of supervision and training that the fire fighter has gained.

It is also important to recognize that inexperienced personnel caught in a hot, smoke-filled environment with zero visibility, or other hazardous or unfamiliar environment, can easily take inappropriate action resulting in injury or death to themselves or others.

With the arrival of a new or less experienced fire fighter to the company, the company officer--and all crew members assume responsibility for the new fire fighter.

For the purpose of this procedure, a "less experienced" fire fighter is defined as:

- A. Probationary fire fighter.
- B. Any member with less than two years total experience assigned to fire fighting duties.

It should be noted that two years fire fighting experience, does not necessarily qualify that individual as experienced. Fire fighters may still require direct supervision.

It will be the responsibility of the company officer to determine the experience level of all fire fighters assigned to his/her company through the following methods:

- Interview: Interview the fire fighter to determine time assigned to fire fighting duties, previous assignments, type and amount of prior experience.
- Evaluate: Evaluate the fire fighters proficiency in hose lays, SCBA, ladder, evolutions, etc. Determine the fire fighter's knowledge of fire fighting and safety procedures. Interview previous company officers on the fire fighter's past performance.
- Training: Provide frequent and appropriate training to improve skill levels and maintain proficiency.
- Follow-up: Provide follow-up evaluation and training. Evaluate the fire fighter's performance at each incident. Interview other fire fighters who worked with the fire fighter.

Those fire fighters determined to be inexperienced will be directly supervised by the company officer or a fire fighter with greater than two years total fire fighting experience.

**PHOENIX REGIONAL
STANDARD OPERATING PROCEDURES**

SUPERVISING LESS EXPERIENCED PERSONNEL

M.P. 206.03

09/96-R

Page 2 of 2

Direct supervision will be required at the moment the fire fighter enters an area that exposes the fire fighter to potential injury or death. Examples include:

- A. Entering a building involved with smoke or fire.
- B. Approaching a potential collapse area.
- C. Potential explosion or flash fire.
- D. Approaching a hazardous materials incident.
- E. Entering an area where hazard line tape is present.
- F. Any other area that could cause injury or death to the fire fighter.

The fact that a fire fighter meets the time in assignment criteria to be an experienced fire fighter does not relieve the supervisor of his/her responsibilities. All personnel at an incident will be supervised by and accountable to a company officer or command officer.

The experienced fire fighter, however, may be permitted, under appropriate and safe circumstances, to function at an incident without direct supervision of a company officer.

**PHOENIX REGIONAL
STANDARD OPERATING PROCEDURES**

RECRUIT TRAINING VEHICULARS

M.P. 206.03A

03/09-N

Page 1 of 3

PURPOSE

The purpose of this procedure is to establish guidelines for the operations of recruit training vehiculars. The Fire Department recognizes that recruit vehiculars is a critical phase of the recruit's training, and allows the recruit to experience the actual work of a firefighter. This is done under the close supervision of Recruit Training Officers (RTOs), and it is conducted prior to the recruit leaving the Training Academy and reporting to his or her first probationary station rotation.

This procedure will also ensure the recruit gets a meaningful experience while maintaining a safe environment and allowing for a good communications link between the Training Academy and the Operations Section of the Fire Department.

COMMUNICATIONS BETWEEN TRAINING AND OPERATIONS

It is critical that the Operations Division is aware of recruit vehicular training and the battalions that this training will be occurring in. In the past, recruit-training companies have added on to incidents and the responding field companies and command officers were not aware of their presence. This can lead to confusion and could be dangerous to the recruits.

The responsibility of notification to Operations of any vehicular training from the Phoenix Fire Department Regional Training Academy (TA) will be the Division Chief of Training. The Division Chief of Training will notify the North, South and West Shift Commanders on all three shifts, via e-mail or telephone, of the dates and times that vehicular training will be conducted.

In addition, the Division Chief of Training will place a notice in the Bucksip and through department e-mail and notify all members of the dates and times that vehicular training will be conducted. This should be done at least one week prior to the date of the training. The training companies should use the vehicle designation of Engines 96 through 99. These vehicle numbers are reserved for the TA and are recognized throughout the automatic aid system as training crews.

The RTOs of the individual training companies will notify the specific Battalion Chiefs of the battalions that the training vehicles will be operating in. For instance, if the vehicular engine will be operating in Station 30's first due, the RTO will notify by phone Battalion 8 and advise the Battalion Chief of the plans to train in that area.

The RTO also needs to contact the captain of the Engine and/or Ladder Company and inform them of the recruit-training vehicle in the area. This will give the assigned Company Officer a heads-up for the training vehicle, and to allow the Company Officer to plan to use the training vehicle in the most safe and positive manner.

If the training company plans to move to another battalion for extended operations, the RTO should call the respective Company Officer and Battalion Chief of the new area and inform them of the vehicular company's plans to operate in their area.

**PHOENIX REGIONAL
STANDARD OPERATING PROCEDURES**

RECRUIT TRAINING VEHICULARS

M.P. 206.03A

03/09-N

Page 2 of 3

RECRUIT COMPANY'S OPERATIONS ON FIELD INCIDENTS

Phoenix Regional Standard Operating Procedures M.P. 206.03 describes in detail the procedure of Supervising Less Experienced Personnel. This procedure should be understood completely by anyone involved in the supervision of recruit training companies. Some of the critical issues regarding recruit-training companies are the following:

- All Command Officers in charge of an incident that has recruit training companies operating on their incident should be careful of assigning the training crew to any dangerous or critical assignment. Remember that these training crews are usually two Company Officers and up to 4 recruits. This may be difficult to closely supervise the recruits while operating in a critical, fast moving assignment.
- The recruit training vehicles should avoid adding themselves on to incident many miles away from their current location. Driving code three many miles through city traffic increases the exposure of both fire personnel and citizens to unnecessary accidents, and the chances of the training vehicle getting on the incident scene in time to perform is low. The RTO may choose to add on and respond Code 2 outside their assigned response area to provide relief for companies working large/long term fires such as recycle or pallet yard fires.

TRAINING OPERATIONS OF AUTOMATIC AID AND NON-MUTUAL AID FIRE DEPARTMENTS

On occasion, recruit training vehicles and crews from other fire departments will operate within the City of Phoenix. This may be done in attempts to have the recruits work in high traffic areas and increase the amount of responses and gain more experience. This is understandable but it must be done through a structured manner.

Any training crews operating inside the City of Phoenix must belong to the Automatic Aid system. This ensures that the recruit personnel and their company officers have training that is compatible with that of Phoenix fire crews. This compatibility will allow for safe and effective fire grounds operations. Any training crews that are from a system that does not follow Regional Standard Operating Procedures (Volume 2) as approved by the Regional Operations Consistency Committee (ROCC) or that is not a member in the Automatic Aid system will not be allowed to operate for training purposes within the City of Phoenix city limits.

Any non-Phoenix training academy vehicular that conforms to the Automatic Aid guidelines may operate within the City of Phoenix boundaries. The Chief in charge of Training for the respective agency should contact the Phoenix Fire Department Training Academy Deputy Chief at least four weeks prior to the commencement of training. The Deputy Chief of the Training Academy will contact the Shift Commanders and request permission for the outside agencies to conduct vehiculars for the desired dates and times. These times and dates will also be placed in the Buckslip and on department e-mail for all members. In addition, the RTOs of the individual training companies will notify the specific Battalion Chiefs of the battalions that the training vehicles will be operating in.

**PHOENIX REGIONAL
STANDARD OPERATING PROCEDURES**

RECRUIT TRAINING VEHICULARS

M.P. 206.03A

03/09-N

Page 3 of 3

The communication of this procedure from Phoenix Fire Department to Automatic Aid departments will be through the Deputy Chief of Training of the Phoenix Fire Department. The Training Chief is aware of the other training programs within the Valley, and has established relationships with the other training chiefs.

For uniformity and recognition, any training vehicles from Automatic Aid fire departments should use vehicle designations that involve the numbers 96 through 99. The vehicle number may utilize the numbers of the respective department, followed by 96 – 99. For example, a Glendale training truck may use Engine 1599. A Tempe training truck may be Engine 2799. Since these numbers are recognized as training trucks, this would increase the chances of all officers identifying the company as a training crew and respond accordingly to this procedure and to M. P. 206.03.

**PHOENIX REGIONAL
STANDARD OPERATING PROCEDURES**

STATION SAFETY

M.P. 206.04

01/93-R

Page 1 of 2

A large percentage of personnel injuries occur while participating in routine activities at or around the station. Most of these injuries could be prevented by observing proper safety practices and adopting a safety conscious attitude.

STATION MAINTENANCE

Many personnel injuries could be avoided through a policy of safety conscious station maintenance.

Efforts should be made to keep apparatus floors free from slippery substances and obstructions; water, oil, hydraulic fluid, etc. should be mopped up whenever accumulations appear, especially on the traffic areas around and between apparatus.

Station floors also must be free of slippery substances. Traffic route areas, hallways, stairs, etc., should be clear of unnecessary obstacles and obstructions.

GROUNDS MAINTENANCE

Safety precautions shall be observed when using power lawn equipment: mowers, trimmers, edgers, etc.

- The blade guard on power edgers and trimmers shall be serviceable and in the proper position for the intended use before operating.
- Safety goggles will be available and shall be utilized to provide eye protection from rocks, twigs and other propelled objects when operating mowers, edgers, etc.
- When trimming or pruning certain trees and bushes, gloves may be necessary to provide adequate hand protection. If gloves are needed, they shall be worn.
- Do not use defective equipment such as ladders with broken rungs, power equipment without the proper safety protection, etc. Repair or replace before use.

LIFTING/PULLING

Utilize the following proper lifting techniques when lifting moderate to heavy objects:

- Use your legs to lift--bend your knees.
- Keep your back straight.
- Do not twist your body while lifting--reposition your feet to avoid twisting.
- To lift heavy objects, get your body as close to the object as possible.
- Use of back support devices if previous back problems.

Heavy objects should ideally be stored at approximately waist level -- to prevent unnecessary lifting.

Do not attempt to lift or carry more than you can easily handle -- if necessary get help!

When you are dragging or raising hose with a halyard from the hose tower, do not pull more than you can pull with relative ease -- if necessary get help!

PHYSICAL FITNESS

One of the main objectives of the Physical Fitness Program is to lessen the frequency and severity of employee injuries by increasing the muscular stress and physical stamina of the body. To fulfill this objective, the intent of the phases and steps of the program must be understood by all participants.

**PHOENIX REGIONAL
STANDARD OPERATING PROCEDURES**

STATION SAFETY

M.P. 206.04

01/93-R

Page 2 of 2

The Physical Fitness Manual, like most Operations Manuals, is intended to be reread periodically.

- Are you doing all aspects of the program in the manner intended?
- Do you follow the program warm-up procedures?
- Do you follow the prescribed exercises as illustrated?
- Do you have a proper attitude and approach toward the program?
- Do you follow prescribed cooling down procedures?
- Do you have proper exercise shoes, etc.?

If you are in doubt about any aspect of the program, reread and follow the manual. It's your body, treat it right.

See Physical Fitness Manual.

**PHOENIX REGIONAL
STANDARD OPERATING PROCEDURES**

OPERATING POWER SAWS

M.P. 206.05

05/93-R

Page 1 of 4

When operating power equipment under emergency conditions, accident potential is high due to adverse operational conditions. A slight miscalculation or sudden unplanned move can result in a serious accident. Performance skill coupled with the use of common sense and the strict adherence to safety procedures can prevent accidents.

PERSONNEL PROTECTION

Full protective clothing shall be worn by those members operating, and by those members in close proximity to the operation of power saws.

The face shield shall be in position to provide eye protection.

To prevent accidents caused by moving belts, gears, chains, blades, etc., it is imperative that operator and guide have their protective clothing completely buttoned up.

OPERATING PROCEDURES

Carry the rescue saw with the engine stopped, the blade frontward and muffler away from your body.

Always carry the chain saw with the engine stopped, the guide bar and saw chain to the rear and the muffler away from your body.

Keep both hands on the control handles when operating the saw. Use a firm grip with thumbs and fingers encircling the saw handles.

Make sure of your footing before operating the saw.

Whenever possible, a team of two firefighters shall perform cutting operations. The firefighter operating the saw (operator) will be assisted and/or guided by the second firefighter (guide). The guide may use the sling in which the saw is carried as a safety harness to guide and assist the operator. (See Illustrations "A" and "B", "Safety Harness")



PHOENIX REGIONAL
STANDARD OPERATING PROCEDURES

OPERATING POWER SAWS

M.P. 206.05

05/93-R

Page 2 of 4

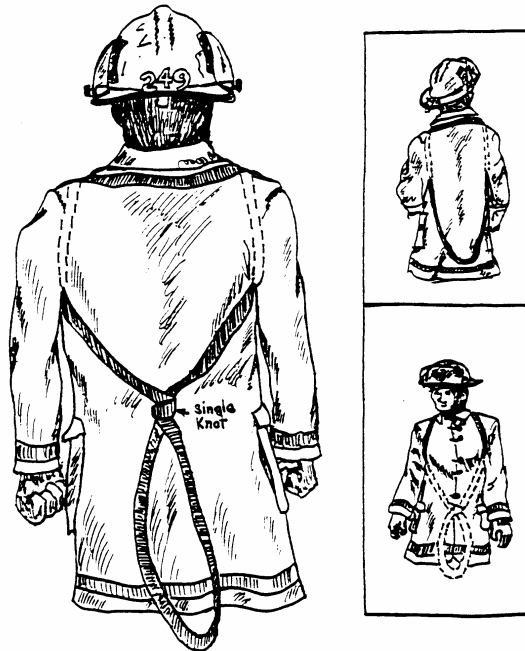

The saw shall always be shut down when unattended.

Have a plan of action before putting the saw into operation; your plan should include:

1. Location and sequence of cuts and openings.
2. Wind direction. Consider its effect on the saw, exposures and personnel.
3. Your plan should provide for at least two (2) means of egress if possible.

Whenever possible, an officer should be present to supervise cutting operations and to assure compliance with safety procedures. The number of personnel should be limited to the minimal number required to sustain the operation. All other personnel shall be removed to a safe location until the operation is complete or assistance with the operation is needed.

Always place the safety guard in the proper position to provide protection for the use intended before operating the saw.

Power saw operations are safest when cutting on horizontal surfaces near ground level or on vertical surfaces near waist level.

Operating a power saw above chest height is extremely hazardous and should not be attempted as a normal course of action. This type of operation shall be conducted only under the direct order and/or under the supervision of an officer. The officer ordering this operation shall weigh heavily the value gained against the extreme hazard to personnel.

The use of a power saw from ladders is not recommended if there are alternatives.

**PHOENIX REGIONAL
STANDARD OPERATING PROCEDURES**

OPERATING POWER SAWS

M.P. 206.05

05/93-R

Page 3 of 4

The carrying strap (safety harness) shall be used to carry a saw while climbing a ladder so that both hands are free to grab the ladder rungs.

Do not operate power saws in suspected flammable/explosive atmospheres.

When operating close to highly combustible materials, use care to prevent ignition from sparks.

Side pressure or twisting of the blade when operating a rescue saw should be avoided. The saw should never be forced. If too much pressure is applied to the blade, the hazard of blade breakage (carbide tipped) or blade shattering (aluminum oxide or silicon carbide discs) is increased. A blade which breaks or shatters during cutting operations may cause serious injury to the operator, or to others in the area.

The saw cut should be only as deep as necessary. Deep cuts may weaken supporting beams and lead to collapse. The experienced operator will know when he has reached a beam by the sound and feel of the saw. The blade guard can be used to control the cutting depth of the blade (rescue saw).

If conditions permit, scrape gravel and debris from the path to be cut, in order to reduce the danger of injury from flying chips and loose materials. (It also will show the operator which way the rafters are running.)

When using the rescue saw to open metal buildings, doors, etc., where conditions permit utilize methods to eliminate the hazards of sharp edges. Consider making your cut in either an X design or a triangular design with the points bent inward. See illustration (c).

FUELING AND MAINTENANCE PRECAUTIONS:

Observe all safety regulations on the safe handling of fuel. When necessary to refuel, comply with the following:

1. The saw should never be refueled while the engine is running.
2. If fuel is spilled while refueling, wipe off saw before starting.
3. Do not operate the saw if there is a fuel leak, send it in for servicing.
4. Do not restart the saw in a small enclosed space after refueling.

Always keep equipment in good, clean, serviceable condition.

Examine the rescue saw cutting wheel for nicks or defects at the beginning of each shift and after each use.

Clean the wheel (blade) and both wheel washers when installing the wheel. Wheel blotters must be used between washers and wheel to compensate for irregularities in the wheel.

Care must be taken to assure that the abrasive saw blades do not become contaminated with petroleum based products. Such contamination may dissolve the resin which is used to bond the blade, causing the blade to shatter when used. New blades should be stored in plastic bags to insure cleanliness.

PHOENIX REGIONAL
STANDARD OPERATING PROCEDURES

OPERATING POWER SAWS

M.P. 206.05

05/93-R

Page 4 of 4

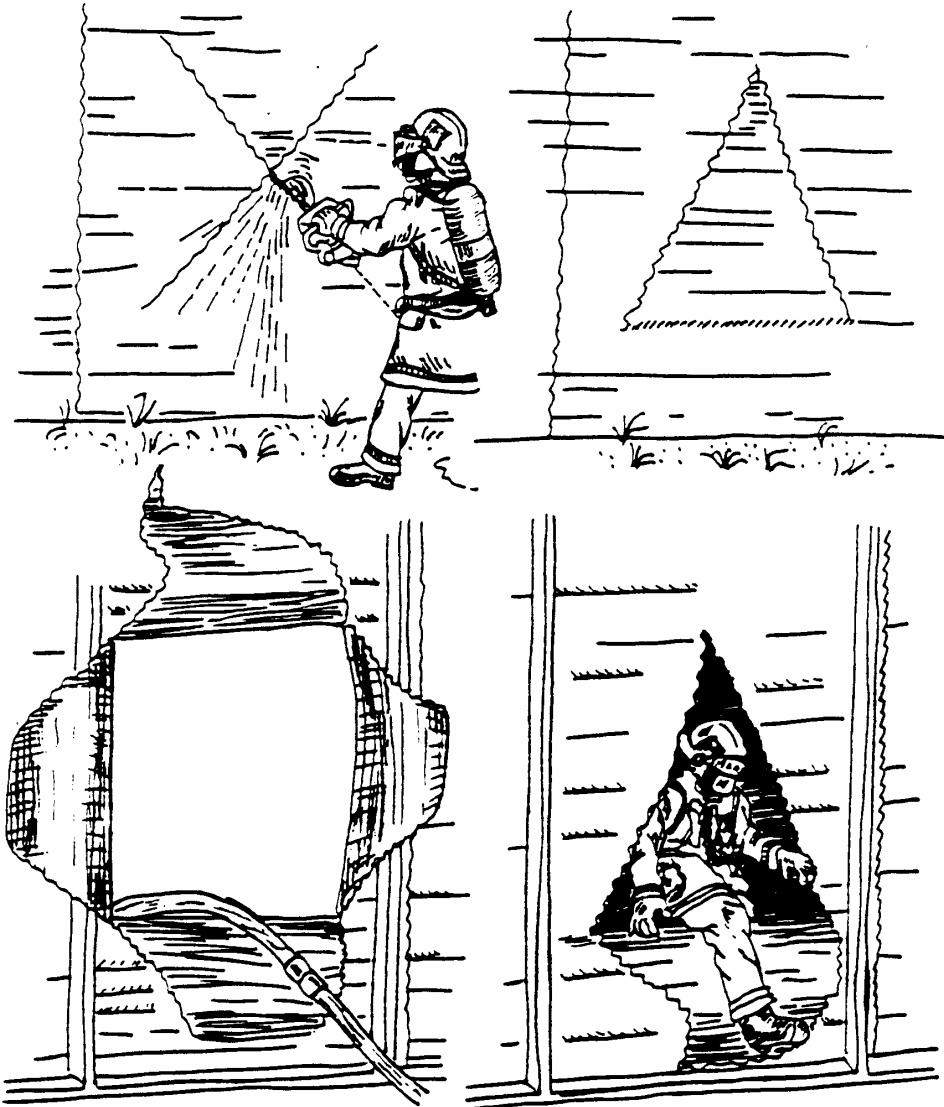

**PHOENIX REGIONAL
STANDARD OPERATING PROCEDURES**

Protective Clothing Inspection Program

M.P. 206.06

05/18

Page 1 of 5

Policy

It is the policy of the Phoenix Fire Department to provide its members with protective clothing and equipment to safeguard them from injury when involved in Fire Department activities. The protective clothing and equipment shall be appropriate for the various activities and services the Fire Department members may provide.

The purpose of these Standard Operating Procedures is to establish a program for structural and proximity firefighting protective coats, pants, hoods, helmets, gloves and boots to reduce the safety and health risks associated with these items when they are poorly maintained, contaminated or damaged.

Scope

This document complies with NFPA 1851 Standard on Selection, Care and Maintenance of Protective Ensembles for Structural Fire Fighting and Proximity Fire Fighting, 2014 Edition.

This document describes the program parts, establishes program procedures and assigns roles and responsibilities to all uniformed members of The Phoenix Fire Department for implementing and maintaining the program.

It is the objective of the program to provide protective ensembles that are appropriate for their intended use.

It is the objective of the program to set requirements for the proper handling, care, maintenance and retirement of protective ensembles.

Program Parts

Phoenix Fire Department has designated personnel who have been trained to provide in-house inspection and services including: (Per NFPA 1851 Standards)

- Advanced Inspection
- Complete Liner Inspection
- Cleaning and Decontamination
- Basic Repairs

**PHOENIX REGIONAL
STANDARD OPERATING PROCEDURES**

Protective Clothing Inspection Program

M.P. 206.06

05/18

Page 2 of 5

Protective clothing inspections will use the following inspection criteria to evaluate the condition of protective clothing. Each item will be rated in at least one of the five categories:

1. New
2. Good
3. Fair
4. Exposed
5. Condemned

Cleaning and decontamination of soiled or contaminated ensemble elements must take place before additional inspection occurs. Cleaning and decontamination are important in maintaining the integrity of the gear and in reducing exposure to carcinogens.

The following elements should be checked as part of a routine inspection:

- Soiling
- Contamination
- Physical damage such as the following:
 - Rips, tears and cuts.
 - Damaged or missing hardware and closure systems.
 - Thermal damage (charring, burn holes, melting, discoloration of any layer).
 - Damaged or missing reflective trim.
 - Loss of seam integrity and broken or missing stitches.

Protective clothing inspections will be conducted at least one time annually, during Battalion turnout cleaning. All members are to inspect their turnouts as part of their daily morning routine and report any issue they may encounter. Each member is responsible for the cleaning, care and maintenance of each set of protective clothing ensemble, and also responsible for obtaining repairs when needed by following established Resource Management procedures.

Contaminated Protective Ensembles will be collected on a daily basis from fire stations with coordination through Resource Management. Resource Management will clean, inspect and repair, if necessary, any documented needs by the member turning in their ensemble. Resource will do their best to get the clean ensemble returned to the member before the start of their next shift.

Resource Management will track and document each set of Protective Ensemble by scanning every set into their database.

Protective ensembles that need to be replaced will be exchanged at Resource Management at the earliest opportunity. An electronic Lost, Stolen or Damaged Report(LSD) will need to be

**PHOENIX REGIONAL
STANDARD OPERATING PROCEDURES**

Protective Clothing Inspection Program

M.P. 206.06

05/18

Page 3 of 5

filled out by the member receiving the new ensemble. To initiate any PPE issue contact Turnout program manager for repair and or replacement at 602-495-5151.

Helmets

Helmets shall be maintained reasonably clean with proper company numbers in place. Face-shield, chin strap, ear flaps and suspension shall be in good condition.

Cleaning:

- Separate shroud (ear/neck protector) from helmet and tag for identification.
- Place shroud in soak tank for 30 minutes, then wash in extractor. Be sure to cover and protect Velcro so it doesn't damage other PPE equipment while washing.
- Spray and scrub with a sponge or light duty cleansing pad with fire departments approved PPE cleaning solutions.
- Thoroughly rinse entire helmet 2-3 times.
- Heavily soiled helmets can be soaked for 30 minutes in soak tank. Then scrubbed with a sponge or light duty cleansing pad if needed.
- Thoroughly rinse entire helmet 2-3 times.
- Helmets shall be air dried.
- Shrouds (ear/neck protector) shall be air dried.
- Properly identify the correct helmet and shroud and reassemble.
- Use a mild detergent with a pH level from 6.0 to 10.5 (look for documentation on detergent that it has been tested for PPE).

Replace:

- Severely stained or split face piece.
- Helmet with visible cracks.
- Helmet which is warped or bubbled from exposure to heat.

NOTE: All items constructed from thermoplastics are susceptible to ultraviolet and chemical degradation. When the helmet loses its surface gloss and the surface begins to flake away, this chemical degradation has occurred. During inspections, helmets will be checked for these conditions and the shell will be replaced immediately if they are evident.

**PHOENIX REGIONAL
STANDARD OPERATING PROCEDURES**

Protective Clothing Inspection Program

M.P. 206.06

05/18

Page 4 of 5

Protective Hoods

- Protective Hoods - Members should utilize the Hood Exchange Program.
- Should be cleaned with NFPA 1851 approved cleaner.
- Hoods that have holes, tears, are stretched out or that have visible burns should be replaced.

Gloves

Cleaning- Should be cleaned with NFPA 1851 approved cleaner.

Replace:

- Stiff or rigid gloves.
- Stitching worn or rotten.
- Glove insulation is worn through.
- Leather split.
- Gloves with holes or tears in them.
- Gloves that do not fit properly.
- Gloves which are not Fire Department approved.

Turnout Coat & Pants Outer shell

Cleaning:

- Separate layers of Garment Ensemble.
- Spot treat heavy soiled areas with approved spotters/cleaners.
- Close all closures on coat and pants (outer shell).
- Load machine to the capacity recommended by machine manufacturer.
- Use a mild detergent with a pH level from 6.0 to 10.5 (look for documentation on detergent that it has been tested for turnouts).
- Wash with machines that have an extract speed of less than 100g force if possible.
- If the machine has programmable cycles, then wash on the appropriate cycle for the element being washed (outer shell vs. liner).
- Remove gear from machine and inspect and rewash if needed.

**PHOENIX REGIONAL
STANDARD OPERATING PROCEDURES**

Protective Clothing Inspection Program

M.P. 206.06

05/18

Page 5 of 5

Repairs:

- All repairs requiring stitching must be made with Nomex thread.
- Broken snaps.
- Rivets pulled loose from fabric and from the objects they secure.
- Suspenders, snaps, and leather eyes which are broken or elongated.
- Stitching missing.
- Holes or rips in shell of garment.
- Frayed or worn collars.
- Ripped liners.
- Reflective stripes which are burned, cracked, melted or torn.
- Wristlets that are torn or stretched.

Replace:

- Coat and pant no longer fits.
- Inspected and does not fit matrix cost for repair.
- Older than 10 years.

Turnout Coat and Pant Liner

- Separate layers of Garment Ensemble.
- Spot treat heavy soiled areas with approved spotters.
- Turn Liner inside out ...close all closures on coat and pants.
- Load machine to the capacity recommended by machine manufacturer.
- Use a mild detergent with a pH level from 6.0 to 10.5 (look for documentation on detergent that it has been tested for turnouts).
- Wash with machines that have an extract speed of less than 100g force if possible.
- If the machine has programmable cycles, then wash on the appropriate cycle for the element being washed (outer shell vs. liner).
- Remove gear from machine and inspect and rewash if needed.
- Note: water temp shall not exceed 105 degrees F.

Boots

- Should be cleaned with NFPA 1851 approved cleaner.
- Boots that are cracked, have holes in them, or don't fit should be replaced.

**PHOENIX REGIONAL
STANDARD OPERATING PROCEDURES**

TANK FARM

M.P. 206.08

01/04-R

Page 1 of 7

The Tank Farm, located southwest of the intersection of 51st Avenue and Van Buren Street and Swissport Fueling at 4200 E. Airlane are major tactical hazards. Due to the degree of the hazards and the complexity of the occupancies involved, it requires special pre-fire planning considerations that are included in this procedure.

The Tank Farm serves as the primary distribution point for petroleum products in the Phoenix area. Most All of these products arrive at the Tank Farm by pipe line or by rail car and are delivered to the tanks operated by various companies and agencies.

Large quantities of products, primarily flammable and combustible liquids, are stored at this location and distributed to service stations and other users by tank truck or through additional underground pipelines.

The incoming pipelines are operated by Kinder Morgan Pipelines, Inc., which also owns and operates most of the main facility. A number of different companies and agencies store and distribute products from adjoining facilities. A piping manifold system provides for the distribution of products among the individual facilities. The central manifold is located on 53rd Avenue in the Kinder Morgan Pipelines yard in the middle of the Tank Farm area.

Kinder-Morgan and Swissport Pipelines

The pipeline system delivers products to the Tank Farm at a high rate of flow. (The incoming flow rate may be up to 6300 GPM.) An operator is on duty 24 hours per day at Kinder-Morgan who can shut down the flow if necessary. In the event of any major spill, including tank overfilling or a ruptured pipe, orders must be given to shut down the pipeline by the on duty operator.

To shut down the pipeline, Command should direct the Dispatch Center to contact Kinder Morgan Pipelines to relay this instruction. The telephone numbers are in CAD. It takes several minutes to fully stop the incoming flow.

A complex system of piping interconnects all of the facilities in the Tank Farm Complex, allowing products to be delivered or transferred. All of these lines connect to the manifold in the Kinder Morgan Pipelines yard. The piping manifold can be used for subsurface foam injection into designated storage tanks.

Swissport operates a 10-inch diameter pipeline that supplies aviation fuel to its tank farm located at 4200 E. Airlane. This pipeline has a flow rate of about 1,200 GPM. The pipeline is routed along 55th Avenue to the Union Pacific railroad right-of-way, through downtown Phoenix, and terminates at Sky Harbor Airport. Swissport can stop the flow of the pipeline from its main terminal at 5555 W. Van Buren or at the Sky Harbor tank farm. Swissport staffs the Van Buren and Sky Harbor Airport tank farms with an operator 24 hours per day.

Loading Racks

Except for Swissport, there are truck loading racks at each facility in the complex. Product is transferred at 700 – 1,000 GPM into tank trucks at these racks. There is a potential for large spills and/or fires if a tank is allowed to overflow or if a line ruptures or becomes disconnected.

**PHOENIX REGIONAL
STANDARD OPERATING PROCEDURES**

TANK FARM

M.P. 206.08

01/04-R

Page 2 of 7

Many of the loading racks have automatic AFFF deluge sprinkler systems which are activated by heat or flame detectors with manual activation provided as back-up. In the event of a large spill at the rack, the deluge system should be manually activated to cover the spill.

The automatic deluge system should be shut down as soon as fire control is achieved. If after the stored foam supply is exhausted, the system will discharge plain water damaging the foam blanket. AFFF handlines should be in position when the system is shut down.

Tank Storage

There are three different categories of large storage tanks in use at the Tank Farm complex:

1. Floating Roof: An open top tank with a floating cover on top of the liquid. (May also be covered by a geodesic dome).
2. Cone Roof: A fixed top tank.
3. Cone/Floating Roof: A tank with both a fixed roof and an internal floating roof

The greatest concern with a tank is the possibility of an overflow spill. Most tanks are equipped with high level alarm systems to reduce the risk of spills.

An ignited overflow spill will result in a major fire in the dike area around the tank as well as a fire at the surface level of the tank.

It is always important to control the spill fire before attempting to control the tank surface fire, since a spill fire would continue to re-ignite vapors coming from the tank. With the spill fire contained, efforts can be made to control the tank surface fire. The spill area must be secured with a foam blanket for the duration of the incident.

A floating roof, when in place, limits the amount of surface available to support a fire. If the floating roof is lost, due to an explosion or sinking, the fire can be expected to intensify rapidly.

Floating roof tanks may experience "rim seal" fires. These fires involve the seal area between the floating roof and the inside wall of the storage tank. The seals are constructed from synthetic rubber or plastic. The seal is about 8-12 inches wide, depending on the type of tank. These fires are generally controllable with small handlines or dry chemical extinguishers. In a cone/floating roof tank, the fire may be contained in the space between the floating roof and the fixed roof, out of the reach of hose streams.

When applying foam, care must be taken to avoid sinking or tilting the "floater." NEVER apply plain water onto a floating roof--it will probably cause the roof to sink.

Entry onto the roof of a floating roof tank can only occur after assessing the risk to our personnel and determining if the roof is constructed using an "inherently buoyant design." Floating roofs that are inherently buoyant are constructed of steel with multiple bulkheads that form liquid tight compartments.

**PHOENIX REGIONAL
STANDARD OPERATING PROCEDURES**

TANK FARM

M.P. 206.08

01/04-R

Page 3 of 7

The position of the floating roof in relation to the top of the tank shell should also be considered. A floating roof that is more than 5 feet below the top of the tank shell constitutes a confined space. If entry onto the roof is being considered as part of the incident strategy, the procedures for confined space operations outlined in M.P. 204.8 should be applied.

Subsurface foam injection, topside fixed foam chambers, and hydro-foam monitor nozzles are the preferred method to control a full surface fire. When an entire tank top surface area is involved, handline streams will not be able to penetrate the thermal column to reach the burning liquid surface. Large volume AFFF master streams are the only alternative to subsurface injection or fixed systems.

Operations Center - Station 34

In the event of a working incident inside the Tank Farm complex, an Operations Center will need to be established and announced. The Shell Oil USA Terminal Office on Van Buren Street would serve as a suitable Operations Center. Representatives of all companies operating within the complex will assemble at this location to be available if any action involving their facilities is necessary and to provide information or advice. The responsible party for the facility involved in the incident will report to the Forward Command Post.

Command will assign a Command Officer and at least one company to the Operations Center. The Operations Center will provide support as directed by Command. Complete sets of site plans, and photographs are maintained at Station 34.

All public contact, including P.I.O., and liaison functions will be conducted at the Operations Center, unless specifically needed at the Command Post. The Command Post will be located in the most appropriate position to direct tactical operations.

The first unit arriving at the scene of an incident at the Tank Farm shall provide the following information in the initial report:

- Specific location - name of shipper involved
- Type of incident - leak, spill, fire or no fire
- Extent of spill, leak or fire

The first unit arriving at the scene of an incident at the Tank Farm shall provide the following information in the initial report:

- Operation of any automatic fire protection, liquid level control or pipeline product delivery systems
- Tank number(s) and location(s)

Command will direct Alarm to notify the 24-hour duty Operator at Kinder Morgan Pipelines of any working incident. If a major leak or spill is involved, the direction must be given to shut down the incoming pipeline flow.

**PHOENIX REGIONAL
STANDARD OPERATING PROCEDURES**

TANK FARM

M.P. 206.08

01/04-R

Page 4 of 7

Dispatch will also notify the responsible party for the involved property to respond. The Tank Farm has a call up system to notify all key personnel to respond to the designated Operations Center.

Initial actions should be directed toward the tactical priorities listed below.

- Action should proceed cautiously
- High level of safety
- Avoid committing personnel to dangerous situations

TACTICAL PRIORITIES

Major incidents at the Tank Farm complex will involve either a leak or a spill of a petroleum product. The situation may or may not involve a fire.

The tactical priorities are:

1. Ensure that company and contract employees are not within a hazardous atmosphere or have the potential to be exposed.
2. Cover the spill with a foam blanket to control fire and/or prevent ignition.
3. Control potential sources of ignition.
4. Have a HAZ MAT unit monitor the foam blanket to determine its effectiveness.
5. Contain the spill or run-off.
6. Identify and control the source of the spill or leak.
7. Maintain foam blanket until product can be picked up.
8. Keep all personnel and vehicles out of the spill area.
9. Maintain an adequate volume of foam solution on scene for the duration of the incident.

NOTE: A large spill can create an extremely large vapor problem and may flash back from ignition sources at significant distances. While covering the spill to suppress vapors, the direction and extent of vapor travel must be determined.

Foam Application

When attempting to control a large flammable liquid fire, the strategy should be to wait until enough foam concentrate to control the fire is on the scene before beginning the attack. If the attack runs out of foam before the fire is controlled, all of the foam will have been wasted. The minimum foam solution supply and the total amount of foam water solution required for each storage tank has been calculated and is available in the Storage Tank Tactical Guidelines contained on Engine and Ladder companies assigned to Stations 34, 44, 24, 21, 4, and BC3.

NOTE: Foam 34 carries approximately 400 gallons of Class A Foam and 200 gallons of Class B Foam. Foam Tanker 34 carries approximately 1,000 gallons of 3% AFFF-6% ATC concentrate. Foam 44 carries approximately 400 gallons of Class A Foam and 200 gallons of Class B Foam. If a fire involves an ethanol tank or other polar solvent, the foam proportioner must be set at 6%.

**PHOENIX REGIONAL
STANDARD OPERATING PROCEDURES**

TANK FARM

M.P. 206.08

01/04-R

Page 5 of 7

Fires which are controllable with the foam supply on hand should be attacked without delay. This applies to most spill fires and tank vehicle incidents. If the fire is too large to be controlled by the initial attack capability, Command should consider a holding action to protect exposures and prevent spread until additional foam supplies can be assembled and prepared for use.

Subsurface Injection: A system of connections is available to pump foam directly into the main piping manifold at the Tank Farm. The connections are located in the Kinder Morgan Pipelines property near the center of the complex. By opening valves and directing the flow, it is possible to direct this flow to designated tank in the complex and accomplish subsurface injection. This can be performed only with Foam 34. The details of the required connections and pre-calculated flow rates for each tank are carried on Foam 34.

Before beginning subsurface injection, it may be necessary to transfer product out of the involved tank to make room for product in the lines that will be pushed ahead of the foam. Company representatives **MUST** be contacted for instructions to transfer any product.

If subsurface foam application is being contemplated the following items should be considered:

- ❑ Subsurface foam injection cannot be used on ethanol or other polar solvents. The polar solvents will absorb the water in the foam.
- ❑ The volume of liquid in the pipeline must be displaced by the foam water solution. Pipeline volumes can vary from 8,000-25,000 gallons depending on their diameter and distance from the subsurface injection manifold.
- ❑ The inlet valve of the storage tank must be open.
- ❑ If the velocity of the foam water solution exceeds 10 feet/second in the pipeline, the water will separate from the foam, making it useless.
- ❑ Depending on the length of the line and the tank height, it may take 30-60 minutes of time from the time that foam water solution is pumped into the injection manifold until it reaches the burning surface of the tank.

Fixed Systems: Fixed piping is provided on certain tanks to provide direct delivery of AFFF, from Foam 34 into the tank. These systems will deliver foam onto the product via topside application at the tank. A Siamese connection is provided to allow the foam lines to be connected.

NOTE: FIXED FOAM SYSTEMS FOR SUBSURFACE SHALL NOT BE USED PRIOR TO CONSULTATION WITH THE RESPONSIBLE PARTY.

The use of these systems may require complicated operations to manipulate valves, drain lines or remove product. These operations require liaison and cooperation with the responsible parties.

Hose Streams: Foam (AFFF) may be applied through 1 1/2 inch handlines from all engine companies. Master stream capabilities are provided by F34 and FT34 as well as airport crash units. Foam 34 has the capability to supply hand-lines and/or master streams, including elevated streams on ladder trucks.

**PHOENIX REGIONAL
STANDARD OPERATING PROCEDURES**

TANK FARM

M.P. 206.08

01/04-R

Page 6 of 7

When using hose streams, caution must be taken to use a large enough line to penetrate the heat of the fire from a safe distance.

Foam Supply

If the foam supply on hand at the incident scene is not adequate for the incident, Command should direct Dispatch to notify Resource Management to begin to assemble a larger supply. This shall be obtained from:

- Truck and Trailer at Station 34 stores 4200 gallons
- Fire Department Warehouse
- Mutual Aid Fire Departments
- Emergency Purchase from vendors

Because of the large foam demands required for ground spill fires, Command should consider assigning at least one company to assist Foam 44 and creating a Foam Sector. The Foam sector is responsible for ensuring that a sufficient volume of foam is available to control the fire and to assist in maintaining a constant supply during foam water solution application. The Foam sector is also responsible for ensuring that enough foam remains on-hand for continuous application if, after extinguishment, fire firefighters must enter into the spill area. At least 50% of the amount of foam required for extinguishment should be maintained available, especially if tank overhaul is required.

Water Supply

The Storage Tank Tactical Guidelines contain water supply data for the tank farm at 51st Avenue/Van Buren. Analysis of the data reveals that the hydrants within the complex may not provide enough water for both tank fire suppression and exposure protection. The public water mains on Van Buren and 51st Avenue have a greater available fire flow. Companies should consider using the public water mains for supplying water for foam-water application and using the hydrants inside the tank farm complex for exposure protection. The use of the water mains on Van Buren or 51st Avenue for foam water application should provide sufficient fire flow for roof collapse or ground fires.

Exposure Protection

When exposure protection is required, large volume water streams should be used for reach and cooling capacity. Water application must be managed to avoid breaking-up foam blankets or increasing the problems of fuel spills.

Steam production should be used as a guide to protecting exposures: If steam is created when water strikes the surface of the tank, the need for protection is indicated. Tanks generally require little protection on vertical surfaces below the liquid level.

Some of the tank farm facilities have fixed monitor nozzles that can be used to apply cooling water onto tanks that require exposure protection. These facilities are identified in the Storage Tank Tactical Guidelines book.

**PHOENIX REGIONAL
STANDARD OPERATING PROCEDURES**

TANK FARM

M.P. 206.08

01/04-R

Page 7 of 7

Valve Protection

Product control valves on the storage tanks are beneficial because they can be used to route liquid from a fire-involved tank to an empty or partially full tank. Failing to protect these valves in the event of a ground spill fire may prevent tank farm personnel from routing liquid from fire exposed or damaged tanks. In the event of a ground spill fire that does not submerge the valve in liquid, a fire stream should be applied to each valve that may be subjected to heat damage. The use of protective streams will protect the operating components of the valves so that they are not damaged.

Utility Control

If disconnecting the electric power is considered as part of the incident tactics, confirm with the tank farm personnel the implications of this act. Disconnecting power can shut down transfer pumps used to remove spilled products at loading racks, cause motor operated valves on storage tanks to close which prevents subsurface foam injection, and disable controls for all the storage tanks.

Traffic Control

One of the more likely events at the tank farms is a spill resulting from an accidentally overfilled tank. Given the volatility of the fuels, a large area may be covered with vapors that can be within their flammable range. Given the location of both tank farms, traffic control should be established early in the incident to limit the potential for vehicles becoming ignition sources.

For the tank farm at 51st Avenue and Van Buren Street, the minimum boundary for traffic control should be 59th Avenue to the West, 51st Avenue to the East, the Union Pacific railroad crossing to the South, and Van Buren to the North. Command should recognize that all of the trucking companies that transport fuel have access cards that control access gates along 53rd and 57th Avenues. These vehicles can access the tank farm area unless the major intersections and roadways surrounding the tank farm complex are blocked.

For the Swissport facility at 4200 E. Airline, the minimum boundary for traffic control should be 40th Street at Airline to the West and Highway 153 between Washington Street and University Drive to the East. The Union Pacific railroad to the North may need to be shutdown, as well as the parts of the Sky Harbor access roads and runways to the South.

**PHOENIX REGIONAL
STANDARD OPERATING PROCEDURES**

POLICE ASSISTANCE/EXPLOSIVE MATERIALS

M.P. 206.09

03/12-R

Page 1 of 3

The purpose of this procedure is to establish guidelines for the dispatch, response, deployment and communications model of Phoenix Fire Department resources and members assisting the Phoenix Police Department with the disposal of explosive materials and/or devices.

In order to provide for the highest level of customer service and to ensure for the safety of officers on scene of an EOD (Explosive Ordinance Disposal) operation, the Phoenix Police Department may request assistance of the fire department for standby medical assistance during special incidents requiring the deployment of the PPD Bomb Squad. These incidents may include "suspicious packages or letters, bomb threats etc. This procedure does not necessarily apply to incidents where injuries have already occurred. When emergency medical stand by is requested by a Phoenix PD Bomb Squad supervisor through Phoenix Fire Alarm, the on duty Car 958 Captain (Terrorism Liaison Officer) and the designated PD TLO should immediately be contacted via telephone or pager to contact the Phoenix Fire Alarm Room. During the majority of EOD operations, the C958 Captain will have already been briefed on the operation prior to Alarm Room personnel being contacted. However, no matter how the request for fire department stand by is obtained, it is **CRITICAL** that information be shared between Phoenix PD, C958 and the on duty Deployment Battalion Chief, in order to maintain situational awareness and to provide adequate resources. There may also be instances when other local, county and State law enforcement agencies will request Phoenix Fire resources to stand by for EOD operations within the City of Phoenix. When these requests are received, the same approach will be followed. The fire department will be requested only after a device and/or materials are discovered and sufficient information/intelligence is gathered by C958 and coordinated through the on duty Deployment Battalion Chief. **NOTE:** anytime Phoenix Fire resources are dispatched, the appropriate Battalion Chief must be contacted and provided situational awareness.

Communications

Due to the critical need for stealth in certain police operations and easy public access to public safety radio communications, all fire department communications on Police EOD incidents will be conducted primarily through C958 on an encrypted radio channel. All pertinent information regarding staging locations, target address, and safety issues will then be relayed to the Company Officer or Command Officer that will be on scene as stand by. This communication can be made prior to the deployment and staging of resources over direct telephone line, MCT and/or face-to-face whenever possible. Units shall avoid any radio traffic in regards to the nature of the incident, address, etc. The Alarm Room TRO and/or Supervisor will also be made aware of this information for accountability and tracking purposes. The Alarm Room shall also make all appropriate notifications. Whenever possible, the C958 Captain and the PD TLO will attend the Bomb Squad briefing where the majority of the information will be shared. If time does not permit for a formal briefing to be conducted, C958 will make contact with the on scene Phoenix PD Supervisor to obtain all necessary information pertaining to the operation. Due to the fact that the C958 Captain is privy to law enforcement sensitive information, only information that is **CRITICAL** to the safety and welfare of fire department personnel on scene should be shared.

Once the "target address" is obtained by C958, he/she will determine a safe and secure staging location for fire resources. C958 will then inform the Alarm Room of the "target address" and request a premise alert for a minimum of one/quarter (1/4) of a mile for the address. This zone will allow for PD evacuation zones and routes, encompasses adjoining neighborhoods, large occupancies (apartment complexes, shopping malls, commercial buildings etc.) and provides a buffer zone for secondary devices. In this instance, it is crucial that the closest Battalion Chief and Shift Commander are notified immediately by the Alarm Room. The premise alert will ensure that no other outside fire resources are dispatched into the location.

**PHOENIX REGIONAL
STANDARD OPERATING PROCEDURES**

POLICE ASSISTANCE/EXPLOSIVE MATERIALS

M.P. 206.09

03/12-R

Page 2 of 3

In the event of an incident being dispatched in proximity to EOD Operations, the Alarm Room will contact C958 to determine if the area is safe for fire department units to continue response. If conditions dictate a response, the closest Battalion Chief should be dispatched to manage the deployment of resources and to interact with PD to provide field force protection. If the on scene Command Officer deems it necessary, upgrading to a Tiered Response should be considered with the Shift Commanders making final determination. The staging location shall be determined by C958 after attending an initial briefing with the Phoenix PD Bomb Squad.

Deployment

The nearest ALS fire company and rescue company will be dispatched to police EOD operations anywhere in the city. Response will be CODE 2 unless Code 3 is requested by C958 via the Alarm Room due to extended response times or critical events that may have unfolded at the EOD operation. The Deployment Battalion Chief and/or supervisor will notify the on duty Shift Commanders and apprise him/her of any situation that changes in complexity or severity.

The C958 Captain will act as the initial Incident Commander on scene and will establish a unified command with the appropriate police department supervisor. **CRITICAL NOTE:** C958 will act as the command and Control component on scene and will provide strategic direction for all fire department resources staged and/or deployed on scene. The main role of the C958 Captain is that of **Liaison** between Phoenix PD and Phoenix Fire resources. In the event that the operation changes in size, complexity and/or severity, C958 shall request appropriate resources and a Command Officer should be requested to assume the Command and Control piece for fire resources. For long-term, low-key situations, C958 has the option to stage fire resources in quarters until the PPD Bomb Squad is prepared to engage in high risk activities. C958 shall keep the Deployment Battalion Chief and/or supervisor apprised of site operations to ensure adequate safety, support and situational awareness. For situations of serious nature or complexity, the on scene Command Officer will assume Fire Command and remain in constant communications via C958, with Police Command. All efforts should be made to establish a single Unified Command location to enhance safety and operations. Should an unforeseen accident (critically injured police officer/civilian) occur during the removal/disposal of the explosive device or material, C958 shall request appropriate resources via the Alarm Room. If a Command Officer is not on scene, the closest Battalion Chief shall be dispatched to coordinate fire department resources. The Deployment Battalion Chief or his/her designee shall make proper notifications, including the on duty Shift Commanders. Level 2 staging shall be considered and strictly adhered to until the area is determined "secure" to enter by Fire Command and under the advisement of the Bomb Squad Supervisor. When feasible, C958 shall also request the response of additional TLO's to assist with on scene Intelligence and Operational activities.

All members on scene of an EOD operation and/or detonation shall adhere to guidelines set forth in the PFD Risk Management Plan. It is crucial that all members maintain situational awareness and be cognizant of the possible presence of secondary explosive devices.

At no time should C958 or any other fire department personnel operate in an active "law enforcement inner perimeter". At NO time will fire department equipment or personnel become directly involved with a search, handling or removal of an explosive device or material.

**PHOENIX REGIONAL
STANDARD OPERATING PROCEDURES**

POLICE ASSISTANCE/EXPLOSIVE MATERIALS

M.P. 206.09

03/12-R

Page 3 of 3

Based on the determination of the PPD Bomb Squad, the device or material may be disarmed on scene of the incident or may be transported to an offsite disposal area. If an offsite disposal location is chosen, C958 and the on scene Command Officer shall evaluate the support functions of the disposal such as (Evacuation, Rehab, Fire/EMS support, Haz Mat etc.)

If the medical standby is to be of a longer than 2 hours, a rotation of companies should be considered. C958 will arrange a relief schedule in cooperation with Dispatch & Deployment.

Special Considerations

Occasionally the PPD Bomb Squad may be called out to assist with a suspicious package that was delivered via the United States Postal Service (USPS). If the package or letter is confirmed NOT to be an explosive device by the Bomb Squad, C958 shall coordinate efforts with on scene Hazardous Materials units, C957 and the Command Officer to assure that proper radiological and nuclear testing have been performed on the package. C958 shall also ensure that the appropriate "Field Safe Survey" is completed. C958 shall ensure that the Public Health Coordinator for the PFD Homeland Defense Bureau is notified as early as possible. The Public Health Coordinator is a critical liaison to the Arizona State Laboratory and the Maricopa County Department of Public Health. This is of great importance due to the fact that once the substance is through the "Field Safe Survey", packaged and delivered to the Arizona State Laboratory; the incident becomes an issue of Public Health (notification, treatment, follow up, etc). State and County public health entities will work in cooperation of the law enforcement investigation. C958 and the Homeland Defense Public Health Coordinator will then assist the responsible Law enforcement agency and the USPS Inspector with maintaining the chain of custody until the package is delivered to the State of Arizona Laboratory for final testing.

NOTE: Occasionally, some County, State and Federal law enforcement agencies may request Phoenix Fire resources to provide medical stand by, as their own special duty hazardous materials squads make entry or perform field tests on suspicious packages. Once a request is received for units through the Phoenix Fire Alarm Room, C958 should be immediately notified and dispatched prior to any resources being dedicated. C958 can then interface with the respective law enforcement agency and determine the proper course of action for the resources being requested. Any information gathered by C958 from the agency can then be shared with the Deployment Battalion Chief and Shift Commanders.

**PHOENIX REGIONAL
STANDARD OPERATING PROCEDURES**

POLICE DEPARTMENT SAU OPERATIONS

M.P. 206.09A

03/12-R

Page 1 of 4

This procedure describes the response, deployment and communications model of fire department companies to a request for assistance from the Phoenix Police Department's Special Assignment Unit (SAU).

In order to provide for the highest level of customer service and to ensure for the safety of officers on scene of an SAU operation, the Phoenix Police Department may request assistance of the fire department for standby medical assistance during special incidents requiring the deployment of the Police Special Assignment Unit (SAU). These incidents may include barricade and hostage situations, serving of warrants, "drop houses" etc. This procedure does not necessarily apply to incidents where injuries have already occurred. When emergency medical stand by is requested by a Phoenix PD SAU supervisor through Phoenix Fire Alarm, the on duty Car 958 Captain (Terrorism Liaison Officer) and the designated PD TLO should immediately be contacted via telephone or pager to contact the Phoenix Fire Alarm Room. During the majority of SAU operations, the C958 Captain will have already been briefed on the operation prior to Alarm Room personnel being contacted. However, no matter how the request for fire department stand by is obtained, it is **CRITICAL** that information be shared between Phoenix PD, C958 and the on duty Deployment Battalion Chief, in order to maintain situational awareness and to provide adequate resources. There may also be instances when other local, county and State law enforcement agencies will request Phoenix Fire resources to stand by for SAU operations within the City of Phoenix. When these requests are received, the same approach will be followed.

Communications

Due to the critical need for stealth in certain police operations and easy public access to public safety radio communications, all fire department communications on Police SAU incidents will be conducted primarily through C958 on an encrypted radio channel. All pertinent information regarding staging locations, target address, and safety issues will then be relayed to the Company Officer or Command Officer that will be on scene as stand by. If the Company Officer's BC has not been dispatched, he/she must be notified and briefed on all pertinent information. This communication can be made prior to the deployment and staging of resources over direct telephone line, MCT and/or face-to-face whenever possible. Units shall avoid any radio traffic in regards to the nature of the incident, address, etc. The Alarm Room TRO and/or Supervisor will also be made aware of this information for accountability and tracking purposes. The Alarm Room shall also make all appropriate notifications. Whenever possible, the C958 Captain and the PD TLO will attend the SAU briefing where the majority of the information will be shared. If time does not permit for a formal briefing to be conducted, C958 will make contact with the on scene Phoenix PD Supervisor to obtain all necessary information pertaining to the operation. Due to the fact that the C958 Captain is privy to law enforcement sensitive information, only information that is **CRITICAL** to the safety and welfare of fire department personnel on scene should be shared.

**PHOENIX REGIONAL
STANDARD OPERATING PROCEDURES**

POLICE DEPARTMENT SAU OPERATIONS

M.P. 206.09A

03/12-R

Page 2 of 4

Deployment

The nearest ALS fire company and rescue company will be dispatched to police SAU operations anywhere in the city. Response will be CODE 2 unless Code 3 is requested by C958 via the Alarm Room due to extended response times or critical events that may have unfolded at the SAU operation.

The Deployment Battalion Chief and/or supervisor will notify the on duty Shift Commanders and the appropriate BC to apprise them of any situation that changes in complexity or severity.

The C958 Captain will act as the initial Incident Commander on scene and will establish a unified command with the appropriate police department supervisor. **CRITICAL NOTE:** C958 will act as the Command and Control component on scene and will provide strategic direction for all fire department resources staged and/or deployed on scene. The main role of the C958 Captain is that of **Liaison** between Phoenix PD and Phoenix Fire resources. In the event that the operation changes in size, complexity and/or severity, C958 shall request appropriate resources and a Command Officer should be requested to assume the Command and Control piece for fire resources. For long-term, low-risk situations, C958 has the option to stage fire resources in quarters until SAU is prepared to engage in high risk activities. C958 shall keep the Deployment Battalion Chief and/or supervisor apprised of site operations to ensure adequate safety, support and situational awareness. For situations of serious nature or complexity, the on scene Command Officer will assume Fire Command and remain in constant communications via C958, with Police Command. All efforts should be made to establish a single Unified Command location to enhance safety and operations.

At no time should C958 or any other fire department personnel operate within an active “law enforcement inner perimeter”. Inner perimeter activities are extremely dynamic and fast moving with the potential to escalate quickly. An inner perimeter is defined as a forward and isolated zone where law enforcement officers are in tactical positions with protective gear and weapons engaged and their primary purpose is mitigating a hostile and/or violent incident or suspect.

On-Site Operations

Responding companies will stage in a safe location from the scene, outside the Police control perimeter, and out of the line of any possible gun fire. Once the “target address” is obtained by C958, he/she will determine a safe and secure staging location for fire resources. C958 will then inform the Alarm Room of the “target address” and request a premise alert for a minimum of one/quarter (1/4) of a mile for the address. This zone will allow for PD evacuation zones and routes, encompasses adjoining neighborhoods, large occupancies (apartment complexes, shopping malls, commercial buildings etc.) and provides a buffer zone for active shooter scenarios. In this instance, it is crucial that the closest Battalion Chief and Shift Commander be notified immediately via the Alarm Room. The premise alert will ensure that no other outside fire resources are dispatched into the location. In the event of an incident being dispatched in proximity to SAU operations, the Alarm Room will contact C958 to determine if the area is safe for fire department units to continue response. If conditions dictate a response, the closest Battalion Chief should be dispatched to manage the deployment of resources and to interact with PD to provide field force protection. If the on scene Command Officer deems it necessary, upgrading to a Tiered Response should be considered with the Shift Commanders making final determination.

**PHOENIX REGIONAL
STANDARD OPERATING PROCEDURES**

POLICE DEPARTMENT SAU OPERATIONS

M.P. 206.09A

03/12-R

Page 3 of 4

If the medical standby is longer than 2 hours, a rotation of companies should be considered. C958 will arrange a relief schedule in cooperation with Dispatch & Deployment.

Additional Resources

The Rehab Unit may be dispatched to the Fire staging location, Code 2 if requested by C958 or the Command Officer on the scene. Personnel assigned to the Rehab Unit will contact C958 or the IC on scene and work under their direction. The Rehab unit will remain on-site unless needed for a more significant incident elsewhere. Phoenix PD also utilizes the services of Phoenix Fire CR Vans occasionally. CR Van personnel are utilized for assisting with families, customers or "crime victims" that may be impacted by the SAU operations. In the event that a CR Van is requested to respond to the scene by PD, C958 will be their point of contact to ensure the scene is secure. **At no time should CR Van personnel be dispatched to an SAU operation without C958 knowledge and/or advisement.**

Safety

Fire department deployment to SAU operations is for standby medical assistance only should a police officer or civilian be injured. **Fire personnel WILL NOT become directly involved in law enforcement assault operations. Fire personnel WILL NOT enter an area that is not secure and/or safe to enter.** If the area is not safe, the police department may have to deliver the patients to Fire personnel at the perimeter. The safety of the scene should continually be assessed by C958 and any Company/Command Officer that is on scene.

Occasionally, SAU personnel may make special requests for equipment that fire department units have access to (ladders, TIC cameras, forcible entry tools etc). These requests should be considered on a case by case basis and units will cooperate if the request is appropriate, after consulting with C958 and the Battalion Chief.

Should an unexpected event occur (i.e., sudden unexpected gunfire injuring a person), C958 or Command Officer will request the appropriate additional resource (i.e., additional rescue, 2-1 medical, etc.). All efforts should be made to ensure that units respond and stage to a safe staging location away from SAU operations, prior to entering the scene. When feasible, C958 shall also request the response of additional TLO's to assist with on scene Intelligence and Operational activities.

Should a planned assault be scheduled by SAU, the appropriate stand by resources should be requested prior to the assault action. Coordination of these resources should be handled by C958 in cooperation with the Deployment Battalion Chief.

**PHOENIX REGIONAL
STANDARD OPERATING PROCEDURES**

POLICE DEPARTMENT SAU OPERATIONS

M.P. 206.09A

03/12-R

Page 4 of 4

Out of Jurisdiction SAU Operations

Due to the fact that Phoenix PD officers have state-wide jurisdiction, Phoenix PD SAU occasionally will engage in operations (search warrants) outside the City of Phoenix. In the event this occurs, the SAU Supervisor may request that fire department resources be coordinated with that respective jurisdiction, utilizing C958 as the Liaison. C958 will make efforts to contact the agency's TLO (if applicable) and coordinate the appropriate medical response. C958 has the option to respond with the PD TLO out of the City to assist with coordinating the fire resources for Phoenix PD SAU. Once an SAU operation is planned in another jurisdiction and fire resources will be utilized for medical stand by, C958 shall communicate this to the Deployment Battalion Chief. The respective Command Officer (Operations) and TLO for that agency should also be contacted and made aware of the operation.

Some SAU operations may also occur outside the reaches of the Valley-Wide Automatic Aid Region, which is the responsibility of the Phoenix Fire Alarm Room. If SAU operations are planned in these locales, C958 will advise the SAU supervisor that the standard medical stand by that is normally available, may not be available in these distant jurisdictions. C958 will still make efforts to contact local fire/EMS providers and act as a Liaison between SAU and these local agencies. C958 may also consider placing a medical helicopter (Ranger 41, Native Air etc.) on stand by if feasible. Helicopter standby will be coordinated between the Authority Having Jurisdiction (AHJ) and the Phoenix Fire Alarm Room. In addition, C958 and the AHJ shall work together to establish an appropriate Landing Zone.

Due to limitations in communications, interoperability and consistency in out of region SOP's regarding medical helicopter operations, the responsibility should be upon that of the home fire/EMS agency to coordinate Command/LZ responsibilities. C958 will continue to function as the Liaison between the agency and Phoenix PD SAU and assist with direction as conditions dictate. Except in extreme circumstances (critically injured police officer) and in a designated "secure" treatment sector, C958 should refrain from initiating treatment. Initial medical care should be initiated by the home fire/EMS agency and when available, Phoenix PD EMT's assigned to SAU entry teams.

CRITICAL NOTE: It is NOT the standard practice to dispatch and deploy Phoenix Fire Department ALS/BLS units and rescues outside the Automatic Aid system. Requests for PFD units to respond outside the Automatic Aid system will be made through the Phoenix Fire Deployment Battalion Chief along with coordination from the on duty Shift Commanders. Phoenix PD SAU supervisors should be made aware of limitations when operating under these conditions and locations.

**PHOENIX REGIONAL
STANDARD OPERATING PROCEDURES**

YOUTH FIRESETTERS INTERVENTION PROGRAM

M.P. 206.10

02/01-R

Page 1 of 4

DESCRIPTION OF PROGRAM

The Phoenix Fire Department's Youth Firesetter Intervention Program has taken a positive approach in its efforts to stop youth firesetting. A goal to stop firesetting in our community by youths has been established. Assistance and support to the community is being offered. This is accomplished through investigation, identification, assessment, evaluation, education, and appropriate referral to mental health services described in the following M. P.

ENTRY INTO PROGRAM

Field Captain

If a youth firesetter is identified at the fire scene, the Field Captain can forward an electronic referral via the fire intranet or complete a Youth Assistance Referral form 91-57D which should be carried on each apparatus at all times. This form is then forwarded to the Youth Firesetter Intervention Program in Urban Services. A follow-up letter will be returned to the referring person via email.

If evidence at the fire scene (witnesses, type of fire, etc.) indicates a youth started the fire, the Captain must report this youth firesetter involvement on the Incident Encounter Form.

Station walk-ins

If a family comes to a fire station with their children who have been involved with firesetting, contact the Youth Firesetter Intervention Program; office hours are from 8:00 a.m. to 5:00 p.m., Monday through Friday, phone 602-262-7757. If the situation appears to be a crisis, contact the Alarm Room for an appropriate referral.

NOTE: TOURS OF THE FIRE STATION ARE INAPPROPRIATE AT THIS TIME. This tends to be viewed by children as a reward for negative behavior of setting fires.

When to Call an Investigator

Fire Captains should call an investigator any time there is evidence of arson. If there are witnesses and/or suspects at the scene with information that could identify the youth firesetter.

Also, request an investigator if the fire is of unknown origin or the cause cannot be determined. If the fire was set intentionally and the child is 8 to 18 years old an investigator needs to be notified. A referral to the Juvenile Court Center will be made if the youth is charged with a misdemeanor or felony. The court will mandate the youth to the diversion program for first time offenses. This program consists of two components: fire safety education and consequences of firesetting, along with seven sessions of counseling. Youth charged with felony arson or repeat offenders will be referred to the Maricopa County Attorney's Office for prosecution.

When the investigator determines the fire was accidental due to curiosity, experimentation or negligence and was not intentionally set, the youth is typically not referred to the Juvenile Court Center. The investigator will make a referral to the Youth Firesetter Intervention Program and the family will attend the Youth Fire Safety Class on a voluntary basis.

**PHOENIX REGIONAL
STANDARD OPERATING PROCEDURES**

YOUTH FIRESETTERS INTERVENTION PROGRAM

M.P. 206.10

02/01-R

Page 2 of 4

Family Referral

When a family is referred to the Youth Firesetter Intervention Program, a phone interview is conducted to determine the severity of the problem. If the child is curious or experimenting with fire, a referral is made to the Youth Fire Safety Class. In addition, if the problem seems to be a crisis situation, a referral is made to a mental health professional. The family is sent an invitation to the Fire Safety Class along with some information on fire safety.

INTERVENTION STRATEGIES

Youth Fire Safety Class

The class is held one Saturday or one Thursday night a month at a Phoenix Fire Department facility. A Youth Firesetter Intervention Program team member instructs the class. The morning classes are held from 9:00 a.m. to noon for children ages 3 through 7. The preschool class is for children 3, 4, and 5. The 6 and 7-year-olds attend a separate class. Both morning classes teach fire safety behaviors.

The afternoon class is held from 1:00 to 4:00 p.m. for youth ages 8 through 12. This class addresses the consequences of firesetting as well as responsibility issues incurred with firesetting. All classes are available at no cost to the family and are voluntary. Parental attendance is strongly recommended. The Thursday evening class is held from 6 to 9 p.m. for youths 8 through 17 years of age. The class addresses the consequences of firesetting as well as the responsibilities incurred with firesetting. In this class the students discuss Arizona Arson and Fireworks Laws, and the definitions for felony and misdemeanor.

Counseling

If the family is experiencing a severe problem with firesetting, the caseworker will refer them to a mental health professional. The counseling component consists of at least seven sessions. The provider will work with the client to investigate existing insurance. If no mental health insurance is available through the client, budgeted funds from the Phoenix Fire Department will be used. These visits are voluntary.

Diversion Program

When an investigator makes a referral to the Juvenile Court Center and the youth is charged with a misdemeanor, he/she may be eligible for the diversion program for first time offenders. This program consists of a three-hour class on the third Thursday of each month. A Youth Firesetter Intervention Program team member teaches the class. The primary focus of the class is on consequences of firesetting; i.e., life and property, misdemeanors, felonies and the effects on the fire service.

The youth is also referred to a mental health professional for at least seven sessions of counseling mandated by the Juvenile Court Center. Both components must be completed for credit. Youths charged with felony arson crimes and/or repeat offenders are not eligible for the diversion program and will be referred to the Maricopa County Attorney's Office for prosecution.

**PHOENIX REGIONAL
STANDARD OPERATING PROCEDURES**

YOUTH FIRESETTERS INTERVENTION PROGRAM

M.P. 206.10

02/01-R

Page 3 of 4

COMMUNITY SUPPORT

Community Advisory Panel

This group meets on a quarterly basis to discuss the problems of youth firesetting throughout the community. Their main objective is to reduce firesetting and make other agencies aware of the program. This group involves Child Protective Services, police, Juvenile Court Center, schools, mental health providers, burn center representatives, insurance companies, etc.

Urban Survival

The Urban Survival curriculum is utilized in many schools throughout Phoenix. Often, the Community Education Specialists (Fire Pals), along with school staff, have contact with firesetter's. The curriculum includes an explanation of firesetters and information for further assistance regarding entry into the Youth Firesetter Intervention Program.

PROGRAM PARTICIPANT'S RESPONSIBILITIES

FIRE MARSHAL

Oversees all programs in the Division of Urban Services.

PROGRAM MANAGER

Manages all elements of the Youth Firesetter Intervention Program. Is greatly involved with the community. Seeks grants to fund the mental health component.

DEPUTY CHIEF - INVESTIGATIONS

Oversees referrals from Fire Investigators to the Youth Firesetter Intervention Program. Works with the Program Manager to provide ongoing training.

DEPUTY CHIEF - COMMUNITY INVOLVEMENT

Supervises all elements of the Youth Firesetter Intervention Program. Interacts with and supports the Community Advisory Panel.

FIRE INVESTIGATOR

Responds to youth set fires when requested by a Fire Captain. Has the power to arrest if the fire was set knowingly, with intent, and the youth is between the ages of 8-18; a referral will be made to the Juvenile Court Center.

**PHOENIX REGIONAL
STANDARD OPERATING PROCEDURES**

YOUTH FIRESETTERS INTERVENTION PROGRAM

M.P. 206.10

02/01-R

Page 4 of 4

YOUTH FIRESETTER INSTRUCTOR

Trained personnel are responsible for teaching the scheduled Youth Firesetter Intervention classes outlined in Section III, which include the Youth Fire Safety Class and Juvenile Court Center Diversion Program. The Instructor attends training sessions, which include quarterly meetings, and seminars.

They are also involved in updating and improving ongoing Youth Firesetter Intervention Program curriculum, new teaching techniques, and materials.

CASEWORKER

The caseworker receives and processes all referrals regarding juvenile firesetters. An intake form is completed over the phone with the family to determine the severity of the problem. Referrals are then made to an educational class and/or to a mental health professional for counseling. The caseworker also works with the Public Education Specialist to update and improve Youth Firesetter Intervention Program curriculum, new teaching techniques and materials.

PHOENIX REGIONAL
STANDARD OPERATING PROCEDURES

EMERGENCY FOSTER CARE

M.P. 206.11 10/96-R Page 1 of 1

It may be necessary, under some circumstances, for the fire department to arrange for temporary foster care for children. This could occur in the case of a fire or any situation in which parents, relatives or legal guardians are unable to provide care and/or shelter for the children.

In these cases, Dispatch shall be requested to make contact with the Arizona Department of Economic Security - Protective Services Division. Protective Services will designate the proper location to deliver the children, depending on the circumstances.

The Phoenix Police Department must be advised any time that children are placed with Protective Services. The Police Department can usually provide the needed transportation for the children.

**PHOENIX REGIONAL
STANDARD OPERATING PROCEDURES**

HYDRAULIC RESCUE TOOL

M.P. 206.13

05/93-R

Page 1 of 1

Full protective clothing shall be worn by those members operating, or in close proximity to the operation of the Hydraulic Rescue Tool.

The fluid used to operate the Rescue Tool can cause damage to the eyes. To provide eye protection, allowing for the event of a hose or coupling failure where fluid could be expelled, all members in the area of operation of a Rescue Tool shall place their face shield in the down position to provide for such protection. Full protective clothing should be worn when operating the rescue tool.

NOTE: SHOULD FLUID GET INTO THE EYES, THE EYES SHOULD BE FLUSHED IMMEDIATELY WITH COPIOUS AMOUNTS OF WATER AND THAT PERSON SEEK MEDICAL ASSISTANCE.

Precautions shall be taken to protect the trapped and injured from further injuries during the operation (i.e. sparks, propelled objects, flying glass, etc.), and a charged 1-1/2" foam hoseline in place, manned by personnel in full protective clothing.

The Hurst Tool engine should be kept away from the injured and placed down wind of the work area. It must not be placed where it would provide a source of ignition for any flammable vapors in the air.

**PHOENIX REGIONAL
STANDARD OPERATING PROCEDURES**

AFRICANIZED HONEY BEES

M.P. 206.14

05/21-R

Page 1 of 2

POLICY

The Fire Department does not exterminate bees. The Fire Department will deploy units to rescue and/or treat victims of an Africanized Honey Bee (AHB) attack. The purpose of this procedure is to outline a process by which fire companies will approach and manage an AHB attack.

DISPATCH

When the Dispatch Center receives a call for AHB attack, two fire department units (one being an ALS engine company and one ladder company) and a Battalion Chief should be dispatched. They shall proceed Code III to the scene and arrive being careful not to commit themselves in the path of the source of bees, approximately 150 feet from the colony.

ON-SCENE

Upon arrival at an AHB incident site, a rapid evaluation should be made by the first arriving Company Officer and the following activities implemented:

- Determine if there are any victims which will require rescue and/or medical treatment.
- Designate a Level II staging area for subsequent arriving fire department units and/or other agencies which are also responding.

Once on the scene, three crew members shall don full structural firefighting personnel protective equipment (PPE) including SCBA. Ankles and waist should be taped tight to prevent bees from crawling up the chest or legs. If firefighters have Bee PPE, they may wear this in place of structural firefighting PPE.

APPROACH

A quick attack 1 ¾ inch hose line shall be pulled by the firefighter at a quick pace towards the affected patient(s). A fog pattern on the nozzle should be used, sweeping the air surrounding the firefighters and patient. The patient should be quickly picked up while at the same time sweeping the surrounding air with the hose line. The hose line should continue to be sprayed to keep the bees off the firefighters and the patient when retreating to a safe distance approximately 150 feet from the swarm. At this time, it should be reevaluated if the area retreated to is far enough away to begin more definitive treatment of the patient. Class A firefighting foam may be used at the highest concentration possible as it has been found to assist in allowing water to adhere to the bees.

**CLASS B FIREFIGHTING FOAMS CONTAINING PERFLUOROALKYL OR POLYFLUOROALKYL
SUBSTANCES (PFAS) SHOULD NOT BE USED.**

**PHOENIX REGIONAL
STANDARD OPERATING PROCEDURES**

AFRICANIZED HONEY BEES

M.P. 206.14

05/21-R

Page 2 of 2

RECEIPT AND PROCESSING OF CALLS FOR ASSISTANCE

Upon receipt of a call for an AHB incident the call taker shall solicit information from the calling party to determine appropriate action. Information gathered shall include:

- Location of incident
- Call back number
- Has anyone been stung or is anyone being stung now, and the number of persons involved.
- Is the incident in close proximity (200 feet or less) to a school, day care center or other building with numerous occupants, especially children?
- Name and address of school, day care center, or other building if applicable.
- Specific location of the bees (i.e., in drain pipe in alley; in barbecue pit in back yard; in mail box in front of home).

If the incident is in close proximity to a school, day care center, or other building with numerous occupants, the school principal, day care owner, building manager, etc., shall be contacted and advised to keep all building occupants indoors and to close all external openings until the AHB incident is terminated.

**PHOENIX REGIONAL
STANDARD OPERATING PROCEDURES**

Toxic Exposure Investigations Program

M.P. 206.16

01/19

Page 1 of 3

Policy

It is the policy of the Phoenix Regional Fire Department to investigate and document all known or suspected toxic exposures. The Phoenix Fire Department Health Center will collect all data and maintain records of all exposures. The designated Certified Industrial Hygienist to the Phoenix Fire Department will be responsible for the collection of all samples and communication with the appropriate laboratory on their findings.

Toxic Exposure Forms are located on every station computer on Fire Point, or can be accessed on personal/mobile devices at <http://cityofphoenix.sharepoint.com/sites/fire>.

Purpose

The purpose of the investigation and reporting of toxic exposures is to document all known and unknown substances that a member may have been exposed to on any given incident. In cases where a member's health is affected by toxic substances, the documentation and laboratory findings will be used to support the evidence of possible adverse health effects.

Contents

Incident number, time, date, location, and business/occupancy name: This data is to be filled out from the corresponding dispatch information. Inaccurate information must be corrected as soon as possible or notified to the Toxic Exposure Officer.

Incident Type: Select the appropriate category. If any unusual circumstances exist, fill out the *Other/Describe* section as accurately as possible.

Chemicals involved in incident: Obtain from on-scene Command, Haz Mat sector, or C957 N/S. List chemicals from Material Safety Data Sheet (MSDS), or bill of lading.

Units exposed: Obtain from incident history. List all units.

Lab results: These forms may not be readily available until the laboratory or the Industrial Hygienist completes all testing and findings are completed. Once the results are received by the Toxic Exposure Officer, those reports will be filed and stored at the Phoenix Fire Department Health Center. Electronic Toxic Exposure forms on Share Point will then be updated to include these results to each member's report by the Toxic Exposure Officer.

**PHOENIX REGIONAL
STANDARD OPERATING PROCEDURES**

Toxic Exposure Investigations Program

M.P. 206.16

01/19

Page 2 of 3

Toxic Exposure Reporting

Phoenix Regional Fire Department members who are exposed to known or suspected toxic substances during the performance of work duties must contact the Toxic Exposure Officer. The Toxic Exposure Officer will initiate the toxic exposure investigation.

On all incidents where personnel are exposed, a minimum of the Toxic Exposure Form shall be completed. In an exposure incident where personnel feel symptomatic, they shall follow the Toxic Exposure Notification process below.

Toxic Exposure Notification

When personnel are exposed to toxic substances, whether known or suspected, Dispatch and Deployment, along with their Immediate Supervisor should be contacted immediately so that the investigation can be initiated at the time of the exposure and at the incident location of the exposure. Dispatch will then notify the Toxic Exposure Officer.

Due to the type of exposure, and the probability of multiple employees becoming exposed, the TEO will communicate with Car 957 and Command at the incident.

The Toxic Exposure Officer will be responsible for gathering information as it comes available to him/her, and shall be included in his/her findings in the report.

Notification of all employees exposed will be made as soon as possible. All exposed employees shall fill out a Fire Personnel Toxic Exposure Report located on Fire Point.

Symptomatic exposed personnel shall be transported to the Phoenix Fire Department Health Center or to Banner University Medical Center Phoenix (depending on severity) for evaluation and treatment. Consider the availability of hyperbaric chamber therapy at Banner University Medical Center Phoenix for members with known or suspected smoke inhalation.

Notification should be made to Car 959 in instances where members are transported to a hospital. The Car 959 Officer can serve as liaison between the TEO and hospital staff.

**PHOENIX REGIONAL
STANDARD OPERATING PROCEDURES**

Toxic Exposure Investigations Program

M.P. 206.16

01/19

Page 3 of 3

Documentation of Exposure

The Toxic Exposure Officer is responsible for conducting an investigation and completing a report in conjunction with the Certified Industrial Hygienist designated to the Phoenix Fire Department. The investigation will also consist of sample collection at the incident performed by the Certified Industrial Hygienist and may be assisted by the Hazardous Material Team if proper PPE is required. The Toxic Exposure Officer or designee can special call a hazardous materials unit to conduct sample collecting if the nature of the incident so dictates it. The Certified Industrial Hygienist will determine what types of samples to collect and then be responsible for getting the samples to a lab for analysis. The Certified Industrial Hygienist will have a sample collection kit that will be given to the hazardous materials team for the collection of samples. Each sample will be identified with an identification number and categorized appropriately. Location, time and date of sample collection will also be documented by the Toxic Exposure Officer or Certified Industrial Hygienist. Once the data is collected and the sample analysis is received from the lab, the Toxic Exposure Officer will add the results to each members Toxic Exposure Form and file the results in the archives at The Phoenix Fire Department Health Center.

**PHOENIX REGIONAL
STANDARD OPERATING PROCEDURES**

TRACKING OF ASYMPTOMATIC BIO- EXPOSURE PATIENTS

M.P. 206.16A 07/03-N Page 1 of 2

POLICY

It is the policy of the Phoenix Fire Department to provide the best possible care to all patients encountered. It is anticipated that most events involving biological agents will not generate a scene to which personnel could respond. This is the case because biological agents are slow acting and the public health surveillance systems may require days to detect patterns of causalities. It is also possible in a biological incident that victims at the scene may exhibit no symptoms.

PURPOSE

The purpose of the bio-exposure information card is to capture information that may be used in epidemiological tracking. A copy of the bio-exposure information card is contained on page 2 of this procedure. The bio-exposure information card when completed will contain the following information:

Front of card

Date of incident
Victim name, address, phone number(s)
Destination from scene
Symptomatic/EMS evaluation (Y or N)

Back of card

Date of incident
Probable exposure
Location of exposure
Notification of MCDPH*
Arrival/Departure airline
(If airport incident)

PROCEDURE

If the medical decision is to allow *asymptomatic* victims to leave the scene or there are victims that are demanding to leave the scene, a bio-exposure card will be completed prior to their departure from the scene. In the event that the scene is at Sky Harbor, the cards will be collected from *all* passengers who arrive on aircraft where (1) there is evidence of or (2) credible reason to suspect exposure has taken place. Completed bio-exposure cards will be forwarded via interoffice mail to EMS/Public Health Programs Manager. Copies of the cards are to be provided to MCDPH* and Epidemiology Section of the AzDHS**.

RESPONSIBILITIES

Bio-exposure information cards are available for use on all apparatus. Reorder of cards through information services via the district offices.

* MCDPH is Maricopa County Department of Public Health

**AzDHS is Arizona Department of Health Services

**PHOENIX REGIONAL
STANDARD OPERATING PROCEDURES**

TRACKING OF ASYMPTOMATIC BIO- EXPOSURE PATIENTS

M.P. 206.16A 07/03-N Page 2 of 2

FRONT OF BIO-EXPOSURE INFORMATION CARD

PHOENIX FIRE DEPT BIO-EXPOSURE INFORMATION CARD (front)

DATE OF INCIDENT: _____

NAME: _____

STREET _____

CITY _____ STATE _____ ZIP _____

PHONE(S) () _____ () _____

DEPART PHX / SCENE TO _____

SYMPTOMATIC YES NO

EMS EVALUATION YES NO

BACK OF BIO-EXPOSURE INFORMATION CARD

PHOENIX FIRE DEPT BIO-EXPOSURE INFORMATION CARD (back)

DATE OF INCIDENT _____

PROBABLE EXPOSURE _____

LOCATION _____

MARICOPA COUNTY HEALTH NOTIFIED YES NO

HEALTH DEPT CONTACT NAME _____ () _____

IF APPLICABLE:

ARRIVAL AIRLINE _____ FLIGHT # _____ TIME _____

DEPARTURE AIRLINE _____ FLIGHT# _____ TIME _____

**PHOENIX REGIONAL
STANDARD OPERATING PROCEDURES**

PRE-PLANNING FOR EMERGENCIES

M.P. 206.18

10/97-N

Page 1 of 3

PURPOSE

Pre-incident planning can provide valuable information about an occupancy which can improve the ability of firefighters to respond effectively to a fire or other emergency at that location. Pre-incident planning addresses vital fire protection concerns, such as: structure layout including access, contents, construction details, types and locations of built-in fire protection systems. It includes all data which can have an impact on decisions or actions taken during an emergency. Pre-incident planning should be a joint venture between emergency services personnel and the occupants/owners of the property.

This procedure identifies the roles and responsibilities for fire companies, fire districts, Urban Survival for Business, and Dispatch & Deployment in pre-planning for emergencies including: Occupancy selection, Tactical Premise entry into the Phoenix Fire Department RMS system, and record keeping.

FIRE COMPANIES

Each quarter, company officers will select a tactically significant occupancy to pre-plan for emergency incidents in their first due area. What determines a "tactically significant occupancy" may vary according to an individual company's response area but, may include, industrial facilities such as woodworking, hazardous materials, general manufacturing or large storage facilities, residential occupancies such as apartment complexes, condominium complexes, convalescent homes, or senior care facilities, high-rise buildings, health care facilities such as hospitals, clinics or laboratories, and any other occupancy the company officer feels is tactically significant.

When the company officer has selected an appropriate site for a pre-plan, he/she should meet the owner/occupant at the selected site and, together with the owner/occupant, complete the Tactical Premise Pre-plan Authorization Form. Once a pre-plan has been scheduled, the company officer should forward a copy of the Tactical Premise Pre-plan Authorization Form to his/her battalion chief. One copy will be kept by the company officer and placed in the Station Tactical Premise log. A sample of the Tactical Premise Pre-plan Authorization Form can be found in the Tactical Premise handbook.

The company officer is expected to make every pre-plan a training opportunity. Pre-fire planning guidelines can be found in the Building familiarization/Tactical Premise handbook. Pre-plan information should be shared with the other two shifts in the station so they can conduct a walk through in the pre-planned occupancy. **Each company on each shift should schedule and complete a Tactical Premise pre-plan on different occupancies.**

During the pre-plan, the company will fill out the BUILDING FAMILIARIZATION / TACTICAL PREMISE worksheet. Companies are encouraged to make drawings or record other information which may be useful in a response book carried on the apparatus. When the company returns to quarters, the information on the Building Familiarization/Tactical Premise worksheet is entered into the Tactical Premise portion of the RMS system in the station computer. **NOTE: If the company is located in a Fire District with a designated Tactical Premise Coordinator, the completed Building Familiarization/Tactical Premise worksheet is forwarded to the District Office for entry into the CAD system** (see District Responsibilities). Once the information has been entered, the company officer will make a computer printout of the Tactical Premise information and forward the printout to his/her battalion chief.

**PHOENIX REGIONAL
STANDARD OPERATING PROCEDURES**

PRE-PLANNING FOR EMERGENCIES

M.P. 206.18

10/97-N

Page 2 of 3

FIRE DISTRICT RESPONSIBILITY

The District Commander may choose to designate a District Tactical Premise Coordinator whose primary responsibility would be Tactical Premise data entry. This would increase the possibilities of consistent data entry.

When the battalion chief receives a copy of the Tactical Premise pre-plan authorization form, he/she will place the form in the District pre-plan log. Battalion chiefs should make every effort to accompany fire companies when they are conducting a pre-plan.

After the pre-plan information is in the RMS system, the battalion chief will receive a copy of the Tactical Premise computer printout and then place it with the Tactical Premise pre-plan authorization form in the District pre-plan log. The date the pre-plan was completed should be added to the Tactical Premise pre-plan authorization form in the space provided.

When the Tactical Premise pre-plan authorization form is completed, the battalion chief will make two copies of the completed form and forward them to the engine and ladder company that completes the 2-1 first due assignment for the pre-planned occupancy so they can access the information in Tactical Premise.

URBAN SURVIVAL FOR BUSINESS RESPONSIBILITY

The fire prevention specialist assigned to each District will review the District pre-plan log at the beginning of each month. The fire prevention specialist will advise the battalion chief(s) that he/she is available should any company need technical assistance regarding Fire Code issues in the buildings scheduled for pre-planning.

Each fire prevention specialist assigned to Urban Survival for Business participates in the Self-Inspection Program and is responsible for contacting 25 businesses per week. The fire prevention specialist will place information received from these contacts into the Tactical Premise portion of RMS including, Business Name and Address, Responsible Party information, and any other information which may be useful to responding companies.

Fire prevention specialists routinely respond to service requests in all categories of tactically significant occupancies, inspect industrial facilities, and respond to fire company requests for service. Every time a fire prevention specialist makes contact with a business or other occupancy, the fire prevention specialist will obtain responsible party information from that occupancy and place that information into Tactical Premise. The fire prevention specialist will occasionally encounter an occupancy which is tactically significant but which has no information in Tactical Premise. The fire prevention specialist will bring this information to the attention of the District Commander of the Fire District which contains the occupancy.

Whenever a fire prevention specialist encounters a situation that changes the Tactical Premise information for a specific occupancy, the fire prevention specialist will enter the changes into the Tactical Premise portion of the RMS system. The Tactical Premise entry will receive a new revision date and a computer printout of the updated information will be made. The fire prevention specialist will then forward a copy of the updated information to the first due company officer. The fire prevention specialist will send a second copy of the Tactical Premise printout to the battalion chief who will update the District Pre-plan log.

**PHOENIX REGIONAL
STANDARD OPERATING PROCEDURES**

PRE-PLANNING FOR EMERGENCIES

M.P. 206.18

10/97-N

Page 3 of 3

DISPATCH AND DEPLOYMENT RESPONSIBILITY

When it becomes obvious that there is a working fire, hazardous materials incident, or other incident which might require information contained in Tactical Premise, the Dispatch and Deployment Captain will immediately begin monitoring the tactical radio channel.

While units are responding or as soon as practical, the Dispatch and Deployment Captain will retrieve tactical and/or responsible party information from the Tactical Premise database using the **TP, TPI, or TPB** commands .

Having the Tactical Premise information displayed at the alarm Captains terminal will allow him/her to provide critical information to command when needed. For example; Phoenix units are working a structure fire at Troy Biosciences, the first in ladder company has not had time to look at Tactical Premise information for this structure and Command says "go to the roof and ventilate."

The Dispatch and Deployment Captain has been listening to the radio traffic and sees that Troy Biosciences (through the Tactical Premise display on his terminal) has a metal clad roof. The Dispatch and Deployment Captain relays this information to Command who advises the Ladder to take a metal saw blade with them. The roof is quickly ventilated and the progress of the fire is stopped.

Tactical Premise may be accessed using the TP, TPI, TPB, RP, RPI, and RPB commands from any terminal in Dispatch. If the Dispatch and Deployment Captain is busy with another incident, the Supervisor or TRO will provide Tactical Premise information as noted above.

PHOENIX REGIONAL STANDARD OPERATING PROCEDURES	
Policy Name: HEAT STRESS MANAGEMENT	Policy Number: M.P. 206.19
This policy is for internal use only and does not expand an employee’s legal duty or civil liability in any way. This policy should not be construed as creating a duty to act or a higher duty of care, with respect to third party civil claims against employees or the Phoenix Fire Department (PFD). Remedies for violations of this policy, if proven, are limited to administrative disciplinary action against PFD employees.	
Related Policies:	
Other Reference:	
Date Implemented: 05/2022-R	Review Date: 05/2028

PURPOSE

The purpose of this procedure is to establish guidelines and responsibilities for minimizing the effects of heat stress to department members.

POLICY

Effective June 1st to September 30th of each year, or at the discretion of the on-duty Shift Commander, Dispatch and Deployment shall provide an additional ALS Engine Company to any working fire incident. A Rehab Unit will be dispatched on all First Alarm and greater incidents.

PROCEDURE

Strenuous physical activities in high temperatures affect all organ systems of the body. The effect is relative to how hot it is, duration of exposure, type of activity, and a variety of other factors. For example, during long and even short duration strenuous activities at temperatures above 105 degrees Fahrenheit, normal cooling mechanisms can be stressed and overwhelmed. In the interest of reducing the impact of heat related stress on members, the following directives are to be followed whenever the temperature is at or above 105 degrees Fahrenheit:

1. Each member will be responsible to:
 - a. Maintain proper rest/nutrition regimen
 - b. Observe appropriate work/rest cycles
 - c. Hydrate before, during, and after each shift (minimize coffee, tea, and cola products)
 - d. Inform supervisor of any ill effects due to heat
2. In addition to the above, Company Officers are responsible for monitoring and managing:
 - a. Cardiovascular activity (i.e., tennis, racquetball, running, etc.) shall be limited to a maximum of 30 minutes

- b. A minimum of 64 ounces (2 quarts) of fluid should be consumed during the 24-hour shift
 - c. Work/rest cycles, request a relief company and assignment to rehab after crew has consumed two bottles of air
 - d. Company activity and request additional resources as necessary
3. During emergency operations the Incident Commander is responsible for the following:
- a. Consider the establishment of a Rehab Sector/Division/Group on all working fires
 - b. Assign companies to Rehab Sector/Division/Group as needed or requested (companies shall remain in rehab for a minimum of 20 minutes)
 - c. Utilize the practice of first company in, first company out routine
 - d. Request additional resources as necessary

**PHOENIX REGIONAL
STANDARD OPERATING PROCEDURES**

COMMUNITY ASSISTANCE PROGRAM (CR UNITS)

M.P. 206.20

1/13-R

Page 1 of 2

CR units have three primary goals: 1) Meet the needs of our customers involved in traumatic situations; 2) Follow-up on frequent flyer referrals and provide customized customer oriented solutions; 3) Provide counseling services as needed to our members as a part of our firefighter wellness program.

The services consist of on-scene crisis intervention, occupant services, and short term crisis counseling. The CR team(s) will also provide victim service information and social service referrals. The CR units have phone numbers for counseling, hot lines, crisis services, and other available community resources (including food boxes, utility assistance, and elderly assistance.)

Some of the services provided are:

- Grief support
- Crisis intervention (domestic violence, sexual assault victims)
- Emotional support
- Internal customer assistance
- Transportation
 - CR teams carry child car seats (3 per van)
 - CR teams have access to a wheelchair van
- Care Bears, squencher, water, blankets, and coloring books.

The response hours are listed in CAD as CR1, CR12, CR16, and CR25. The CR1 supervisors are available on-call 24/7 and can assist whenever CR1 unit is not in service. 602-370-5721

RESTRICTIONS:

Non-medical Transport

- CR vans will transport non-injured family or friend to the hospital to be with the injured person.

Transport

- No ETOH, where the subject is not alert and oriented x 4 **or** not in control of bodily functions **or** is combative **or** suicidal. CR teams will go on-scene and will wait with the customer until C.C., Comtrans, P.D., a CRN response unit, family or other support system to arrive.

Mentally Ill

- CR vans will not transport a seriously mentally ill customer who is actively delusional or suicidal. CR teams will go on-scene and will wait with the customer until Comtrans, P.D., a CRN response unit, family member or other support system to arrive.

PHOENIX REGIONAL
STANDARD OPERATING PROCEDURES

COMMUNITY ASSISTANCE PROGRAM (CR UNITS)

M.P. 206.20

1/13-R

Page 2 of 2

DISPATCH WITHIN CITY of PHOENIX

- CR teams are automatically dispatched on:
 - Codes (adult and infant)
 - Drowning (adult and child)
 - 2nd alarm fires
 - Major assaults
 - Hangings

- CR teams also respond to:
 - Domestic violence
 - Simple assaults
 - Sexual Assaults
 - Death notification
 - Working House Fires
 - Occupant Services
 - Suicides
 - Mentally Ill
 - Homeless
 - Child and Elder abuse
 - Lost children or elderly person

DISPATCH OUTSIDE THE CITY of PHOENIX

Phoenix CR teams will respond outside of the City of Phoenix when there is a special request from another City's police or fire personnel. (Examples: Member services issue or severe injury)

Phoenix CR teams will not respond outside the City of Phoenix on routine calls such as codes, fires, homeless, or mentally ill, without prior approval from a CR Supervisor.

PHOENIX REGIONAL STANDARD OPERATING PROCEDURES	
Policy Name: LIGHT RAIL OPERATIONS	Policy Number: M.P. 206.21
This policy is for internal use only and does not expand an employee's legal duty or civil liability in any way. This policy should not be construed as creating a duty to act or a higher duty of care, with respect to third party civil claims against employees or the Phoenix Fire Department (PFD). Remedies for violations of this policy, if proven, are limited to administrative disciplinary action against PFD employees.	
Related Policies:	
Other Reference:	
Date Implemented: 12/2021-R	Review Date: 12/2026

PURPOSE

This procedure provides guidelines for managing emergency incidents involving the Valley Metro Light Rail System (VMR), highlights specific life safety hazards inherent to the system, and also discusses considerations for shutting down power to the system when necessary. This procedure also provides light rail system information necessary for safe operation and focuses on the most likely light rail scenarios crews will encounter. However, these guidelines are not a universal remedy, and due to the limitless possible scenarios responding personnel could encounter, responding crews should always evaluate risk and exercise caution when operating near the light rail system.

LIGHT RAIL TERMS

LRV= light rail vehicle

OCS= overhead catenary system (overhead light rail electrical wires)

TPSS= traction powered substation

ETS= emergency trip switch (located at TPSS)

OCC= operations control center (nerve center for communications and operations of light rail)

Pantograph= large mechanical arm that connects the LRV to the overhead wires

BACKGROUND

The Light Rail Vehicles (LRVs) operate on DC electric current supplied from the substations (TPSS) by two overhead wires (OCS). LRV's connect with the light rail system in an electrically powered public transportation system. The light rail uses a two-track system that typically run parallel to each other. The LRVs connect with the OCS via a pantograph (large mechanical arm) that can be raised and lowered. The tracks operate as the negative return (not a significant electrical threat) for the current. The Operations Control Center (OCC) functions as the nerve center for the light rail and is able to communicate directly with light rail Operators, Transportation Supervisors, and maintenance crews. The OCC is responsible for coordinating all light rail related emergency

activity. In the event of an emergency, the OCC has the ability remotely de-energize the OCS. The OCC is located in the VMR Operations and Maintenance Center (605 SS. 48th St, Phoenix). The estimated train frequency is every 12 minutes during peak operations and every 20 minutes during off-peak hours. The LRV's are controlled with an Operator located in the forward cab (each end has a cab) of the LRV. The Operator must operate the train by utilizing a controller which controls accelerations and braking. The controller is equipped with a "dead man" switch, which will bring the LRV to a complete stop if the Operator becomes incapacitated. The system times traffic lights using a predicative priority signally system that changes the signals much like the pedestrian button and car sensors do, but the only system that actively takes control of traffic signals is the Opticom system (when equipped) used by emergency responders. Train operators are required to stop for all red lights and hazards.

LRV

- 90 feet long, 12 feet high, 9 feet wide Cab at each end (1 Light Rail Vehicle)
- 103,000 lbs. empty with 200-person max capacity
- Normal max operating speed 35 mph
- Approximately 190 foot stopping distance at 35 mph
- Very Quiet

TRACK SWITCH LOCATIONS

- Allow train movement from one track to another
- Track switches move without warning
- Controlled manually / remotely
- Exert 1200 lbs. of force
- Will crush obstacles, including hands/feet if in switch location
- Manually operable

TRACTION POWER SUBSTATIONS (TPSS)

- Located approximately every mile
- Emergency Trip Switch (ETS) (located outside the door in Knox box)
- What's inside: electrical equipment and Ni-cad batteries
- Electricity AC 12000-21000 volts in, and 650-950 volts DC out

OVERHEAD CONTACT SYSTEM - OCS (THE OVERHEAD WIRES)

- 750-950 Volts Direct Current (DC)
- 2000-6000 AMPs (Taser is .00021 amps 50k volts)
- Wires are tensioned at 5,000 lbs. top wire, and 3000 lbs. bottom wire
- Wires will whip if severed
- The normal height of the light rail overhead contact system wire is 18 feet; however, the underpass at Washington and the SR143 has a max height of only 14.5 feet. BEWARE of lights, flags, or anything else sticking up when crossing the line

RESPONSE

Crews responding Code 3 across the tracks shall adhere to our Code 3 driving procedures. Additionally, any protrusion (extended utility lights, flags, etc.) must be lowered to avoid contact with OCS. Furthermore, the tracks represent an additional lane of traffic that must be cleared when driving. Left hand turns across the tracks account for the highest incidents of collisions with LRV's.

- Adds additional lane of traffic
- Normal height of OCS is 18 feet
- Lowest point is 14.5 feet located at Washington and the SR143 overpass
- Have all lights and/or flags lowered

OPERATING IN LIGHT RAIL INTERSECTIONS

LRV's are approximately 9 feet wide and operate on fixed rail. As such, LRV's are incapable of making contact with an object located outside of the LRV's dynamic envelope. LRV Operators are trained to operate at walking speed when emergency personnel are near the tracks. LRV's are equipped with a Car Wash Mode feature which restricts speed to no greater than 2MPH. The car wash mode may be activated upon request. If LRV movement could compromise the safety of firefighters operating on or adjacent to the light rail tracks, the Company Officer should contact Fire Dispatch and request a notification be made to the OCC to operate LRV's on the alternate track (Single Track Operation). The OCC will dispatch a Transportation Supervisor to the scene and implement an alternate service plan to ensure the safety of Fire personnel. Crews must remain watchful for LRV's, and Company Officers should consider assigning a crew member to watch for LRV's. In scenarios where both light rail tracks are obstructed (e.g., collision blocking both tracks, supply lines etc.) Company Officers must contact the Fire Dispatch and request a notification be made to the OCC advising of such conditions.

RESPONDING TO EMS CALLS ON THE LRV

- LRV Operator will coordinate next stop location with OCC and Alarm Room.
- The alarm room will provide the address and location during dispatch.
- Any open door on an LRV engages the brake and disables the throttle ensuring that the LRV will not move.
- As long as the LRV is functioning normally and on the track, there is no need to shut down power. This will allow the AC and lights to continue functioning.
- Maintain awareness of both LRV and vehicle traffic.

RESPONDING TO LRV VERSUS ANOTHER VEHICLE

When an LRV makes contact with a vehicle, the LRV Operator will notify the OCC. The Operator will then check all LRV's, and the occupants of the other vehicle for injury. All injury information will be relayed to the OCC. Due to low operating speeds most LRV collisions will not result in a derailment. A collision with a large vehicle (e.g., semi-truck, dump truck etc.) may result in a

derailment. If this occurs the LRV Operator will lower the pantograph and eliminate the electrocution risk from the OCS.

In the event of derailment where the pantograph becomes entangled or is unable to be lowered, the entire LRV becomes energized and poses a significant electrocution risk to both emergency responders and any passenger who makes ground contact (completes the circuit).

Company Officers should complete the following evaluation upon arrival to any LRV derailment or LRV vs. large vehicle accident:

ELECTRICAL HAZARD SIZE UP QUESTIONS

- Is the LRV on the tracks?
 - If LRV is on tracks, pantograph may stay raised.
 - If LRV is derailed, pantograph must be lowered.
- Is the Pantograph raised/tangled?
- Is the OCS intact (no poles or wires down)?

ELECTRICAL HAZARD SIZE UP

Scenario #1: If the LRV is derailed and the pantograph is still in contact with the OCS, responding crews should not make contact with the LRV and advise the LRV Operator to lower the pantograph. If the LRV Operator is unable to lower the pantograph, the Company Officer must de-energize the OCS by employing the use of Option #1 or Option #2.

Scenario #2: If the OCS has been compromised or appears to be severely damaged, or if lines are down then crews should not approach the LRV or track. The OCS must be de-energized by employing the use of Option #1 or Option #2.

Option #1: The Company Officer must contact Fire Dispatch and request a notification be made to the OCC to remotely de-energize the OCS. The OCC will have a visual notification that the OCS has been de-energized and will dispatch a Transportation Supervisor to respond to the incident scene with a Hot Stick to provide physical assurance that the OCS is de-energized.

Option #2: The Company Officer should assign another company (or do it themselves if in close proximity) to push the emergency trip switch (ETS) at the closest TPSS (requires Knox key). Pushing the ETS at the TPSS shuts down incoming AC power and outgoing DC power, and also sends a signal to the adjacent substations and shuts down their outgoing DC power, effectively isolating the section of line from power. However, there is no visible confirmation that power has actually been shut down. The Company Officer must contact Fire Dispatch and request a notification be made to the OCC requesting a Transportation Supervisor with Hot Stick to confirm that the OCS is de-energized.

In both instances Crews should refrain from physically touching the LRV and advise passengers to wait inside the LRV, until power has been confirmed to be de-energized.

ACCESS AND EXTRICATION

- Easiest access is through the LRV doors. Crew can manually open them by opening the exterior (emergency door releases). There is one location on each side of the vehicle, located on the left side when facing the LRV.
 - Windows are extremely hard to break
 - Cutting through the body of the LRV doesn't provide adequate access
- The train has been engineered with a bumper and bar 3 inches off the track to reduce the chance of a person becoming trapped underneath.
- LRV's are extremely heavy and unstable when lifting and this should be considered a last resort.
- Valley Metro has a vehicle that can safely lift LRVs, but it has an estimated response time of 30-60 minutes

TRAFFIC CONTROL

- Protect scene as necessary
- Beware of other LRV's in opposite direction
- Consider assigning a crewmember as lookout for LRV's
- Consider PD for traffic control

RESPONDING TO LRV FIRES

LRVs do not have a fire protection system (no sprinklers). Most of the working equipment (A/C, power supplies, and batteries) are located on the top of the LRV. Crews must ensure the LRV, and OCS are de-energized prior to attempting extinguishment of any significant LRV fires. Fires in the bottom undercarriage should only be extinguished after the pantograph has been lowered but does not necessitate shutting down the OCS.

Evacuate LRV (life safety first) to a safe location away from smoke

- Shut down power as necessary
- Stop other LRV traffic as necessary
- Protect the scene from traffic

RESPONDING TO FIRE AT TPSS

- Treat it like electrical substation/vault
- Do Not Enter or put water on it until absolutely confirmed de-energized by APS or SRP
- Beware of OCS
- Consider pushing the ETS, if it is safe to do so
- Call for hazmat if smoke is coming from within TPSS
- Be aware of the risk of hazardous smoke inhalation

MISCELLANEOUS

Natural Gas Incidents

- LRV's produce significant sparks and represent an ignition source for natural gas leaks
- LRV's traffic should be halted for any significant gas leak within close proximity

Impact of Smoke Plume on Light Rail System

- Treat the same way we treat other road closures for smoke plumes
 - LRV's have the ability to shut off outside air if necessary, and this should be a minimum consideration if LRV's are passing by smoke

IMPACTS TO FIRE OPERATIONS

The light rail system impacts Fire Department operations in several ways. First, the OCS represents an electrical hazard as do other electrical lines. OSHA requires any apparatus, ladders, or other equipment to maintain a ten-foot clearance from ungrounded electrical sources such as the OCS. The tracks present access obstacles and influence apparatus placement. Lastly, the alignment can impact water supply.

Consider the following:

- OCS electrical hazards
 - Must stay 10 feet away (in every direction) per OSHA
 - Electrocutation risk if straight stream contacts energized OCS
 - Ensure that operating hose streams do not contact the OCS
- Fire ground apparatus placement
 - Crews should preplan first due areas and plan apparatus placement around the light rail
- Laying supply lines across tracks
 - Treat as a water supply of last resort and avoid whenever possible
 - If it is necessary to lay supply lines across the tracks, the Incident Commander will need to communicate clearly to the Alarm Room that they are doing so, and advise them to shut down light rail traffic for that section

**PHOENIX REGIONAL
STANDARD OPERATING PROCEDURES**

**HAZARDOUS MATERIALS WEAPONS OF MASS DESTRUCTION
CHEMICAL, BIOLOGICAL, RADIOLOGICAL-- RESPONSE OPERATIONS**

M.P. 207.01A

07/03-N

Page 1 of 14

Response actions at a Weapons of Mass Destruction (WMD) incident can be divided into those undertaken by operational responders and those undertaken or supervised by hazmat technicians. Medical management includes decontamination, triage, treatment, behavioral health and transportation. The specific WMD agent involved -- chemical, biological or radiological -- has an impact on scene management. All WMD terrorism incidents are crime scenes; police sector needs early establishment. Additional detail for WMD response operations may be found in *Phoenix Fire Department WMD Field Operations Guide (FOG)*.

FIRST ARRIVING UNITS

The first arriving officer will establish Command and begin a size-up. Survey visible activity, signs and symptoms. Notice potential effects of wind, topography and location of the incident. Route other responding companies away from visible hazards.

Command will establish level II staging whenever possible. Care must be taken to establish staging in a safe area, taking into account the characteristics of the likely WMD agent (chemical, biological, radiological).

Area Isolation/ Perimeter Establishment

I. Command Size-up gathers information for incident management plan

- In known or suspected explosions when purposeful or terrorist activity cannot be ruled out (i.e., natural gas explosion) initial actions should be to secure a hot zone perimeter and call for the EOD (PD bomb squad) to respond.
- Entry into the hot zone/crime scene should be under the direction of unified Command with Haz Mat – radiological monitoring, Tech Rescue – secondary collapse, and EOD secondary explosive devices/crime scene, issues being addressed.
- If victims are present the Incident Commander should establish communication quickly to control their anxiety and behavior. Select a fire member/officer (preferably paramedic) as a point of communication to establish rapport and credibility. If possible all direct communications to victims should be conducted/coordinated through this person.
- A WMD/terrorist incident is a CRIME SCENE. Once fire/hazmat work is complete, scene passes to FBI.
- Remember any signs of WMD devices, dispersion apparatus, or other potential evidence.
- BE AWARE OF SECONDARY DEVICES designed to injure additional victims and/or first responders. Upon sighting a device that appears operable, withdraw personnel until Police Bomb Squad has inspected/rendered safe any suspicious appearing device.
- Remember locations of potential evidence; do not move or collect it yourself.
- Pay attention to symptoms exhibited by victims for relay to hazmat/paramedic personnel.
- Prepare to Evacuate nearby area if indicated by wind, explosive or similar danger.

**PHOENIX REGIONAL
STANDARD OPERATING PROCEDURES**

**HAZARDOUS MATERIALS WEAPONS OF MASS DESTRUCTION
CHEMICAL, BIOLOGICAL, RADIOLOGICAL-- RESPONSE OPERATIONS**

M.P. 207.01A

07/03-N

Page 2 of 14

- If fire is present and radiological agent suspected, evacuate to 2000 feet. Check downwind areas for contamination.
- IN THE CASE OF LETTER OR PACKAGE CONTAINING UNKNOWN SUBSTANCE:
 - Quarantine persons in the immediate area of exposure (office or room) and place them in a safe refuge area.
 - Isolate the area that the substance or package is located; hold for Hazmat Team to double bag and secure.
 - Control Heating and Air Conditioning (HVAC) Systems by shutting down to prevent spread of contamination.

DO NOT USE SPECIFIC NAME OF SUSPECTED AGENT OVER THE RADIO; USE ONLY ABIOLOGICAL AGENT@ OR AUNKNOWN AGENT@.

If a biological agent is contained in a single room or office in a multi-function building, the building should be evacuated.

II. IF NO APPARENT VICTIMS, LIFE HAZARD, RESCUE SITUATION, OR FIRE EXIST, FIRE DEPARTMENT PERSONNEL SHOULD NOT BE EXPOSED TO RISK.

First arriving units should secure a perimeter, evaluate the situation, and await the arrival of the Hazardous Materials Technicians.

- USE AVAILABLE PPE TO MINIMIZE SAFETY RISKS FOR OPERATIONAL RESPONDERS.

Minimize entry of first responders into HOT ZONE.

Minimum PPE is turnouts, butyl rubber gloves and SCBA.

III. Establish Zones of Limited Access.

- The **HOT ZONE** is the area immediately around the site/munition/device/source. Enforce a single entry control point. All personnel entering this area must wear full protective gear. The entry control point should be a minimum of 300 feet from the source. This applies whether suspected agent is chemical, biological or radiological.
- The **WARM ZONE** is upwind and uphill from the Hot Zone for Chemical and Radiological Threats. Biological agents are non-volatile and controllable: if contained in a building little downwind threat is posed; if release point is in the open, downwind hazard may exist.

**PHOENIX REGIONAL
STANDARD OPERATING PROCEDURES**

**HAZARDOUS MATERIALS WEAPONS OF MASS DESTRUCTION
CHEMICAL, BIOLOGICAL, RADIOLOGICAL-- RESPONSE OPERATIONS**

M.P. 207.01A

07/03-N

Page 3 of 14

Hot Zone Support, Rescue, and Technical Decon personnel operate in WARM ZONE with full protective gear. Decon lines are established in the WARM ZONE. This area should be minimally 15 feet wide, but must encompass all victims awaiting decon and decon equipment. A LOBBY SECTOR will be established at the entry to the warm zone for accountability.

- The **COLD ZONE** is outside the Warm Zone. For Chemical and Radiological agents, COLD ZONE is uphill and upwind from Warm Zone. No contaminated personnel or equipment should pass into the COLD ZONE. Incident Command, medical and transportation are located in the COLD ZONE. Personnel should keep protective gear at hand in case of wind shift or accidental contamination.

IV. COORDINATE WITH POLICE TO ESTABLISH SECURITY FOR SITE

- Police will secure scene to insure safety for victims and emergency responders.
- Police will search immediate area for presence of secondary devices.
- If potentially explosive devices are sighted or suspected, Police Special Assignments Unit will investigate and clear. Fire personnel will withdraw to safe staging area until safe re-entry is possible. Fire personnel will NOT move or disarm suspected devices.
- Victims and others will be denied entry and exit from HOT ZONE. Police will enforce these restrictions. Fire personnel will NOT use physical force to restrain public.

Equipment Positioning

Position equipment upwind, uphill and upstream from the incident site. If the incident is indoors, insure any ventilation exhaust ports are not blowing vapors into the established response areas. Shut down HVAC systems to minimize contamination spread.

Assess Downwind Hazards

Be aware of the presence of, or potential for downwind, plumes. This threat exists for chemical, biological and radiological [particles] agents. If a downwind hazard exists, initiate appropriate action (evacuation or shelter-in-place) for those at risk. Adjust incident perimeters to account for windage risks.

Gather Casualties/Initiate Victim Management

- I. Immediately begin process of gathering ambulatory victims.
 - Using an amplified PA system, direct victims to an established holding area to await evaluation and emergency gross decontamination.
 - If deaths occur during sorting, redefine HOT ZONE perimeter to include bodies.
 - Explain emergency decontamination to victims.

**PHOENIX REGIONAL
STANDARD OPERATING PROCEDURES**

**HAZARDOUS MATERIALS WEAPONS OF MASS DESTRUCTION
CHEMICAL, BIOLOGICAL, RADIOLOGICAL-- RESPONSE OPERATIONS**

M.P. 207.01A

07/03-N

Page 4 of 14

- Once emergency decon is complete, sort ambulatory victims into:
 - People with Special Needs
 - Gender groups
- Continue to process any additional victims who exit the impact area.

II. USE CAUTION [PPE] WHEN CONTACTING VICTIMS

- Those exposed to CHEMICAL agents may be off-gassing.
- BIOLOGICAL victims may be contaminated with particles or droplets of agent.
- RADIOLOGICAL victims pose no danger; particles on skin or clothing brush or wash off.

III. NOTE LOCATIONS OF DEAD AT SCENE

- HOT ZONE perimeter should be defined to include all dead bodies.
- Unless absolutely necessary do not move bodies.

IV. NON-AMBULATORY VICTIMS SHOULD LIE IN PLACE

- If necessary administer emergency medical measures WHILE WEARING PPE.
- If external threat (building collapse, etc.) threatens, move victim(s) to safe area.

V. NOTE VICTIMS IN NEED OF RESCUE. Do not undertake rescue without PPE

VI. DEAD ANIMALS AND BIRDS AT THE SCENE

Deceased animals and birds at the scene will be handled as deceased people are handled, expanding the Hot Zone to include their locations. Once scene operations have concluded, Maricopa County Animal Control (MCAC) will be notified of the presence of deceased and contaminated animals.

Emergency Decontamination

- I. Emergency decontamination for chemical agents should begin as soon as possible.
- Emergency Decon serves three functions:
 - Marks victims for easy identification
 - Removes product/particles from victims
 - Engages victims in activity that reduces anxiety.

**PHOENIX REGIONAL
STANDARD OPERATING PROCEDURES**

**HAZARDOUS MATERIALS WEAPONS OF MASS DESTRUCTION
CHEMICAL, BIOLOGICAL, RADIOLOGICAL-- RESPONSE OPERATIONS**

M.P. 207.01A

07/03-N

Page 5 of 14

- Using PA system/bull horn, instruct victims on procedure:
 - spread arms and legs wide; turn slowly so all parts of body are rinsed; clothing is NOT removed for emergency decon unless patient was exposed to a liquid splash.
 - Victims will be thoroughly wet using a booster line. Soak victims from top of head downward with copious amounts of water.
- In an event with multiple victims, which may inundate the booster line procedure of emergency decontamination, a master stream(s) creating a dense shower flow should be established as a more effective method of mass casualty emergency decontamination.

II. Minimum PPE for decontaminating victims is turnouts and SCBA.

III. Locate Emergency Decon corridor Upgrade from HOT ZONE if possible. Notice direction and impact of uncontrolled runoff for referral to clean-up.

Note: Emergency decontamination is not necessary for biological and radiological contamination. ONLY victims who have other medical injuries that require immediate medical attention should be prioritized and decontaminated as necessary.

HAZMAT UNITS

Hazmat Sector Establishment, Site Assessment

I. Command -- through Hazmat -- will make site assessment to:

- assign levels of PPE;
- confirm/adjust hot/warm/cold zones and incident perimeter; For Radiological Agent, HOT ZONE is defined as area where survey instruments produce readings of 2 MR/hour and higher;
- confirm/adjust equipment placement.
- reassess downwind hazards; implement evacuation/shelter-in-place as needed.

II. Operations personnel become support.

III. Hazmat brings necessary pharmaceuticals/antidotes to the scene.

Hazmat Initiates Technical Decon Set-up/Operation

I. WMD Technical Decon Lines for personnel and equipment described in MP 204.14C?

II. If available and time permits, Female Decon Team Assists with set-up then operates female/special needs line.

**PHOENIX REGIONAL
STANDARD OPERATING PROCEDURES**

**HAZARDOUS MATERIALS WEAPONS OF MASS DESTRUCTION
CHEMICAL, BIOLOGICAL, RADIOLOGICAL-- RESPONSE OPERATIONS**

M.P. 207.01A

07/03-N

Page 6 of 14

III. Three shelters will be assembled: Two Ambulatory and a Special Needs/Non Ambulatory decontamination shelter for victims requiring assistance, staffed by a male and female support group.

- Each decontamination shelter will be staffed with a minimum of 5 personnel (for mass casualty incidents) processing victims through the various stations.
- A Separate Technician Decon operation should be set up for response personnel away from the victim decon lines.
- Non-ambulatory and Special Needs Victims will be processed through decon lines with assistance rendered as necessary by station attendants.
- Decon of Deceased takes place AFTER ambulatory and non-ambulatory victims are deconned, treated and transported.
- If Federal response is not available, deceased victims may be decontaminated by Fire Department personnel trained in stripping and decontamination of bodies before the **Maricopa County Medical Examiner's Office** assumes control of the body. Victims who expire after decontamination (in the cold zone) will be held for the County Medical Examiner's Office.

Hazmat: Initial Entry

I. Initial entry into the Hot Zone will be made by Hazmat Technicians.

- For Chemical agents level A protection is worn. All personnel entering the Hot Zone will carry THREE Nerve Agent Antidote Kits (MARK I) for self administration as needed.
- For Biological agents, the level of protection is worn, as assigned by IC consulting with HazMat and toxicologists/poison control.
- For Radiological threats, minimum PPE is turnouts, butyl rubber gloves and SCBA; XETEX dosimeters will be worn by all entering Hot Zone.

II. Two entry teams and appropriate backup teams will be established. One entry team will be assigned to victim rescue and extrication. The second entry team will address agent identification.

III. When victims are trapped, extrication, high angle rescue, trench rescue, or other technical rescue may be used.

- Extrication is conducted by the Extrication Sector of the Medical Branch, assisted by other PFD special units. If special equipment or skills are demanded to achieve rescue, PFD Technical Rescue Teams (TRT) will be used.
- Non-ambulatory, but not trapped, victims located in the Hot or Warm Zones will be handled only by personnel in appropriate PPE. Hot zone rescues only by Hazmat.

**PHOENIX REGIONAL
STANDARD OPERATING PROCEDURES**

**HAZARDOUS MATERIALS WEAPONS OF MASS DESTRUCTION
CHEMICAL, BIOLOGICAL, RADIOLOGICAL-- RESPONSE OPERATIONS**

M.P. 207.01A

07/03-N

Page 7 of 14

Hazmat: Agent Identification

- I. All **Chemical incidents** will be treated as a Hazmat situation. The standard chemical detection and air monitoring devices (i.e., HAZCAT) will be used during a response. If the incident is suspected or confirmed to involve unconventional warfare chemicals, the following list of detection devices (in conjunction with the standard equipment) will be used for agent identification:

M-8 Chemical Detection Paper - chemical liquids
M-9 Chemical Detection Paper - chemical liquids
Dragger Colorimetric Tubes - chemical vapors
M256 Chemical Detection Kit - chemical liquids and vapors
APD-2000 CW Detector - chemical vapors

In all cases where a chemical WMD is suspected, every available chemical detection device will be used for secondary and tertiary confirmation of suspected chemicals.

- II. For **Biological incidents** sampling is necessary and scene assessments will be undertaken if equipment is available.
- Hazmat teams will collect and test samples of any suspected Biological agent with the appropriate field detection kit. Phoenix PD will transfer the sample to the Arizona Department of Health Services (ADHS) State Laboratory for further testing and identification.
 - Toxicology support is available at the scene and/or in the EOC through the Samaritan Regional Poison Control Center.
 - Phoenix Police Department personnel will transport suspected biological agent samples to the ADHS State Laboratory.
- III. For **Radiological incidents**, Victoreen Instrument CDU-700 and Ludlum Model IIC Radiacmeters will be used to identify the source of contamination and designate zones of operation (Hot, Warm and Cold). The same instruments will be used to monitor personnel. The Arizona Radiation Regulatory Agency (ARRA) will be notified to deploy teams to assist with defining the extent of contamination.

Hazmat: Safety and Secondary Devices

- I. Beginning with first at scene, all personnel will be cognizant of bombs and secondary devices in their areas of operation. **No PFD personnel should ever inspect or move a suspected secondary device.**

**PHOENIX REGIONAL
STANDARD OPERATING PROCEDURES**

**HAZARDOUS MATERIALS WEAPONS OF MASS DESTRUCTION
CHEMICAL, BIOLOGICAL, RADIOLOGICAL-- RESPONSE OPERATIONS**

M.P. 207.01A

07/03-N

Page 8 of 14

- II. If operational personnel locate a suspected secondary device, the Hot Zone will be expanded to include the device. All Fire personnel will withdraw from the area. Police Bomb Technicians will enter the area to render the device safe. Once safety has been established, PFD will resume operations.
- III. If a secondary device is discovered by Hazmat technicians as they make entry into the Hot Zone, they will withdraw from the area. PD bomb technicians will enter the area with PPE to render the device safe. Fire operations will resume after safety has been established.
- IV. The Phoenix PD bomb technicians will operate with two teams. The first team is an Entry (Render Safe) Team. The second team is *back-up* to the Entry Team. If the threat is large enough to demand the use of two PD entry teams, PFD Hazmat personnel, if available, will provide a back-up rescue team to support PD operations in the Hot Zone.

MEDICAL MANAGEMENT

- I. Whether the agent is chemical, biological or radiological, victims of a Weapons of Mass Destruction/terrorist incident may present injuries caused by explosions, fire, falls, or other mechanisms not directly related to the hazard agent itself. These can include cardiac symptoms. As appropriate, treatment of such injuries should be initiated in the field.
- II. For victims in a **chemical incident**, treatment protocols will follow established agent specific guidelines. For nerve agents (sarin, soman, VX) Mark I Kits are used for adults; atropine injections for pediatric. Oxygen is administered for choking agents. Amyl Nitrate (or sodium nitrite or sodium thiosulfate) is given for Blood agents. Blister agents are given supportive therapy for blisters plus pain medication.
- III. For **biological agent** victims, it is possible that no symptoms may be present. If an agent is positively identified, patients will be decontaminated and moved to hospitals or other shelters for quarantine or observation.
- IV. Victims of a **radiological agent** are unlikely to exhibit specific symptoms at the scene. Exposure to ionizing radiation produces tissue and cell changes that are slow onset. Radioactive particles are easily removed from skin and clothing. **RADIATION EXPOSURE ALONE IS NOT A MEDICAL EMERGENCY.**
- V. Treatment and triage are responsibilities of the IMS Medical Sector/Branch with information from Hazmat. Extrication from the Hot Zone and decontamination is part of the Hazmat Sector/Branch. In a small incident, Transportation may be a sector under the Medical Branch; with a large number of victims.
- VI. Command will assess scene stability and determine whether medical sector/branch is located at the scene or away from the scene.

**PHOENIX REGIONAL
STANDARD OPERATING PROCEDURES**

**HAZARDOUS MATERIALS WEAPONS OF MASS DESTRUCTION
CHEMICAL, BIOLOGICAL, RADIOLOGICAL-- RESPONSE OPERATIONS**

M.P. 207.01A

07/03-N

Page 9 of 14

Triage

- I. The objective of triage is to sort victims so that the maximum number of lives may be preserved through rapid and effective use of medical therapeutics.
 - S.T.A.R.T. (Simple Triage And Rapid Treatment) criteria will be used for triage, using four classifications:

IMMEDIATE: requiring immediate treatment for survival;
DELAYED: not likely to be adversely affected by delay in treatment or movement to definitive care;
MINOR: ambulatory and able to follow simple commands, may or may not require minor treatment;
DEAD OR DYING.

- II. The Arizona S.T.A.R.T. triage tag will be used for all patients. The tag shows patient classification and also identifies injuries and treatments administered in the field, and becomes the tracking base for patients.
 - In the event of a very large number of victims, triage may be indicated initially by marking the priority on the patient's forehead with the felt pen. In such cases, the triage tag will be attached as soon as feasible.
 - Triage tag numbers are used for patient tracking; the triage tag becomes part of the patient record after arrival at hospital. Triage tags remain attached to patients transferred from the scene to the National Disaster Medical System (NDMS) for forward movement.

Treatment

- I. Treatment areas will be established in the cold zone.

- II. Medical treatment will address supportive needs of patients. Care for injuries (sustained in explosions, fires, falls or other events related to the incident) collateral to WMD agent exposure will be administered. Particular attention is reserved for airway/respiratory and cardiovascular support. For all agents, patients will have experienced a terrorist event demands attention be given to Behavioral Health issues.

Treatments administered at the scene will be guided by agent identification and medical advise from toxicology/poison control personnel.

- For **chemical exposures**, if agent is identified antidotes may be initially administered during decon and continued in treatment area. Antidote choice and dose are agent specific.

**PHOENIX REGIONAL
STANDARD OPERATING PROCEDURES**

**HAZARDOUS MATERIALS WEAPONS OF MASS DESTRUCTION
CHEMICAL, BIOLOGICAL, RADIOLOGICAL-- RESPONSE OPERATIONS**

M.P. 207.01A

07/03-N

Page 10 of 14

- For **biological agents**, antibiotic or antitoxin administration may initiated after decontamination as directed by toxicology/poison control.
 - For **radiation exposures**, symptomatic support is offered [no antidotes or efficacious treatments exist].
- III. For otherwise uninjured patients exposed to **biological agents**, if victim is non-symptomatic, treatment may be confined to observation or initiation of antibiotics/antitoxins. Command will determine if patients that are to be observed are transported to hospitals or to shelters. Patients receiving initial antibiotic doses may be directed (by Command) to obtain further antibiotics from public health authorities, from hospitals, or from private physicians. Treatment Sector Officer may refer patients to Behavioral Health personnel and/or Police Sector for interview.
- IV. For otherwise uninjured, not contaminated and non-symptomatic patients exposed to **radiological agents**, Treatment Sector Officer will review and
- a. direct to treatment by a private physician;
 - b. refer to Police Sector for interview; and/or
 - c. refer to Behavioral Health personnel for interview.
- V. For victims of **chemical agents**, exposed patients whether currently symptomatic or not-require observation. Symptomatic patients require antidotes and supportive therapy. Non-symptomatic patients, particularly those exposed to nerve or blister agents, may become symptomatic within hours. Patients who can be confirmed as not exposed may be referred by Treatment Sector Officer to Behavioral Health personnel and/or Police Sector for interview.
- VI. PHARMACEUTICALS will be brought to the incident scene with the responding Hazmat teams or tox medic units. Additional Pharmaceuticals and equipment will be transported to scene as needed.
- VII. Specific treatment protocols for WMD agents are described in M.P. 201.14D.

Behavioral Health

- I. Behavioral Health needs of victims will be addressed by Community Assistance Program (Alternate Response) units (with call-up from TERROS, EMPACT and American Red Cross as needed).
- The mission of these personnel is to attend to the crisis mental health needs of victims and responders, thereby assuring smooth operation and continuous flow of patients through decontamination, treatment and transportation.

**PHOENIX REGIONAL
STANDARD OPERATING PROCEDURES**

**HAZARDOUS MATERIALS WEAPONS OF MASS DESTRUCTION
CHEMICAL, BIOLOGICAL, RADIOLOGICAL-- RESPONSE OPERATIONS**

M.P. 207.01A

07/03-N

Page 11 of 14

- II. On scene, Behavioral Health Units may be assigned (in appropriate PPE) to decontamination lines, in the treatment areas, and at the Transportation Sector to perform their behavioral health functions.
- III. Behavioral Health Units and personnel will be deployed to receiving hospitals to support hospital behavioral health professionals in caring for short-term victim needs, including debriefings. If mass shelters are established for victims, Behavioral Health personnel will provide similar services at those locations. During the incident, Behavioral Health personnel will be available to address short-term crisis needs of victim family members.

Transportation

- I. The Transportation Sector/Branch moves patients from the scene to receiving hospitals or to shelters as assigned by Command.
 - Only patients who have been decontaminated will be transported.
 - Zones will be designated in or near treatment areas to serve as collection points for patients to be transported.
- II. Ambulatory victims, once given initial assessment, decontamination and treatment, can be transported en mass on designated vehicles (busses and other multiple patient transports). Patients whose condition merits will be transported to medical facilities via ambulance. If appropriate and such transport will not further disperse the agent, air transportation may be used.
- III. Decontaminated, uninjured patients may be released or transferred to mass shelter locations as determined to be appropriate by Command. Names and contact information will be recorded for all released individuals for any necessary post-incident follow-up as well as behavioral health interviews.
- IV. Some civilians present at the scene may not have experienced injury or exposure to a chemical agent, and may not require decon. Witnesses may fall into this category. After medical review, Command may direct such people to be documented and interviewed by Police Sector. Behavioral Health personnel may also interview such victims to offer assistance.
- V. Movement and loading of vehicles at the scene will be managed by Transportation Sector/Branch, with security/support from the Police Department as appropriate. Acquisition of additional vehicles and equipment will be handled through the Resource Sector/Branch.

**PHOENIX REGIONAL
STANDARD OPERATING PROCEDURES**

**HAZARDOUS MATERIALS WEAPONS OF MASS DESTRUCTION
CHEMICAL, BIOLOGICAL, RADIOLOGICAL-- RESPONSE OPERATIONS**

M.P. 207.01A

07/03-N

Page 12 of 14

- VI. If the local hospital system is overwhelmed early in an incident, or treatment requires it, patients may be moved to the NDMS Patient Reception Center (PRC). Patients will not be transported from the scene until the Transportation Officer has confirmed that the PRC is operational. The chain of treatment will be continued at the PRC until patients are placed on aircraft. Patients transferred to NDMS will be tracked through their triage tags.

Hospitals

- I. Potential receiving hospitals will be notified immediately by dispatch (EMSystem and MCMAS) upon determination that a WMD agent is involved in an incident.
- II. Receiving hospitals will engage lock-down status.
- III. Hospitals will receive information on the probable (or identified) agent, decontamination guidance, and recommendations on patient care from toxicology/poison control personnel based in the City EOC. The priority will be to disseminate this information to receiving hospitals first, and then to all area hospitals. Once established MCMAS and EMSystem will enable simultaneous communication to all hospitals.
- IV. Medical Branch will coordinate with the pharmaceuticals representative in the EOC , and deliver appropriate drugs, antidotes and equipment (as adjuncts to those maintained at hospitals) to receiving hospitals.
- V. Hospitals will assume responsibility for decontamination, triage and treatment of “walk in” patients. This includes primary set-up of decontamination and maintenance of PPE for hospital personnel. A PFD unit (with appropriate PPE) trained in decontamination set up and procedures may be dispatched as scene demands de-escalate to each receiving hospital to assist in decontamination of walk-ins. Hospitals will handle medical triage for walk-ins and assume tracking responsibility for patients not processed through the scene.
- VI. The Phoenix Police Department will dispatch units with appropriate PPE as necessary to assist hospital security personnel in maintaining order at receiving facilities. This includes isolation and management of self-referrals awaiting decontamination.
- VII. Medical staff at receiving hospitals will determine patient treatment needs and the nature of definitive care. A medical decision may be made to refer the patient to the NDMS for transportation to definitive care. In this event, hospital transportation, supported as appropriate by Fire Department ambulances, will be arranged to transfer the patient(s) to NDMS at Sky Harbor International Airport. Hospital patients being moved who require continuing care and/or treatment between the time of hospital departure and the time they can be loaded on aircraft will obtain that treatment in the Patient Reception Center (PRC).

**PHOENIX REGIONAL
STANDARD OPERATING PROCEDURES**

**HAZARDOUS MATERIALS WEAPONS OF MASS DESTRUCTION
CHEMICAL, BIOLOGICAL, RADIOLOGICAL-- RESPONSE OPERATIONS**

M.P. 207.01A

07/03-N

Page 13 of 14

- VIII. Individual hospitals will determine their patient capacity and coordinate that information with the EOC and Transportation Sector at the scene. When a hospital closes due to maximum patient load, victims will be transported to other receiving hospitals. In the event all area hospitals become saturated (and alternate treatment areas are either full or not established), victims from the scene will be transported to the NDMS receiving area at Sky Harbor International Airport.

RECOVERY/RESTORATION ACTIONS

The recovery and restoration phase begins after the last living patients have been transported from the scene. During this phase, it is expected that Federal response elements will arrive with specialized teams and equipment. Federal resources will support hazard monitoring, technical (equipment) and environmental decontamination, and site restoration.

Technical Decon of Response Personnel/Equipment and Shutdown

- I. Hazmat personnel continue to perform and/or supervise the technical personnel decon corridor.
- II. Hazmat personnel will establish and operate an equipment decontamination corridor to support restoration of equipment needed to re-establish essential services.
- III. Hazmat personnel will shut down the emergency decon operation and technical decon corridors as they complete operation.
- IV. Hazmat personnel will find/document uncontained runoff problems from decon corridors.
- V. Equipment and protocol for personnel and equipment decontamination are described in M.P. 204.14C.

Site Survey

- I. To the extent possible, Hazmat personnel will continue to monitor all equipment and areas suspected to be contaminated with available detection and identification devices. Hazmat will coordinate with Arizona Department of Environmental Quality (ADEQ) for additional monitoring assistance outside of the hot/warm zones.
- II. Hazmat personnel will document all runoff areas, apparatus and other locations suspected or identified as contaminated.

**PHOENIX REGIONAL
STANDARD OPERATING PROCEDURES**

**HAZARDOUS MATERIALS WEAPONS OF MASS DESTRUCTION
CHEMICAL, BIOLOGICAL, RADIOLOGICAL-- RESPONSE OPERATIONS**

M.P. 207.01A

07/03-N

Page 14 of 14

- III. When **biological agents** are involved, Hazmat teams will continue to collect samples of suspected contamination for evaluation by ADHS State Laboratory. PD will transport samples from scene to laboratory.
- IV. In **radiological incidents**, Hazmat personnel will coordinate with Arizona Radiation Regulatory Agency to establish that equipment and site have been successfully decontaminated.
- V. For **chemical agents**, areas and equipment that cannot be accommodated in the technical equipment decon corridor will be cleaned with a 5% bleach solution. A minimum solution contact time of 15 minutes will be observed, then area or equipment will be thoroughly rinsed and remonitored for contamination. The process will continue until monitoring indicates no contamination is present.
- VI. Hazmat personnel will provide technical assistance/support as requested to Maricopa County, State, and/or Federal agencies engaged in restoration operations. Such agencies will be operating under the Federal Response Plan.

Hazmat assist in transfer of deceased to County Medical Examiner

- I. Deceased are to be left in hot zone unit all victims have been transported.
- II. Maricopa County Medical Examiner's Office, supported by Federal D-Mort Teams, will examine bodies for evidence prior to decon. Decon may be supported by PFD Hazmat personnel as requested.
- III. Tracking, transportation and storage of bodies and belongings will be handled by the Medical Examiner's Office to insure preservation of chain of evidence custody.

**PHOENIX REGIONAL
STANDARD OPERATING PROCEDURES**

**WEAPONS OF MASS DESTRUCTION
CHEMICAL, BIOLOGICAL, RADIOLOGICAL
PERSONNEL AND EQUIPMENT DECONTAMINATION**

M.P. 207.01B

07/03-N

Page 1 of 5

The purpose of technical decontamination is to remove product/contaminates from personnel, apparatus and equipment. Specific measures may vary slightly with the WMD agent, level of contamination and circumstances of contamination. The Decontamination Sector Officer, through Command, is responsible for determining the most appropriate decontamination procedures and managing the decontamination process.

TECHNICAL DECON LINE PROCESS/STRUCTURE (PERSONNEL)

In an incident involving WMD/NBC three shelters will initially be constructed for grouped victims: Two Ambulatory and a Special Needs/Non Ambulatory decontamination shelter for victims requiring assistance, staffed by a male and female support group.

NOTE: Optimally, the Technical Decontamination Setup will be operated by six technicians

Station #1 - Personal Belongings Drop/Victim Accountability

Personnel Requirements: two station attendants

Equipment requirements: one large container, M256 Chemical Detection Kit, M8 chemical detection paper; Drager System; APD 2000 Chemical Agent Monitor; Victorian instrument CDU-700 and Ludlum Model IIC Radiacmeters plastic bags, triage tags and markers, and a container with soapy water, clipboard and pen.

Attendant #1 will have personnel tag and deposit all critical personal belongings (wallets, keys, identifications, money, purses etc.) into the large container. Attendant #2 will transfer the critical personal belongings into plastic bags and test for contamination with the appropriate sampling device based on the identified threat. If contents are contaminated, the attendant will decontaminate with soapy water and then re-monitor. Once the personal belongings are free of contamination, they will be moved to the exit point of the decontamination line for re-issue to the owners. For biological substances, MMRS toxicology personnel will provide guidance for re-issue. For victim accountability, attendant #1 will record names as individuals enter the technical decontamination procedure. A Start triage tag will be used for each individual.

Station #2 - Clothing Removal

Personnel Requirements: 1 station attendant

Equipment requirements: 1 large container and plastic bags.

Attendant #3 will have personnel remove all their clothing and deposit it into the lined container. Once the container is full, the bags will be sealed. These bags will be stored in the personal belongings check/decontamination area until all victims are processed.

Station #3 - Shower

Personnel Requirements: 1 station attendant

**PHOENIX REGIONAL
STANDARD OPERATING PROCEDURES**

**WEAPONS OF MASS DESTRUCTION
CHEMICAL, BIOLOGICAL, RADIOLOGICAL
PERSONNEL AND EQUIPMENT DECONTAMINATION**

M.P. 207.01B

07/03-N

Page 2 of 5

Equipment requirements: 2 shower systems, soapy water, sponge.

Attendant will have personnel enter the shower and ensure they wash all parts of their body paying particular attention to their hair and body folds. Attendant will have victims wash off any suspected contamination with soapy water and sponge, then re-rinse.

Station # 4 - Monitoring

Personnel Requirements: 1 station attendant

Equipment Requirements: M8 chemical detection paper; APD 2000 Chemical Agent Monitor; Victorian instrument CDU-700 and Ludlum Model IIC Radiacmeters.

Station attendant will monitor with the appropriate detection device for the identified contaminant. If any contamination is detected, the person will move back into the shower and rewash, then be retested. Once victims are tested and determined to be free of contamination, they will be sent forward to the clothing issue area.

Station # 5- Clothing issue/Redress

Personnel Requirements: 1 station attendant

Equipment requirements: Appropriate number of hospital scrubs and thongs for all personnel processing through decontamination

Attendant will issue the appropriate sized hospital scrubs and thongs to each person and have them redress.

The Decontamination Sector Officer will release individuals who have been processed through the decontamination corridor to the Medical Sector staff for further evaluation. This includes all emergency response personnel, civilians and patients. The Decontamination Sector Officer will determine when it is appropriate to release custody of clothing, personal effects and equipment after consulting the Treatment Sector Officer.

**PHOENIX REGIONAL
STANDARD OPERATING PROCEDURES**

**WEAPONS OF MASS DESTRUCTION
CHEMICAL, BIOLOGICAL, RADIOLOGICAL
PERSONNEL AND EQUIPMENT DECONTAMINATION**

M.P. 207.01B

07/03-N

Page 3 of 5

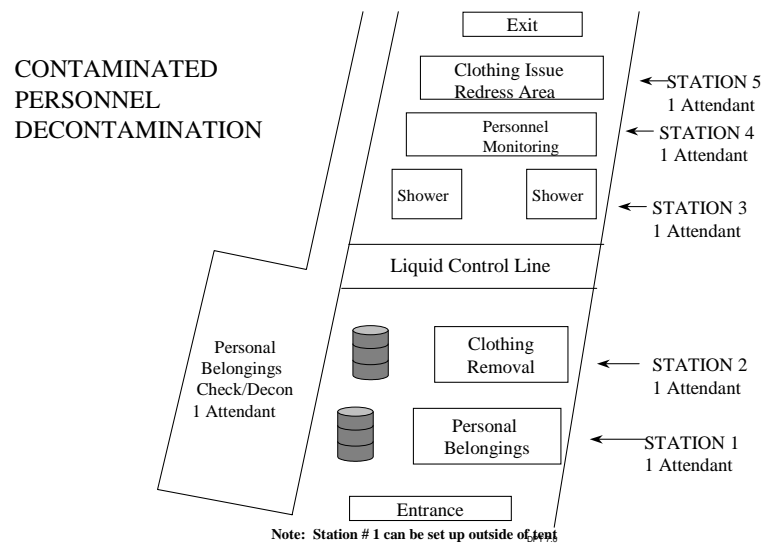

NOTE: Optimally, the Technical Decontamination Setup will be operated by 5 technicians

TECHNICAL DECON LINE PROCESS/STRUCTURE (EQUIPMENT)

Station #1 - Initial Wash

Personnel Requirements: 1 station attendant

Equipment requirements: Appropriate booster lines and nozzles

Station attendant will spray the vehicle and/or equipment for two to three minutes with water. Hot water, if available, is more effective at removing residual contaminants. Although undersurfaces are difficult to reach, they must be sprayed.

Station #2 - Decon Solution Application

Personnel Requirements: 1 Station attendants

Equipment Requirements: Spray devices, 5% Chlorine bleach solution, brushes

Station attendant will apply the decon solution to all areas of the equipment suspected of being contaminated. Make special effort to apply decon solution to undercarriage of vehicles driven in or through a contaminated area, particularly apparatus used in emergency gross decontamination.

**PHOENIX REGIONAL
STANDARD OPERATING PROCEDURES**

**WEAPONS OF MASS DESTRUCTION
CHEMICAL, BIOLOGICAL, RADIOLOGICAL
PERSONNEL AND EQUIPMENT DECONTAMINATION**

M.P. 207.01B

07/03-N

Page 4 of 5

Station #3 - Wait (Solution Contact Time)

Personnel Requirements: 1 Station Attendant

Equipment Requirements: Spray devices, 5% Chlorine bleach solution, brushes

Station attendant will allow the solution to stay on the vehicles/equipment for a minimum of fifteen minutes. Throughout the wait time, the attendant will observe the equipment and re-spray areas that dry from sunlight, heat or evaporation.

Station #4 - Rinse

Personnel Requirements: 1 Station attendants

Equipment Requirements: Appropriate booster lines and nozzles

Station attendant will spray vehicles and/or equipment for two to three minutes, paying particular attention to undersurfaces.

Station #5 - Equipment Monitoring

Personnel Requirements: 1 station attendants

Equipment Requirements: M8 chemical detection paper; Drager System; APD 2000 Chemical Agent Monitor; Victorian instrument CDU-700 and Ludlum Model IIC Radiacmeters

Station attendant will use the appropriate detection device to monitor for complete removal/neutralization of the identified contaminant. If Federal Agencies on the scene provide additional certification of decontamination, their process/requirements will be accommodated.

PHOENIX REGIONAL
STANDARD OPERATING PROCEDURES

WEAPONS OF MASS DESTRUCTION
CHEMICAL, BIOLOGICAL, RADIOLOGICAL
PERSONNEL AND EQUIPMENT DECONTAMINATION

M.P. 207.01B

07/03-N

Page 5 of 5

CONTAMINATED
EQUIPMENT
DECONTAMINATION

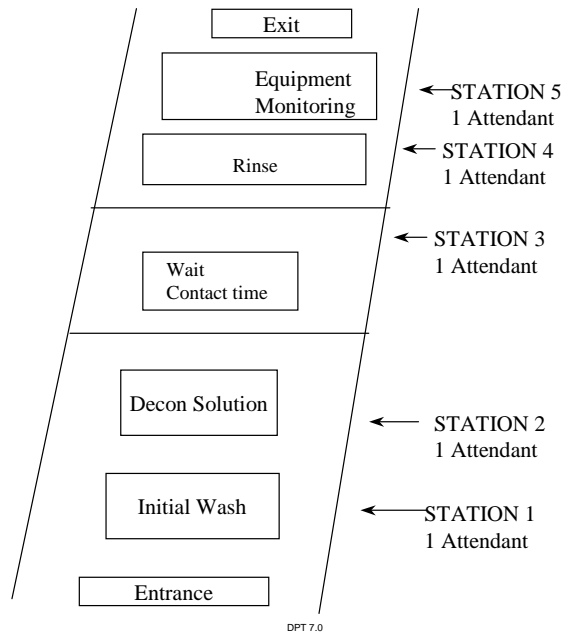

PHOENIX REGIONAL
STANDARD OPERATING PROCEDURES

**Weapons of Mass Destruction:
Chemical, Biological, Radiological
NBC Agent Descriptions and Treatment Protocols**

M.P. 207.01C

04/18

Page 1 of 13

Treatment protocols described here include drugs and procedures that are administered both by pre-hospital (CEP) personnel and hospital personnel. Thus, some drug administrations and procedures are outside the paramedic scope of practice.

The following treatment protocols have been reviewed by the PFD Medical Director, members of the Board of Directors of Arizona Emergency Medical Services (the regional emergency medical services association for physicians), and Maricopa County Public Health Department Medical Director. Network hospital personnel (physicians) were also consulted in developing and modifying the protocols.

Treatment protocols for radiological/nuclear agents are addressed in Phoenix Regional Department Standard Operating Procedure *M.P. 204.03 Radiological Hazards* and are not included here.

Agents Addressed

- Chlorine
- Hydrocyanic Acid, Hydrogen Cyanide & Cyanogen Chloride
- Methyl Isocyanate, Methylene Bisphenyl Isocyanate & Methylene Dilsocyanate
- Mustard (Sulfur Mustard)
- Nerve Agents

Chlorine

Military Designation: CL

Description: Chlorine is found as an amber liquid or greenish-yellow gas with a very characteristic irritating, pungent odor. Chlorine is severely irritating to the skin, eyes, and respiratory tract. Although generally stored as a liquid, when released, the resulting gas is about two times heavier than air.

Non-Military Uses: Chlorine is used widely in industrial settings in the organic synthesis and manufacture of antifreeze agents, solvents, refrigerants, resins, bleaching agents, and other inorganic chemicals. There is an exceptionally wide use of chlorine in non-commercial and home settings as a cleaning agent, bleaching agent, bacteriostatic, and disinfecting agent. Storage of this substance in a variety of liquid and granular forms is widespread.

**PHOENIX REGIONAL
STANDARD OPERATING PROCEDURES**

**Weapons of Mass Destruction:
Chemical, Biological, Radiological
NBC Agent Descriptions and Treatment Protocols**

M.P. 207.01C

04/18

Page 2 of 13

Treatment Protocol

- General
 - Chlorine is found as a greenish-yellow gas, with a pungent, acrid, characteristic odor. Sensitivity to the odor is below toxic levels; however, since some sensory adaptation occurs, repeat exposures are more likely to produce toxic effects. Exposures irritate eyes and central (upper) airways within minutes. Low doses produce some cough and choking sensation. Moderate doses also produce a sense of suffocation, hoarseness, and substernal pain. High doses also produce a severe dyspnea, with pulmonary edema, nausea, vomiting, headache, syncope also seen. Very high doses may produce sudden death without an obvious pulmonary lesion, possibly via laryngospasm. All recognized exposures should be referred for direct observation/care.
- Patient Evaluation
 - Victims should be immediately removed from the toxic environment by fully masked personnel. Chemical protective clothing is required for liquid/solution exposures.
 - Liquid contamination causes eye and skin burns on contact. Contaminated clothing should be removed/disposed of.
- Treatment
 - Eyes: Liquid exposures should be flushed with copious quantities of water. Gas exposures, if symptomatic, should be flushed with water.
 - Skin: Liquid exposures should be flushed with copious quantities of water; contaminated clothing should be removed/disposed of. Gas exposures require no specific therapy unless symptomatic. Intense gas exposure produces burns; wash with water.
 - Breathing: Evaluate respiration, cyanosis, bronchospasm.
 - If apneic: CPR with intubation. Be aware that laryngospasm may be present with intense exposures, hence intubation may be very difficult, and surgical cricothyrotomy could be required. Medical attention should be sought.
 - If stridorous/hoarse: Consider intubation under direct vision since laryngospasm may be imminent (see above). Medical attention should be sought.

**PHOENIX REGIONAL
STANDARD OPERATING PROCEDURES**

**Weapons of Mass Destruction:
Chemical, Biological, Radiological
NBC Agent Descriptions and Treatment Protocols**

M.P. 207.01C

04/18

Page 3 of 13

- If dyspnea/cough/chest tightness: Consider intubation for impending pulmonary edema. Also consider possible bronchospasm sufficiently severe to have so little air exchange that wheezes are absent. Medical attention should be sought. Codeine-containing demulcents may help. Be wary of sedation.
- If bronchospasm: Provide aggressive bronchodilation:
 - Adult:
 - Inhaled albuterol: unit dose q 2 hr.
 - Steroids: methyl prednisone, load 120 mg IV, then 60 mg q 6 hr.
 - Theophylline: load 150 mg IV, then 30 mg/hr.
 - Infants and children (0-12 yr):
 - Inhaled albuterol: 0.15 mg/kg per nebulized dose up to 5 mg/20 minutes for first 2 hr.
 - Steroids: methyl prednisone: 1 mg/kg IV q 6 hr.
 - Theophylline: 10 mg/kg IV/24 hr.
 - Elderly:
 - Inhaled albuterol: unit dose q 3 hr.
 - Steroids: methyl prednisone, load 125 mg IV, then 60 mg q 6 hr.
 - Theophylline (occasional use): load 100 mg IV, then 25 mg/hr.
- If asymptomatic: Maintain direct observation for at least 1 hour; if becomes symptomatic, treat as above. If still asymptomatic, continue to recheck every hour for additional 12 hours since some bronchospasm may appear late.
- If hypoxic from bronchospasm, administer bronchodilators and supplemental oxygen. If hypoxic from pulmonary edema: oxygen may be utilized with positive pressure (ventilation after intubation).
- If pulmonary edema occurs: Treat as noncardiac pulmonary edema (Adult Respiratory Distress Syndrome or ARDS) with positive pressure ventilation afterwards. Diuretic therapy is not indicated.
- Inhalation exposures may produce pulmonary infiltrates, fever, and white blood cell elevations leading to an erroneous diagnosis of (presumed bacterial) pneumonia. Prophylactic antibiotics are not indicated. Surveillance bacteriologic cultures are obtained anticipating an approximate 50% risk of nosocomial pneumonia at days 3-6.

PHOENIX REGIONAL
STANDARD OPERATING PROCEDURES

**Weapons of Mass Destruction:
Chemical, Biological, Radiological
NBC Agent Descriptions and Treatment Protocols**

M.P. 207.01C

04/18

Page 4 of 13

- Note: The anatomical configuration of infants' and children's airways makes wheezing a less reliable indicator of bronchospasm. Severe small airway constriction with resultant hypoxia may be present. Any apparent infant or child respiratory distress should be immediately assessed with oximetry.

Hydrocyanic Acid, Hydrogen Cyanide and Cyanogen Chloride

Military Designations: AC (hydrocyanic acid) and CK (cyanogen chloride)

Description: Both of these substances are liquids, but they vaporize (evaporate) at about 73/F and 58/C, so they will be in the gaseous form under most temperate conditions. AC has an odor of bitter almonds; CK is pungent. AC vapor is lighter than air, whereas CK gas is heavier than air. Cyanogen chloride is quickly metabolized to cyanide once absorbed into the body and causes the same biological effects as hydrogen cyanide. In addition, CK is irritating to the eyes, nose, and throat (similar to riot control agents), whereas AC is nonirritating.

Non-Military Uses: Large amounts of cyanide (most in the form of salts) are produced, transported, and used by U.S. industry annually. Cyanide is used in fumigation, photography, extraction of metals, electroplating, metal cleaning, tempering of metals, and the synthesis of many compounds. It is released when synthetic fibers and plastics burn.

Treatment Protocol

- General
 - Patient should be removed from the toxic environment immediately.
 - These substances are very volatile, so there is little need for decontamination if exposure was to vapor alone. If liquid was present, remove patient's clothing; wash liquid off skin.
 - The effects of vapor from either form of cyanide appear within seconds to a minute. If patient has no or only mild effects when seen 5 to 30 minutes after exposure, he/she will need no treatment.
 - Severe cyanide poisoning produces metabolic acidosis. If cyanide poisoning is suspected in a patient who does not have moderate or severe acidosis, treatment for cyanide poisoning should not be delayed, but the diagnosis should be reconsidered

**PHOENIX REGIONAL
STANDARD OPERATING PROCEDURES**

**Weapons of Mass Destruction:
Chemical, Biological, Radiological
NBC Agent Descriptions and Treatment Protocols**

M.P. 207.01C

04/18

Page 5 of 13

- Patient evaluation (Level of consciousness, respiratory rate, heart rate)
 - Exposure to high concentration: transient hyperpnea, followed by convulsions (30 seconds after exposure), gradual decrease in respiratory rate and depth to apnea (3-5 minutes) and cessation of cardiac activity (5-8 minutes).
 - Exposure to lower concentration: flushing, headache, anxiety, agitation, vertigo, feeling of weakness, nausea, muscular trembling (cyanogen chloride may cause irritation of eyes, nose, and airways). Prolonged exposure may lead to effects listed above.
 - Odor of bitter almonds may be detected (half of the population cannot smell this); normal pupils (may be dilated in terminal stage); cherry-red skin (may not be present); diaphoresis; venules in fundus are same color as arterioles; cyanosis occurs only after circulatory collapse and apnea.
- Treatment
 - For a mild exposure (conscious and breathing): observe; no antidotes; oxygen may be given to young or old or in presence of heart disease in a patient with mild symptoms.
 - Severe exposure (unconscious, not breathing): should immediately receive 100% oxygen. Cardiac monitoring and evaluation of oxygen saturation should be done when possible. (Saturation will be normal even in severe casualty until terminal stage; however, additional oxygen may assist in therapy.) Antidotes should be administered as soon as possible (see below). It is important to note that pulse oximeter results are completely unreliable in the setting of methemoglobinemia, which is induced by amyl nitrite or sodium nitrite therapy.
 - For a severe exposure: ventilate using bag-valve-mask with one ampule of amyl nitrite (crushed) in bag; after several minutes, add another (crushed) ampule; keep adding an ampule every several minutes. This is a temporary measure until IV drugs can be given, but it may assist in recovery.
 - Administer 300 mg (10 ml) of sodium nitrite IV over 5 minutes. Flush line. [Children's dose: 0.2-0.3 ml/kg, or 6-9 mg/kg of the 3% solution. No separate recommendation for infants.
 - For elderly, use adult dose unless they are small and frail.] Be aware: Nitrites produce orthostatic hypertension, but a patient who can stand unaided does not need nitrite therapy.

PHOENIX REGIONAL
STANDARD OPERATING PROCEDURES

**Weapons of Mass Destruction:
Chemical, Biological, Radiological
NBC Agent Descriptions and Treatment Protocols**

M.P. 207.01C

04/18

Page 6 of 13

- Follow with 12.5 grams (50 ml) of sodium thiosulphate IV. [Children's dose: 0.4 mg/kg, or 1.65 ml/kg of the 25% solution. No separate recommendation for infants. Adult dose should be used for elderly unless they are small and frail. Use care giving nitrite in a patient with hypertension or heart disease.] (Amyl nitrite, sodium nitrite, and sodium thiosulfate are in the Pasadena (formerly Lilly) Cyanide Antidote Kit, the latter two in ampules of 300 mg/10 ml and 12.5 grams/50 ml. Use one-half dose in 20 minutes if no improvement. See instructions on top of Antidote Kit box.
 - If patient continues to remain apneic, intubate and continue oxygen through tube with assisted ventilation.
 - Transfer apneic or unconscious patients to medical facility.
 - Patients often recover rapidly unless CNS hypoxia has occurred.

Methyl Isocyanate, Methylene, Bisphenyl Isocyanate, and Methylene Dilsocyanate MDI

Military Designations: None

Description: Methylene Bisphenyl Isocyanate (MDI) is found as a solid in white to yellow flakes. Various liquid solutions are used for industrial purposes. There is no odor to the solid or the liquid solutions. The vapor is approximately eight times heavier than air. This chemical is a strong irritant to the eyes, mucus membranes, skin, and respiratory tract. This chemical is also a very potent respiratory sensitizer.

Non-Military Uses: Very large quantities of MDI are produced, transported, and used annually in the United States. Various industrial processes utilize MDI in production and usage of (poly)urethane foams, lacquers, and sealants. MDI is a commonly used precursor in the industrial production of insecticides and laminating materials. Noncommercial uses of polyurethanes such as in isocyanate paints or in cutting of uncured urethanes may also cause exposure. Thermal degradation of these substances may produce MDI as a combustion by-product.

**PHOENIX REGIONAL
STANDARD OPERATING PROCEDURES**

**Weapons of Mass Destruction:
Chemical, Biological, Radiological
NBC Agent Descriptions and Treatment Protocols**

M.P. 207.01C

04/18

Page 7 of 13

Treatment Protocol

- General
 - MDI is found as a solid, which has a melting point of 37 degrees C. Vapor exposures occur with liquids containing dissolved solid. Gas exposures may occur with high-temperature volatilization. Thermal decomposition produces carbon monoxide and oxides of nitrogen. Sensitivity to this substance (eye, nose irritation) occurs at concentrations five times higher than OSHA limits (0.2 mg/m³); hence toxic exposures may go unrecognized.
 - Exposures lead to:
 - Sensitizing effects: Respiratory sensitization may occur, particularly in individuals with known asthma, allergies, or recognized isocyanate sensitivity (e.g., TDI).
 - Irritant effects: Eyes, mucous membranes and skin may be irritated, particularly with prolonged, repetitive, or intense exposures. High concentrations may also produce cough, dyspnea, and lethal pulmonary edema.
- Patient Evaluation
 - Victim should be immediately removed from the toxic environment by personnel in chemically protective clothing. Vapor or gas hazards should be anticipated with full (positive pressure) masks. Liquid/solid contamination should be corrected by clothing removal and soap and water decontamination.
- Treatment
 - Eyes: There is no specific therapy appropriate. Liquid/solid exposures should be irrigated with copious quantities of water. Subsequently, symptomatic individuals should seek medical attention.
 - Skin: There is no specific therapy appropriate. Liquids/solids should be removed with soap and water. Single exposures are unlikely to create rashes unless previously sensitized. Intense exposure may produce a dermatitis and require referral.
 - Swallowing: Liquids/solids should be removed by induced vomiting in the conscious victim or by lavage otherwise.
 - Breathing: Symptoms due to sensitivity may be delayed up to 8 hr after exposure. Respiratory symptoms may appear with skin, ocular or GI exposure in previously sensitized individual.
 - If apneic: CPR, may require intubation for pulmonary edema. Consider severe bronchospasm in previously sensitized victim.
 - If stridorous/hoarse: Consider intubation under direct vision.

**PHOENIX REGIONAL
STANDARD OPERATING PROCEDURES**

**Weapons of Mass Destruction:
Chemical, Biological, Radiological
NBC Agent Descriptions and Treatment Protocols**

M.P. 207.01C

04/18

Page 8 of 13

- If dyspnea/cough/chest tightness: Consider intubation for impending pulmonary edema. Also consider possible bronchospasm sufficiently severe to have so little air exchange that wheezes are absent. Medical attention should be sought. Codeine-containing demulcents may help. Be wary of sedation.
- *Note:* The anatomical configuration of infants' and children's airways makes wheezing a less reliable indicator of bronchospasm. Severe smaller airway constriction with resultant hypoxia may be present. Any apparent infant or child respiratory distress should be immediately assessed with oximetry.
- If bronchospasm: Treat as asthma with inhaled albuterol. Bronchospasm may be particularly severe, especially in previously sensitized individuals.
- Treat aggressively:
 - Adults:
 - Inhaled albuterol: unit dose q 2 hr or continuous neb 15 g/hr.
 - Steroids: methylprednisolone load 250 mg IV, then 80 mg q 6 hr.
 - Theophylline: load 150 mg IV, then 30 mg/hr.
 - Infants and children (0-12 yr.):
 - Inhaled albuterol: 0.15 mg/kg per nebulized dose up to 5 mg/20 minutes for first 2 hr.
 - Steroids: methylprednisolone; 1 mg/kg q 6 hr.
 - Theophylline: 10 mg/kg IV/24 hr.
 - Elderly:
 - Inhaled albuterol: unit dose q 3 hr.
 - Steroids: methylprednisolone load 125 mg IV, then 60 mg q 6 hr.
 - Theophylline (occasional use): load 100 mg IV then 25 mg/hr.
- Upper airway obstruction: This is very rarely seen and only with intense exposures. Hoarseness and stridor suggest impending laryngospasm; consider intubation under direct vision.
 - If pulmonary edema (may rarely occur with intense exposures): Treat as non-cardiac pulmonary edema (Adult Respiratory Distress Syndrome or ARDS see PHOSGENE).
 - If hypoxia (commonly from bronchospasm, rarely from pulmonary edema): Treat with above bronchodilation and oxygen.
 - If cough: Codeine-containing demulcents (tissue-soothing agents) may help. Be wary of sedation.

PHOENIX REGIONAL
STANDARD OPERATING PROCEDURES

**Weapons of Mass Destruction:
Chemical, Biological, Radiological
NBC Agent Descriptions and Treatment Protocols**

M.P. 207.01C

04/18

Page 9 of 13

Mustard (Sulfur Mustard)

Military Designations: H; HD; HS

Description: Mustard is a “blister agent” that causes cell damage and destruction. It is a colorless to light yellow to dark brown oily liquid with the odor of garlic, onion, or mustard. It does not evaporate readily but may pose a vapor hazard in warm weather. It is a vapor and liquid hazard to skin and eyes, and a vapor hazard to airways. Its vapor is five times heavier than air.

Non-Military Uses: Sulfur mustard has been used as a research tool to study DNA damage and repair. A related compound, nitrogen mustard, was the first cancer chemotherapeutic agent and is still used for some purposes.

Treatment Protocol

- General
 - Mustard causes no immediate effects. The initial clinical effects of mustard (which usually involve the eyes, the skin, and the airways) appear 2 to 24 hours (usually 4 to 8 hours) after exposure to liquid mustard or to mustard vapor. However, liquid or vapor mustard penetrates the skin and mucous membranes and damages cells within minutes of exposure, so decontamination must be done immediately after exposure.
 - The patient should be immediately removed from the toxic environment.
 - If liquid contact, clothing should be removed, and skin decontaminated with soap and cool water, or thoroughly flushed with water alone. Eyes should be flushed with large amounts of saline. If exposure is to vapor alone, remove clothing.
 - If there is a history of definite exposure, patient should be taken to medical facility for observation.
- Patient evaluation: Initial effects (usually 2 to 24 hours after exposure)
 - Eyes: irritation, feeling of grit in eye, redness.
 - Skin: erythema (will progress to blisters 1 to 4 hours later if exposure was large).
 - Airways: irritation of nose, voice change, sinus pain, hacking cough. (Very rarely a patient might inhale an extremely large amount and start to have these effects plus dyspnea within 2 hours. This patient should be intubated, and assisted ventilation with oxygen should be started. This patient should be taken to the nearest appropriate hospital as quickly as possible.)

PHOENIX REGIONAL
STANDARD OPERATING PROCEDURES

**Weapons of Mass Destruction:
Chemical, Biological, Radiological
NBC Agent Descriptions and Treatment Protocols**

M.P. 207.01C

04/18

Page 10 of 13

- Treatment
 - There is nothing to do for these patients until effects appear except to decontaminate. Tissue is damaged within minutes, so decontamination must be done immediately.
 - Eyes: Any commercial eye solution may relieve the irritation from a mild exposure. More severe effects: A mydriatic b.i.d. or q.i.d. (depending on the length of action of the drug): a topical antibiotic b.i.d.; Vaseline on lid edges b.i.d.; sunglasses if photophobia is present. Topical steroids within the first 24 hours only may reduce inflammation. Control pain with systemic, not topical, analgesics. Visual loss is usually due to lid edema and blepharospasm, not eye damage.
 - Skin: A soothing lotion (e.g., calamine) for erythema. Leave small blisters intact. Unroof large blisters and irrigate denuded area at least t.i.d. followed by liberal application of topical antibiotic. Watch for infection. Fluid requirements are much less than those for thermal burns; do not overhydrate.
 - Airways: Steam inhalation and cough suppressants will generally relieve mild symptoms. A chemical pneumonitis (increased temperature, white blood count; chest x-ray findings) may develop after large exposure: intubation, assisted ventilation with oxygen (and possibly with PEEP or CPAP); bronchodilators; watch sputum at least daily for organisms (no antibiotics until organism is identified)
 - Systemic absorption of a large amount of mustard may cause bone marrow and gastrointestinal tract damage. Watch WBC, Hct daily; mustard damages bone marrow.

Nerve Agents

Tabun (GA); Sarin (GB); Soman (GD). None for GF and VX

Military Designations: GA, GB, GD, GF and VX

Description: Nerve agents are very toxic organophosphorus compounds that have biological activity similar to that of many insecticides. Their volatilities range from that of water to that of motor oil; they present a hazard from vapor and liquid. Under temperate conditions, the liquids are clear, colorless, and mostly odorless. They cause biological effects by inhibiting acetylcholinesterase, thereby allowing acetylcholine to accumulate and cause hyperactivity in muscles, glands, and nerves.

**PHOENIX REGIONAL
STANDARD OPERATING PROCEDURES**

**Weapons of Mass Destruction:
Chemical, Biological, Radiological
NBC Agent Descriptions and Treatment Protocols**

M.P. 207.01C

04/18

Page 11 of 13

Non-Military Use: There is no non-military use. Threat of human exposure exists in research laboratories, in storage facilities, and from terrorists.

Treatment Protocol

- General
 - Nerve agents are extremely toxic chemicals that cause effects by inhibiting the enzyme acetylcholinesterase, allowing excess acetylcholine to accumulate. This excess neurotransmitter then produces overstimulation and causes hyperactivity in muscles, glands and nerves the nerve agents are GA (Tabun), GB (Sarin), GD (Soman), GF, and VX. Their effects are identical.
 - Remove patient from contaminated atmosphere. If exposure was to vapor, remove clothing; if exposure was to liquid; remove clothing and wash skin with soap and water, or thoroughly flush with water alone.
- Patient evaluation
 - If patient is conscious, note ventilatory status and ask about nausea. If unconscious, note ventilatory status and heart rate (heart rate may be high, low, or normal in a nerve agent casualty).
 - Initial effects differ depending on whether exposure was to vapor or to liquid.
 - Vapor: Effects start within seconds to a minute or two.
 - Mild to moderate: Miosis, possible redness in eye, eye pain, complaints of dim or blurred vision, nausea, rhinorrhea, excess secretions, dyspnea (mild to severe).
 - Severe: Loss of consciousness, seizures, apnea, flaccid paralysis.
 - Liquid: Effects start in minutes (large exposure) to 18 hours (small exposure) after an asymptomatic interval.
 - Mild to moderate: Sweating and fasciculations at site of exposure; nausea, vomiting, diarrhea; weakness.
 - Severe: Same as for vapor, but after a 1- to 30-minute asymptomatic interval.

PHOENIX REGIONAL
STANDARD OPERATING PROCEDURES

**Weapons of Mass Destruction:
Chemical, Biological, Radiological
NBC Agent Descriptions and Treatment Protocols**

M.P. 207.01C

04/18

Page 12 of 13

- Treatment
 - Initial Management
 - Mild to moderate: Dyspnea should be treated with one or two doses of atropine IM or IV and 1 dose of pralidoxime (IV drip) initially, depending on severity of the dyspnea. (See paragraph B below for size of dose.) This should be supplemented with oxygen, particularly in infants, young children, and the elderly; healthy older children and adults will usually do well without it unless they have pulmonary or cardiac disease. Atropine dose should be repeated at 5-to 10-minute intervals until improvement is noted. Failure to respond, (i.e., no dry mouth, no decrease in secretions) confirms the need to administer additional doses of atropine. Gastrointestinal effects after liquid exposure are treated in the same manner. Do not treat for miosis (unless eye pain is severe) or rhinorrhea (unless severe).
 - Severe: Administer three doses of atropine IM (not IV in hypoxic patient) and start one dose of pralidoxime by slow (20 minutes) IV drip. (More rapid administration will cause hypertension.) (See paragraph B below for size of dose.) Intubate and ventilate with oxygen (initial ventilation will be difficult because of airway resistance; atropine will relieve this). Administer diazepam if convulsing. Suction for secretions. Repeat 1 dose of atropine (IM until hypoxia is improved, then IV) every 5 minutes until (a) secretions diminish or (b) airway resistance is less or is normal. Failure to respond, (i.e., no dry mouth, no decrease in secretions) confirms the need to administer additional doses of atropine. Monitor via pulse oximeter; cardiac monitoring should also be done (cardiac arrhythmias are uncommon after atropine is given). Acidosis may develop after seizures or after period of hypoxia and will require therapy. This patient should be transported to a hospital after stabilization (adequate drug therapy and initiation of ventilation).
 - Eyes: Do not treat miosis unless eye/head pain is severe. Use topical, not systemic, anticholinergic to relieve pain.
 - Recommended Doses
 - Atropine:
 - Older child and adult: 2 mg
 - Infant and young child: 0.02 mg/kg
 - Elderly: Use adult dose unless cardiac or pulmonary disease is present, or patient is small or frail; in latter instances, use 1 mg as standard, but be prepared to administer additional amounts more frequently.

PHOENIX REGIONAL
STANDARD OPERATING PROCEDURES

**Weapons of Mass Destruction:
Chemical, Biological, Radiological
NBC Agent Descriptions and Treatment Protocols**

M.P. 207.01C

04/18

Page 13 of 13

Pralidoxime (2-PAM):

- Older child and adult: 1 gram
 - Infant and young child: 25-50 mg/kg
 - Elderly: Adult dose unless cardiac or renal disease is present, patient has hypertension, or patient is small and frail; decrease dose by half in these patients but administer the other half 1 hour later if patient has not improved. Pralidoxime can cause hypertension when given rapidly IV. Slow administration over 20 minutes will minimize the hypertensive effect. After rapid administration, hypertension can be rapidly but transiently reversed by phentolamine (adult: 5 mg IV. child: 1 mg, IV).
- Further Care
- Mild to moderate: After vapor exposure, a patient who is breathing normally does not need to be hospitalized as he will not worsen. However, miosis should be followed until eyes are normal (4 to 6 weeks). After liquid exposure, a patient should be observed in hospital for 18 hours until all agent is absorbed from skin.
 - Severe: Continue to ventilate and to administer atropine following guidelines above. Treat acidosis if present. If patient has not had prolonged hypoxia, recovery of an unconscious patient will be gradual over 1 to 3 hours.

**PHOENIX REGIONAL
STANDARD OPERATING PROCEDURES**

Review and Revision Timeline

M.P. 208.01

12/18

Page 1 of 1

Purpose

The purpose of this procedure is to outline the process for initiating the review of Phoenix Regional Standard Operating Procedures (PRSOP).

Policy

The Phoenix Fire Department, with consideration from the Regional Operations Consistency Committee (ROCC), is responsible for the management of the PRSOP index as well as the M.P. Review Cycle. The M.P. Review Cycle is the ongoing review time frame identified for each procedure. Procedures are scheduled for review on a five-year cycle. Additionally, procedures may require review or revision secondary to training/studies/operations etc. before the 5-year review date.

Procedure

The Scheduled Review Date is the deadline for a procedure to complete the review process. The review of PRSOP's should begin 3-6 months prior to the Scheduled Review Date. The Phoenix Fire Department, with consideration from the ROCC, is responsible for initiating procedural reviews and making the necessary revisions to keep PRSOP's current. A review of a procedure may involve the following:

1. Revision of a procedure
2. Rewrite of a procedure
3. Addition of a new procedure
4. Deletion/removal of a procedure
5. Validation of a procedure

A revised date and the next scheduled review date shall be updated on Fire Point upon a procedure's completion of the review process.