



City of Phoenix
 PLANNING AND DEVELOPMENT DEPARTMENT

**Staff Report Z-3-19-1
 (19th Avenue and Rose Garden Lane PUD)
 April 9, 2019**

Deer Valley [Village Planning Committee](#) April 18, 2019
Meeting Date:
[Planning Commission](#) Hearing Date: May 2, 2019

Request From: [Ind. Pk. DVAO](#) (Industrial Park, Deer Valley Airport Overlay District) (5.50 acres)

Request To: [PUD DVAO](#) (Planned Unit Development, Deer Valley Airport Overlay District) (5.50 acres)

Proposed Use: Industrial Uses

Location: Northwest corner of 19th Avenue and Rose Garden Lane

Owner: Rose Garden Phoenix, LLC

Applicant/Representative: William Allison, Withey Morris, PLC

Staff Recommendation: Approval, subject to stipulations

<u>General Plan Conformity</u>			
<u>General Plan Land Use Map Designation</u>		Industrial	
<u>Street Map Classification</u>	19th Avenue	Major Arterial	65-foot west half street
	Rose Garden Lane	Minor Collector	33-foot north half street
<p><i>STRENGTHEN OUR LOCAL ECONOMY CORE VALUE; JOB CREATION; LAND USE PRINCIPLE: Support General Plan Land Use Map and zoning changes that will facilitate the location of employment generating uses in each of the designated employment centers.</i></p> <p>The proposal allows for an expanded list of industrial uses, allowing the attraction of new tenants to the existing buildings on site. This will provide for expanded employment opportunities within the larger Deer Valley employment center.</p>			

**STRENGTHEN OUR LOCAL ECONOMY CORE VALUE;
MANUFACTURING/INDUSTRIAL DEVELOPMENT; LAND USE PRINCIPLE:
Discourage the location of incompatible uses near base industrial clusters.**

The proposal provides expands the list of allowed uses but restricts those that are incompatible with the surrounding area, such as residential – this allows for the expansion of the employment center by reducing possible conflicts with adjacent uses.

STRENGTHEN OUR LOCAL ECONOMY CORE VALUE; AIRPOTS; LAND USE PRINCIPLE: Continue to carefully monitor and evaluate all future land uses around the airports, protecting the airport from incompatible development that could pose a safety hazard to aircraft passengers, or to individuals living or residing in those areas. Additionally, ensure that future land uses within the Sky Harbor Center area will be compatible with the safe operation of Sky Harbor International Airport.

The subject site is located within the Deer Valley Airport Overlay District, Area 1. The overlay district is intended to protect the health, safety and welfare of persons and property within the vicinity of Deer Valley Airport. The proposed development is a compatible land use to nearby airport operations.

Applicable Plans, Overlays, and Initiatives

[Deer Valley Airport Overlay](#)

See Background Item No. 7 below.

[Deer Valley Major Employment Center](#)

See Background Item No. 8 below.

[Complete Streets Guidelines](#)

See Background Item No. 9 below.

Surrounding Land Uses/Zoning		
	<u>Land Use</u>	<u>Zoning</u>
On Site	Industrial/Commerce Park	Ind. Pk. DVAO
North	Industrial/Commerce Park	Ind. Pk. DVAO
South	Industrial/Commerce Park	CP/GCP
East	Industrial	A-1 DVAO
West	Industrial/Commerce Park	Ind. Pk. DVAO

Background/Issues/Analysis

SUBJECT SITE

1. This request is to rezone 5.50 acres located at the northwest corner of 19th Avenue and Rose Garden Lane from Ind. Pk. DVAO (Industrial Park, Deer Valley Airport Overlay District) to PUD DVAO (Planned Unit Development, Deer Valley Airport Overlay District) to allow for expanded industrial uses.
2. The subject site is currently developed with two industrial buildings, originally developed under the Industrial Park zoning district. Industrial Park is an obsolete district within the City of Phoenix Zoning Ordinance and is now regulated by the provisions of the Commerce Park zoning. Under the Commerce Park (Business Park) district standards, building setbacks and height are legally non-conforming. The PUD request is intended to unify development standards to match existing built conditions on site, and expand the list of allowable uses to attract additional tenants.
3. The subject site is designated Industrial on the General Plan Land Use Map. The PUD is consistent with this Land Use Map designation.

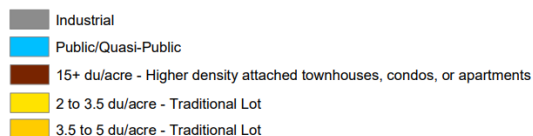
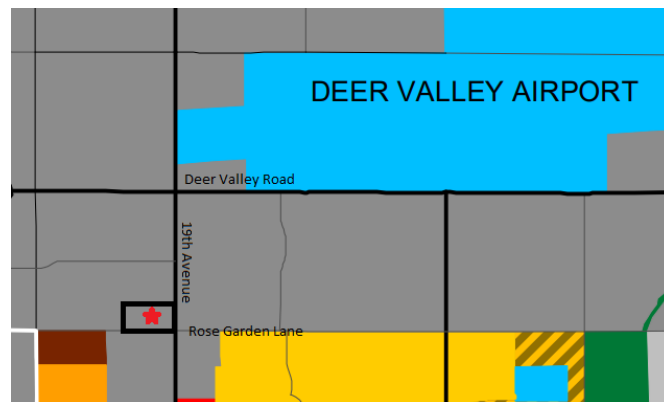

General Plan Land Use Map – Source: City of Phoenix Planning and Development Department

SURROUNDING USES AND ZONING

4. The subject site is a developed industrial/commerce park property currently zoned Ind. Pk. DVAO (Industrial Park, Deer Valley Airport Overlay District).

North of the subject site are existing industrial/commerce park buildings zoned Ind. Pk. DVAO (Industrial Park, Deer Valley Airport Overlay District).

South of the subject site are existing industrial/commerce sites and a gas station zoned CP/GCP (Commerce Park District/General Commerce Park).

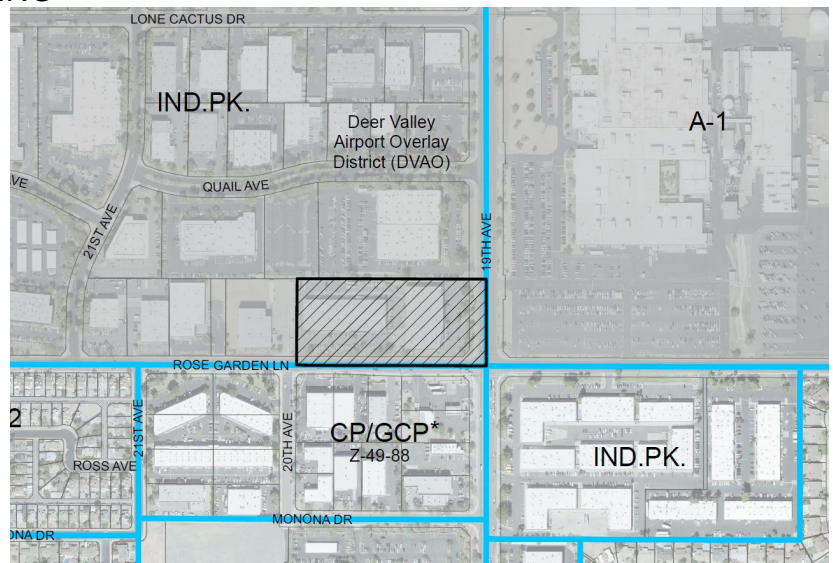

Source: City of Phoenix
Planning and Development
Department

East of the subject is a Honeywell industrial site, zoned A-1 DVAO (Light Industrial District, Deer Valley Airport Overlay District).

West of the subject site are existing industrial/commerce park buildings zoned Ind. Pk. DVAO (Industrial Park, Deer Valley Airport Overlay District).

PROPOSAL AND DEVELOPMENT STANDARDS

5. The proposal was developed utilizing the PUD zoning designation, which allows an applicant to propose uses, development standards and design guidelines for a site. One of the goals of this process is to allow the applicant to develop standards that respond to the surrounding environment more so than conventional zoning districts allow. The end result is property rezoned with standards crafted specifically for the site. Where the PUD narrative is silent on a requirement, the applicable Zoning Ordinance provisions will be applied.
6. Below is a summary of the proposed standards for the subject site as described in the attached PUD Development Narrative date stamped March 29, 2019. The proposed standards were designed to allow for industrial uses.

List of Uses

The Development Narrative proposes a number of permitted uses consistent with comparable zoning districts. The PUD allows uses from the CP/GCP (Commerce Park District, General Commerce Park) and A-1 (Light Industrial District) districts, while restricting those uses that are incompatible with the surrounding area, such as residential uses, intense industrial uses, and adult uses.

Conceptual Site Plan and Development Standards

The development's main ingress and egress points are along Rose Garden Lane, with two existing driveways. There is an existing driveway onto 19th Avenue at the north end of the site.

The proposed development standards have been developed to legalize existing built conditions on site, with setbacks and building height measured to the existing structures.

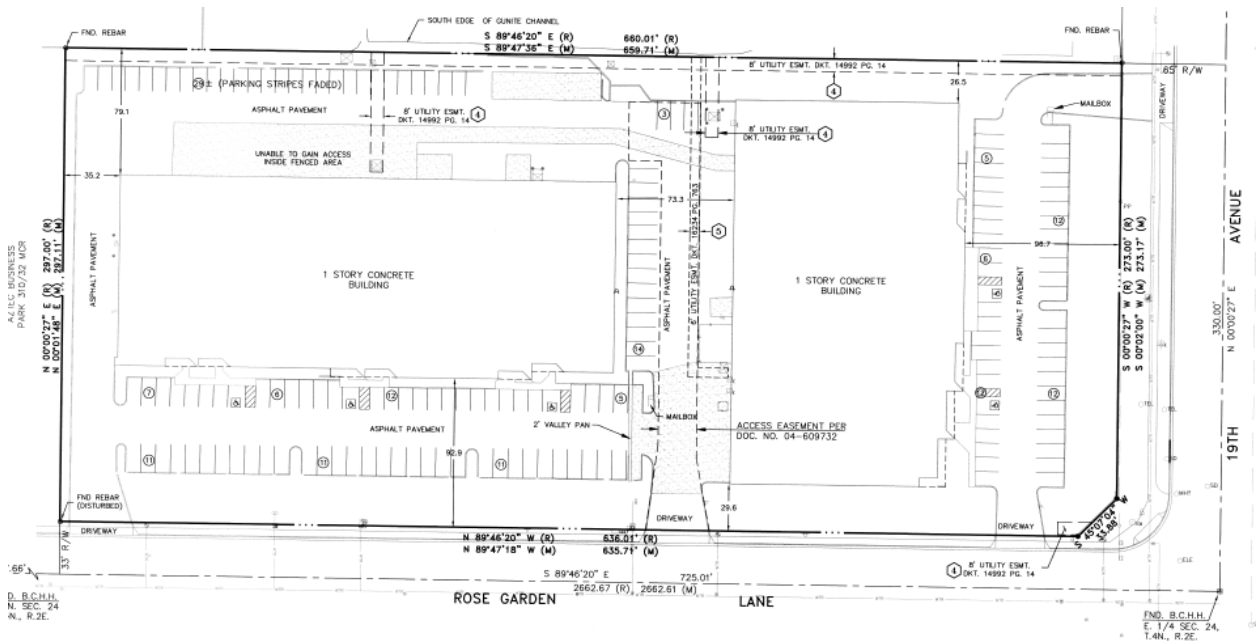

19th and Rose Garden Site Plan
Source: 19th and Rose Garden PUD
Development Narrative

Development Standard	Proposed PUD
Minimum Building Setbacks	29 feet from Rose Garden Lane; 30 feet from 19th Avenue; 20 feet from perimeter lot line not on a street; 0 feet from interior lot line not on a street
Height (Maximum), feet	28 feet within 26 feet of the north perimeter lot line; 29 feet for a building 35 feet from the west perimeter lot line; 29 feet within 29 feet of the south perimeter lot line; 18 feet within 30 feet of the east perimeter lot line; 1-foot increase per 3-foot additional setback, maximum 56 feet, or 80 feet with use permit and site plan.
Landscape Setbacks	As required by section 626 of the Zoning Ordinance

Landscape Standards

The PUD proposes landscaping standards unchanged from the requirements of the Commerce Park zoning district.

Sustainability

The PUD proposes a number of items to incorporate sustainability, including climate-sensitive materials, LED lightings, low-flow plumbing fixtures and drought-tolerant landscaping.

AREA PLANS, OVERLAY DISTRICTS AND INITIATIVES

7. Deer Valley Airport Overlay District

The Deer Valley Airport Overlay District is intended to protect the health, safety and welfare of persons and property in the vicinity of the Deer Valley Airport, and to protect the long-term viability of the Deer Valley Airport as a general aviation facility by ensuring land use compatibility with airport operations and protecting airspace from physical encroachment.

The PUD narrative is largely silent on the requirements of the Deer Valley Airport Overlay District. As stipulated, language will be added to clarify that the provisions of the overlay district remain in effect, while all other standards default to those found within the narrative. This is addressed in Stipulation No. 1.

8. Deer Valley Major Employment Center

The site is located in the Deer Valley Employment Center, along the Interstate-17 freeway and is in a predominantly commercial and industrial area. The site is also part of a limited amount of property remaining in the area, under private ownership, that has employment zoning.

9. Complete Streets Guiding Principles

In 2014, the City of Phoenix City Council adopted the Complete Streets Guiding Principles. The principles are intended to promote improvements that provide an accessible, safe, connected transportation system to include all modes, such as bicycles, pedestrians, transit, and vehicles. The proposal includes bike parking for employees and visitors to the site.

COMMUNITY INPUT SUMMARY

10. As of the writing of this report, staff has not received any correspondence regarding this proposed rezoning application.

INTERDEPARTMENTAL COMMENTS

11. The Street Transportation Department has reviewed the proposed request and does not have comments or stipulations at this time.
12. The Floodplain Management division of the Public Works Department has determined that this parcel is not in a Special Flood Hazard Area (SFHA), but is located in a Shaded Zone X, on panel 1290 L of the Flood Insurance Rate Maps (FIRM) dated June 2, 2017.
13. The Fire Prevention division of the Fire Department does not anticipate any problems associated with this rezone case but shall require the site and/or buildings to comply with the Phoenix Fire Code. The water supply (GPM and PSI) is not known at this location, and additional water supply may be required to meet the required fire flow per the Phoenix Fire Code.
14. The Parks and Recreation Department has reviewed the proposed site plan and rezoning request and does not have and comments or stipulations at this time.
15. The Water Services Department has reviewed the request and has determined that the property has water and sewer mains that can serve the development.
16. The Aviation Department has reviewed the request and determined that additional language must be added to address the provisions found within the Deer Valley Airport Overlay District. This is addressed in Stipulation Nos. 1, 2 and 3.
17. The site has not been identified as being archaeologically sensitive. However, in the event archaeological materials are encountered during construction, all ground disturbing activities must cease within 33-feet of the discovery and the City of Phoenix

Archaeology Office must be notified immediately and allowed time to properly assess the materials. This is addressed in Stipulation No. 4.

OTHER

18. As part of the Reimagine Phoenix initiative, the City of Phoenix is committed to increasing the waste diversion rate to 40 percent by 2020 and to better manage its solid waste resources. Section 716 of the Phoenix Zoning Ordinances establishes standards to encourage the provision of recycling containers for multifamily, commercial and mixed-use developments meeting certain criteria. The provision of recycling containers was not addressed in the applicant's submittal.
19. Development and use of the site is subject to all applicable codes and ordinances. Zoning approval does not negate other ordinance requirements. Other formal actions such as, but not limited to, zoning adjustments and abandonments may be required.

Findings

1. The request is consistent with General Plan Land Use Map designations and several General Plan goals and principles.
2. The proposed development is appropriate at this location and is consistent with the scale and existing zoning in the surrounding area.
3. The development will provide continued employment opportunities within an existing employment center.

Stipulations

1. An updated Development Narrative for the 19th Avenue and Rose Garden PUD reflecting the changes approved through this request shall be submitted to the Planning and Development Department within 30 days of City Council approval of this request. The updated Development Narrative shall be consistent with the Development Narrative date stamped March 29, 2019, as modified by the following stipulations:
 - a. Front Cover: Remove "Submittal" dates and revise to add the following: City Council adopted: [Add adoption date]. Correct location to read "Northwest corner of 19th Avenue and Rose Garden Lane."
 - b. Page 4: Correct language to read: "Provisions not specifically regulated by this PUD are governed by the Phoenix Zoning Ordinance, including the Deer Valley Airport Overlay (DVAO) District. If there are conflicts between specific provisions of this PUD, and the Phoenix Zoning Ordinance or

design guidelines, with the exception of the provisions of the DVAO, the terms of this PUD shall apply.”

- c. Page 5: Correct C.1 language to read: This PUD allows all uses permitted in the CP/GCP and A-1 zoning districts of the Phoenix Zoning Ordinance, except the following uses in C.2, which shall be prohibited. Add new section heading and introduction sentence for C.2 Prohibited Uses.
 - d. Page 7: Change section subheading from C.2 to C.3. Change section subheading from C.3 to C.4.
2. The developer shall provide documentation to the City prior to final site plan approval that Form 7460-1 has been filed for the development and that the development received a “No Hazard Determination” from the FAA. If temporary equipment used during construction exceeds the height of the permanent structure a separate Form 7460-1 shall be submitted to the FAA and a “No Hazard Determination” obtained prior to the construction start date.
 3. The subject site is within DVAO “Area 1”, development must provide Avigation Notice consistent with DVAO part 658.D.
 4. In the event archaeological materials are encountered during construction, the developer shall immediately cease all ground disturbing activities within a 33-foot radius of the discovery, notify the City Archaeologist, and allow time for the Archaeology Office to properly assess the materials.

Writer

Cody White

April 9, 2019

Team Leader

Samantha Keating

Exhibits

Zoning sketch

Aerial

19th and Rose Garden PUD Development Narrative (Date Stamped March 29, 2019)

<https://www.phoenix.gov/pdd/pz/pzservices/pud-cases>

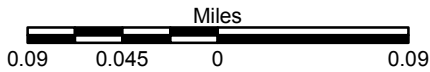
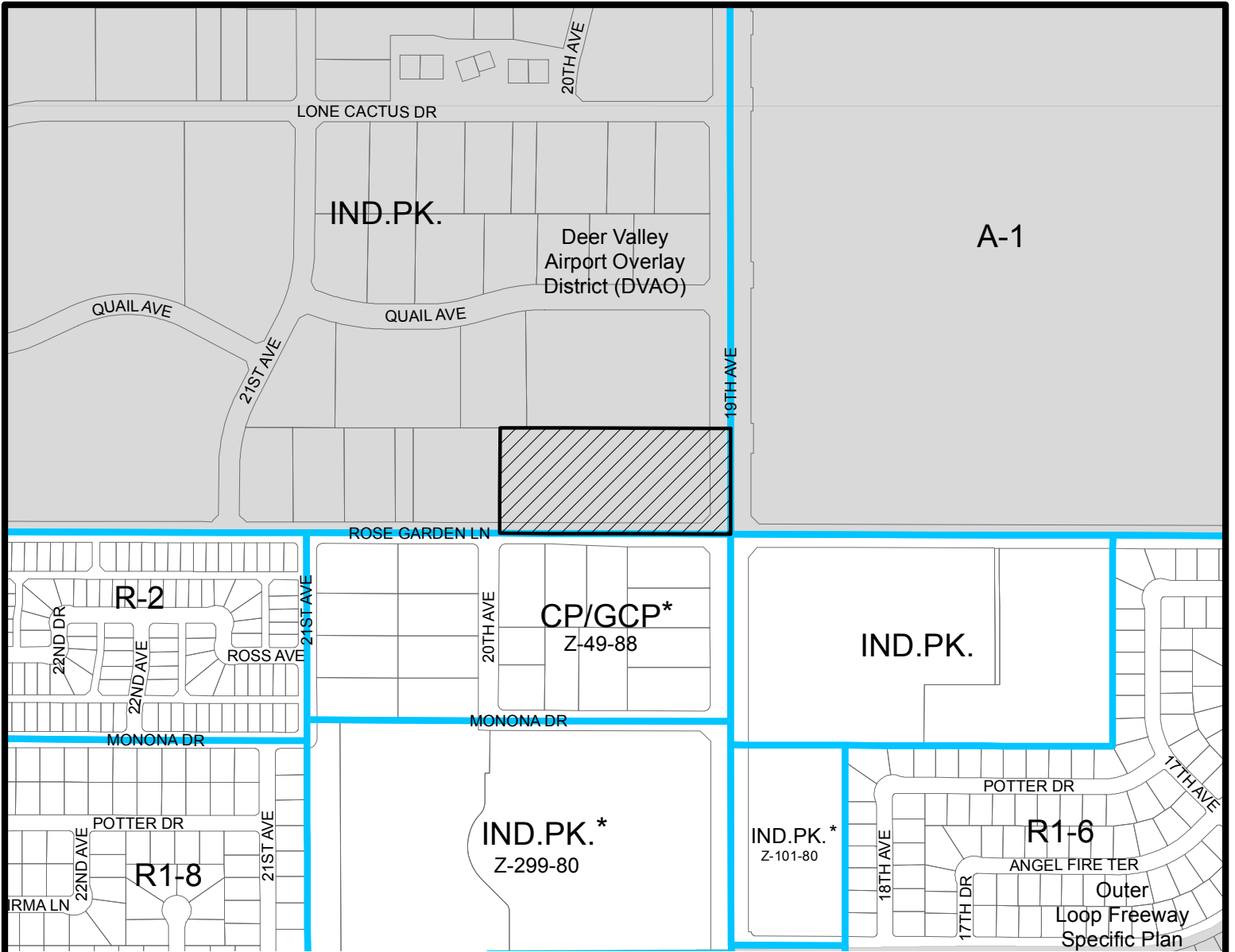

DEER VALLEY VILLAGE
CITY COUNCIL DISTRICT: 1

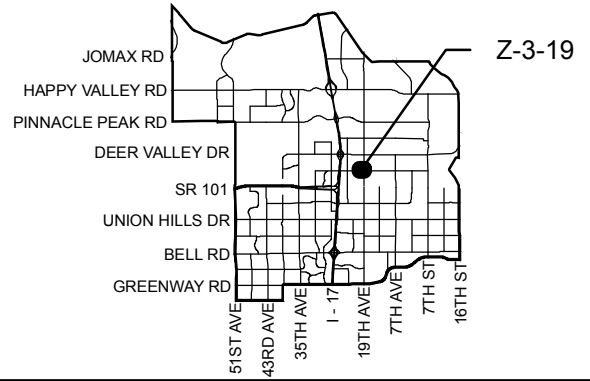

APPLICANT'S NAME: Withey Morris PLC, William F Allison		REQUESTED CHANGE:	
APPLICATION NO. Z-3-19		FROM: IND.PK. DVAO (5.50 a.c.)	
DATE: 1/29/2019 <small>REVISION DATES:</small>		TO: PUD DVAO (5.50 a.c.)	
<small>GROSS AREA INCLUDING 1/2 STREET AND ALLEY DEDICATION IS APPROX.</small> 5.50 Acres			
<small>AERIAL PHOTO & QUARTER SEC. NO.</small> QS 42-24		<small>ZONING MAP</small> N-7	
MULTIPLES PERMITTED		* UNITS P.R.D. OPTION	
IND.PK. DVAO		N/A	
PUD DVAO		N/A	

* Maximum Units Allowed with P.R.D. Bonus

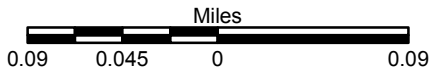
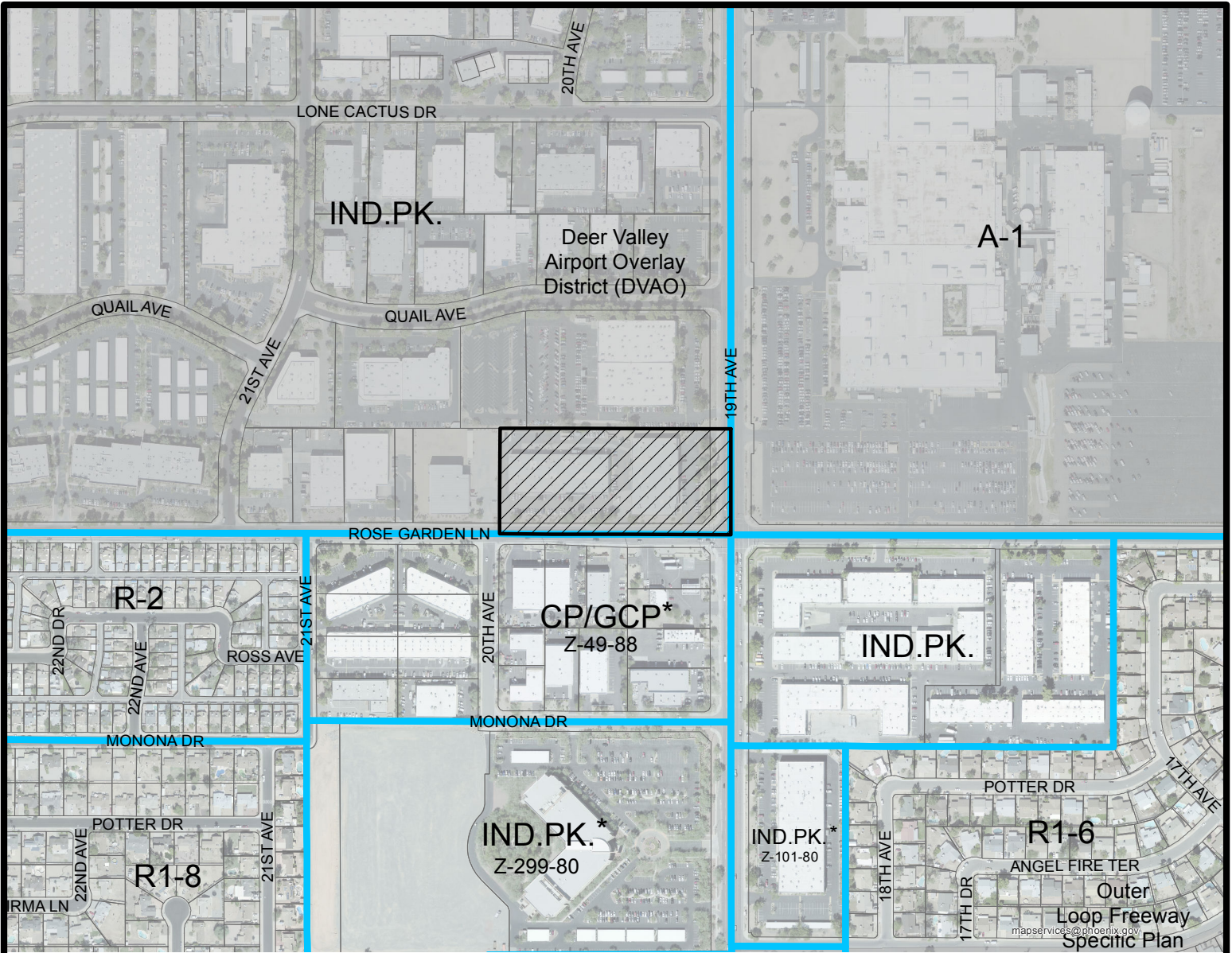

DEER VALLEY VILLAGE
CITY COUNCIL DISTRICT: 1

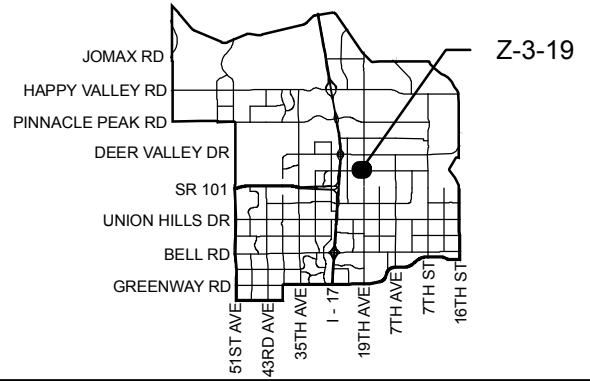

APPLICANT'S NAME: Withey Morris PLC, William F Allison		REQUESTED CHANGE:	
APPLICATION NO. Z-3-19		FROM: IND.PK. DVAO (5.50 a.c.)	
DATE: 1/29/2019 <small>REVISION DATES:</small>		TO: PUD DVAO (5.50 a.c.)	
<small>GROSS AREA INCLUDING 1/2 STREET AND ALLEY DEDICATION IS APPROX.</small> 5.50 Acres		<small>AERIAL PHOTO & QUARTER SEC. NO.</small> QS 42-24	<small>ZONING MAP</small> N-7
MULTIPLES PERMITTED		* UNITS P.R.D. OPTION	
IND.PK. DVAO		N/A	
PUD DVAO		N/A	

* Maximum Units Allowed with P.R.D. Bonus

Planned Unit Development

19th Avenue & Rose Garden Lane PUD

Land Use & Design Standards Narrative



Northeast corner of 19th Avenue and Rose Garden Lane

Zoning Case Z-3-19-1

1st Submittal: January 11, 2019

2nd Submittal: March 28, 2019

CITY OF PHOENIX

MAR 29 2019

**Planning & Development
Department**

Principals and Development Team

Property Owner:

Rose Garden Phoenix LLC

1545 Faraday Avenue

Carlsbad, CA 92008

Contact: Mark Hayden

Phone: 760-804-6900

Fax: 760-804-6901

Email: hayden@capstoneadvisors.com

Attorney/Applicant:

Withey Morris P.L.C.

2525 E. Arizona Biltmore Circle, A-212

Phoenix, Arizona 85016

Attorney: William F. Allison

Planner: Jessi Thornton

Phone: 602-230-0600

Fax: 602-212-1787

E-mail: bill@witheymorris.com

E-mail: jessi@witheymorris.com

TABLE OF CONTENTS

A.	Purpose & Intent.....	4
A.1	PUD Disclaimer.....	4
A.2	Project Overview and Goals.....	4
A.3	Overall Concept.....	4
B.	Land Use Plan.....	5
C.	List of Uses	5
C.1	Permitted Uses.....	5
C.2	Temporary Uses	7
C.3	Accessory Uses.....	7
D.	Development Standards	7
D.1	Development Standards Table.....	7
D.2	Landscape	8
D.3	Parking	8
D.4	Fences/Walls.....	8
D.5	Lighting.....	8
E.	Design Guidelines.....	8
F.	Signs	8
G.	Sustainability.....	8
H.	Infrastructure	9
H.1	Circulation	9
H.2	Grading & Drainage.....	9
H.3	Water Services	9
I.	Legal Description.....	9

LIST OF EXHIBITS

1.	Vicinity & Aerial Map.....	10
2.	Zoning Map.....	12
3.	General Plan Land Use Map	13
4.	Site Plan Exhibit	14

A. PURPOSE & INTENT

The purpose of the 19th Avenue and Rose Garden Lane (“PUD”) is to create a regulatory framework of specific standards that will guide the existing interim use and the future redevelopment of the existing industrial buildings located at the northwest corner of 19th Avenue and Rose Garden Lane (the “Property”). Provisions not specifically regulated by this PUD are governed by the Phoenix Zoning Ordinance, including the Deer Valley Airport Overlay District Area 1 restrictions on residential use and required Avigation Notice. If there are conflicts between specific provisions of this PUD, and the Phoenix Zoning Ordinance or design guidelines, the terms of this PUD shall apply.

A.1 PUD DISCLAIMER

A PUD is intended to be a stand alone set of zoning regulations for a particular project or property. Uses and standards that the PUD does not specifically regulate are governed by the Phoenix Zoning Ordinance and City Code. This PUD includes information to illustrate its purpose and intent; the purpose and intent statements are not necessarily requirement that Phoenix will enforce. The PUD modifies only zoning regulations that address the unique character of the subject project/property, site characteristics and location. The PUD does not modify other City Code requirements or other Phoenix regulations.

A.2 PROJECT OVERVIEW AND GOALS

This PUD represents an opportunity to maintain the existing buildings and provide opportunities for other potential industrial uses without outside storage. The Property Owner has initiated cosmetic improvements to the Property, including updated façade painting, renewed and improved maintenance of existing landscaping (including tree treeing), repairs to business identification signage, and repairs and improvements to existing parking and maneuvering areas. This PUD is intended to broaden the potential uses for an older industrial park development at the northwest corner of 19th Avenue and Rose Garden Lane, Phoenix. Since its initial construction in 1981, the standards for space in commerce park projects have changed, with greater emphasis on interior clear heights of the buildings, and different interior space planning/allocation. This 37-year-old property is in good condition and has more useful life. However, the limited list of uses allowed in the Commerce Park/Business Park option, to which the property’s Industrial Park zoning defaults, has adversely impacted, and will continue to impact, leasing options for the site. This PUD will increase the potential uses based on the A-1 zoning district use list with prohibitions of the more intense, outdoor industrial uses and other potentially impactful uses.

A.3 OVERALL CONCEPT

The purpose of this request is to enable a new chapter in the Property’s lifecycle by permitting and attracting industrial and other complementary uses. The request will update the zoning while providing the Property with the privileges afforded to surrounding Commerce Park/General Commerce Park and A-1/Light Industrial zoned properties. The development standards proposed are based on the Commerce Park/General Commerce Park standards and the existing development to ensure continued adherence to

the higher design standards of that district. The Property will continue to operate as-is until redevelopment as defined in Phoenix Zoning Ordinance Section 507 occurs.

B. LAND USE PLAN

The PUD proposes additional commercial and industrial uses but expressly prohibits most outside storage uses. Though no redevelopment is planned at this time, future redevelopment of the Property may include a variety of industrial uses with the need for greater interior clear heights, which will drive the future design concept.

The applicant is retaining the existing buildings, which have been enhanced recently with façade painting, signage and parking/maneuvering area improvements and improved landscape maintenance; no building expansions are proposed until redevelopment, should it occur. See Site Plan Exhibit. The existing buildings are intended for industrial and other complementary uses permitted under the CP/GCP and A-1 zoning districts.

The existing landscape has been improved with increased maintenance that enhances the streetscape. Until redevelopment occurs, there are no further improvements proposed on the Property or perimeter streets.



Existing landscape in front setback on 19th Avenue



Existing landscape in front setback on 19th Avenue

C. LIST OF USES

C.1 PERMITTED USES

This PUD allows all uses permitted in the CP/GCP and A-1 zoning districts of the Phoenix Zoning Ordinance, except the following uses, which shall be prohibited:

1. Adult bookstore, adult novelty store, adult theatre, adult live entertainment establishment, erotic dance or performance studio
2. Amusement Park or Other Outdoor Recreation Facility
3. Automobile Salvage
4. Brick Storage, Outdoors
5. Building Contractors, Equipment and Material Storage, Outdoors

6. Building Materials Storage, Outdoors
7. Bulk Material Storage, Outdoors
8. Bus Line Depot
9. Bus Terminal
10. Cement Storage, Outdoors
11. Cesspool Builders and Service: Equipment Yard
12. Concrete Products, Storage, Outdoors
13. Contracting Yards
14. Cranes, Storage Yard
15. Crop Dusting Equipment Yard
16. Dance Halls
17. Day Labor Hiring and Transportation Centers
18. Drilling Company, Equipment Yards
19. Equipment Storage and Yards, Outdoor
20. Flour and Grain Storage Elevators
21. Freight Yards
22. Fuel Distributing Station, Gasoline (bulk plant)
23. Gasoline, Bulk Storage Tanks
24. Grain Elevator
25. Hay and Straw, Sales, Storage, Outdoors
26. House Movers, Equipment Storage Yards
27. House Wreckers' Yards
28. Insulation, Contractors' Equipment Yards
29. Jobbers, Bulk Materials (sand, gravel, cotton seed, etc.), Outdoors
30. Landscape Contractors, Outdoors
31. Machinery Used, Storage, Outdoors
32. Meat Slaughtering, including rabbits and poultry
33. Medical Marijuana Cultivation
34. Medical Marijuana Dispensary Facilities
35. Medical Marijuana Infusion Production Facility
36. Mining Machinery, Wholesale Storage
37. Nonprofit Medical Marijuana Dispensary Facility
38. Oil, Fuel, Bulk Storage
39. All Outdoor Storage or Uses except in conformance to Section C.3 of this PUD
40. Public Utility Plant
41. Religious Missions, including charity dining halls and similar activities either enclosed or open
42. Residential Uses
43. Scales, Commercial Weighing
44. Storage Yards, Bulk Material
45. Storage Yards, Equipment
46. Trailer and Travel Trailer, Rentals and Sales
47. Well Drilling, Equipment Yard
48. Wrecking Contractors' Yards

C.2 TEMPORARY USES

Temporary uses shall be subject to Sections 627.H/Temporary Outdoor Storage Containers and 708/Temporary Uses of the Phoenix Zoning Ordinance.

C.3 ACCESSORY USES

Accessory uses shall be subject to Section 626.F/Commerce Park General Commerce Park of the Phoenix Zoning Ordinance, except as follows:

1. Outdoor display of vehicles for sale shall not exceed twenty (20) vehicles and shall not occur between the buildings on the site and the street.
2. Only short-term staging, weekend or overnight business vehicle storage shall be permitted. Such storage shall occur only behind the buildings on the site and shall not be visible from the street.
3. Outdoor display of merchandise shall be limited to 300 square feet, shall not exceed 10 feet in depth, shall not block pedestrian passage, shall not be located in required setbacks or in the parking lot, shall not include second hand/used merchandise and shall have all payment for merchandise conducted indoors.

D. DEVELOPMENT STANDARDS

D.1 DEVELOPMENT STANDARDS TABLE

The development standards of the Commerce Park/General Commerce Park District (Phoenix Zoning Ordinance Section 626.H) shall apply except as modified in the following table:

Standard	
Minimum Building setbacks	29' from Rose Garden Lane; 30' from 19 th Avenue; 20' from perimeter lot line not on a street; and 0' from interior lot line not on a street
Max. Building Height	28' within 26' from the north perimeter lot line; 29' for a building 35' from the west perimeter lot line; and 29' within 29' of the south perimeter lot line; 18' within 30' of the east perimeter lot line; 1' increase per 3' additional setback, maximum 56' to 80' with use permit and site plan

D.2 LANDSCAPE

Landscape shall be provided in accordance with Phoenix Zoning Ordinance Section 626 and Section 507 Tab A §II.A.3.

D.3 PARKING

Parking shall be provided in accordance with Phoenix Zoning Ordinance Section 702. In addition, bicycle parking shall be provided at a ratio of one (1) space for each 15,000 square feet of gross floor area on the Property, with a minimum of two (2) bicycle parking spaces.

D.4 FENCES/WALLS

At the time of future redevelopment of the Property, all fences and walls shall comply with Phoenix Zoning Ordinance Sections 703 and 626.

D.5 LIGHTING

At the time of future redevelopment of the Property, lighting shall comply with lighting standards as provided in Phoenix Zoning Ordinance Sections 704 and 507 Tab A and Phoenix City Code Section 23-100.

E. DESIGN GUIDELINES

Improvements to and/or redevelopment of the Property will comply with Phoenix Zoning Ordinance Section 507 and, as applicable, Section 507 Tab A, Guidelines for Design Review.

F. SIGNS

Signs shall be provided in accordance with Phoenix Zoning Ordinance Section 705 for Commercial/Industrial Land Use.

G. SUSTAINABILITY

Future vertical redevelopment shall incorporate the following sustainability elements:

1. Building designs should respond to the southwest climate by incorporating materials and design methods suitable for the region. The project shall utilize low water use/drought tolerant landscaping.
2. Low VOC paints, carpet and flooring
3. LED/CFL lighting
4. Low flow plumbing fixtures shall be utilized
5. Landscaping shall include drought tolerant plantings with a drip irrigation system.

H. INFRASTRUCTURE

H.1 CIRCULATION

Access to the Property is provided from 19th Avenue and Rose Garden Lane through existing driveways.

H.2 GRADING & DRAINAGE

New vertical development shall conform to the City of Phoenix regulations and design guidelines.

H.3 WATER SERVICES

Water and wastewater infrastructure requirements are met under current improvements on site and in the right-of-way. The existing industrial and business park uses on the project site are served by the existing city of Phoenix water and wastewater systems. Future redevelopment of the site may require infrastructure improvements based on proposed uses and capacity demand at that time. The improvements will be designed and constructed in accordance with city Code requirements and Water Service Department Design Standards and Policies.

I. LEGAL DESCRIPTION

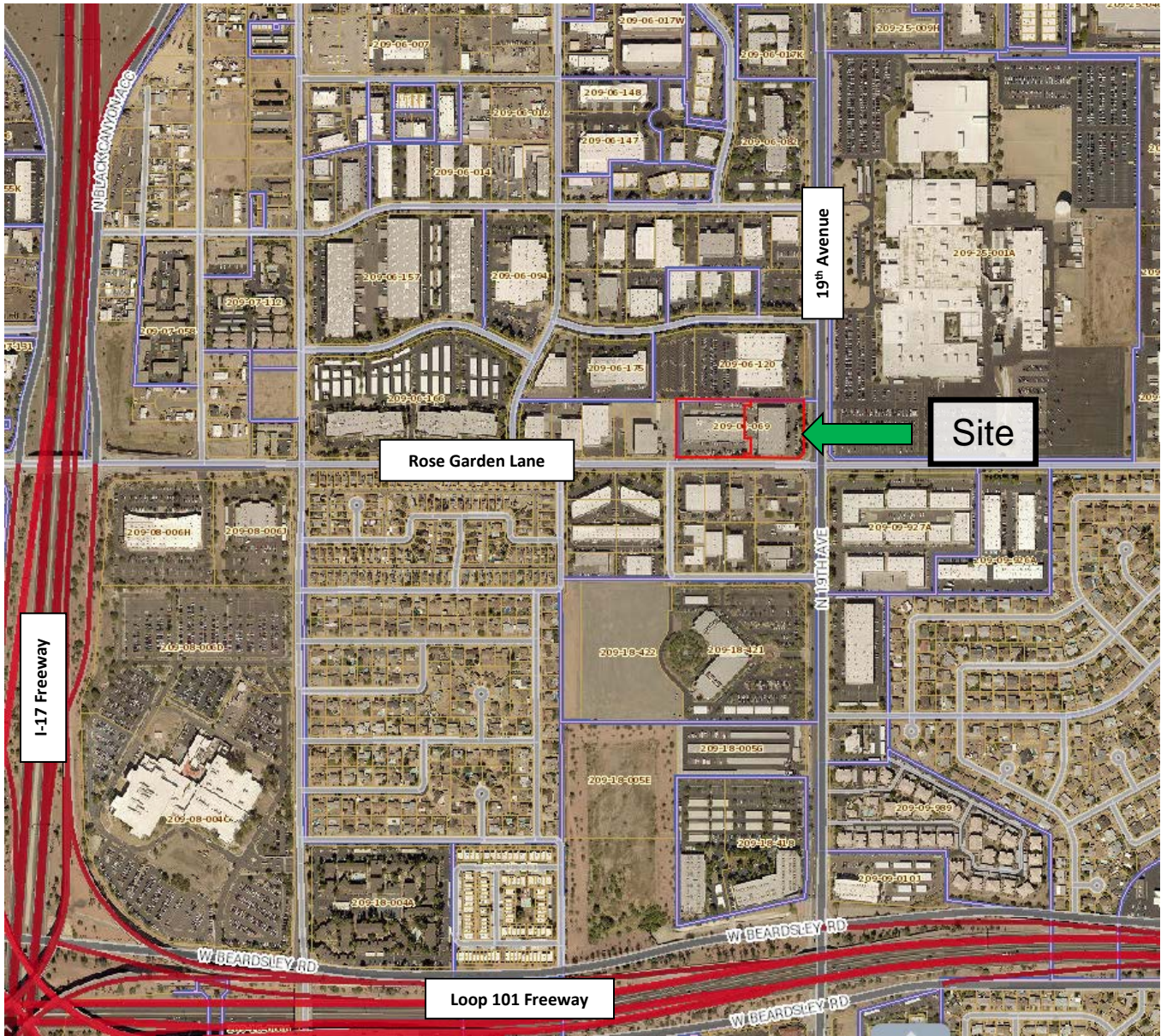

VICINITY MAP

Image Source: Maricopa County Assessor





AERIAL MAP

Image Source: Maricopa County Assessor



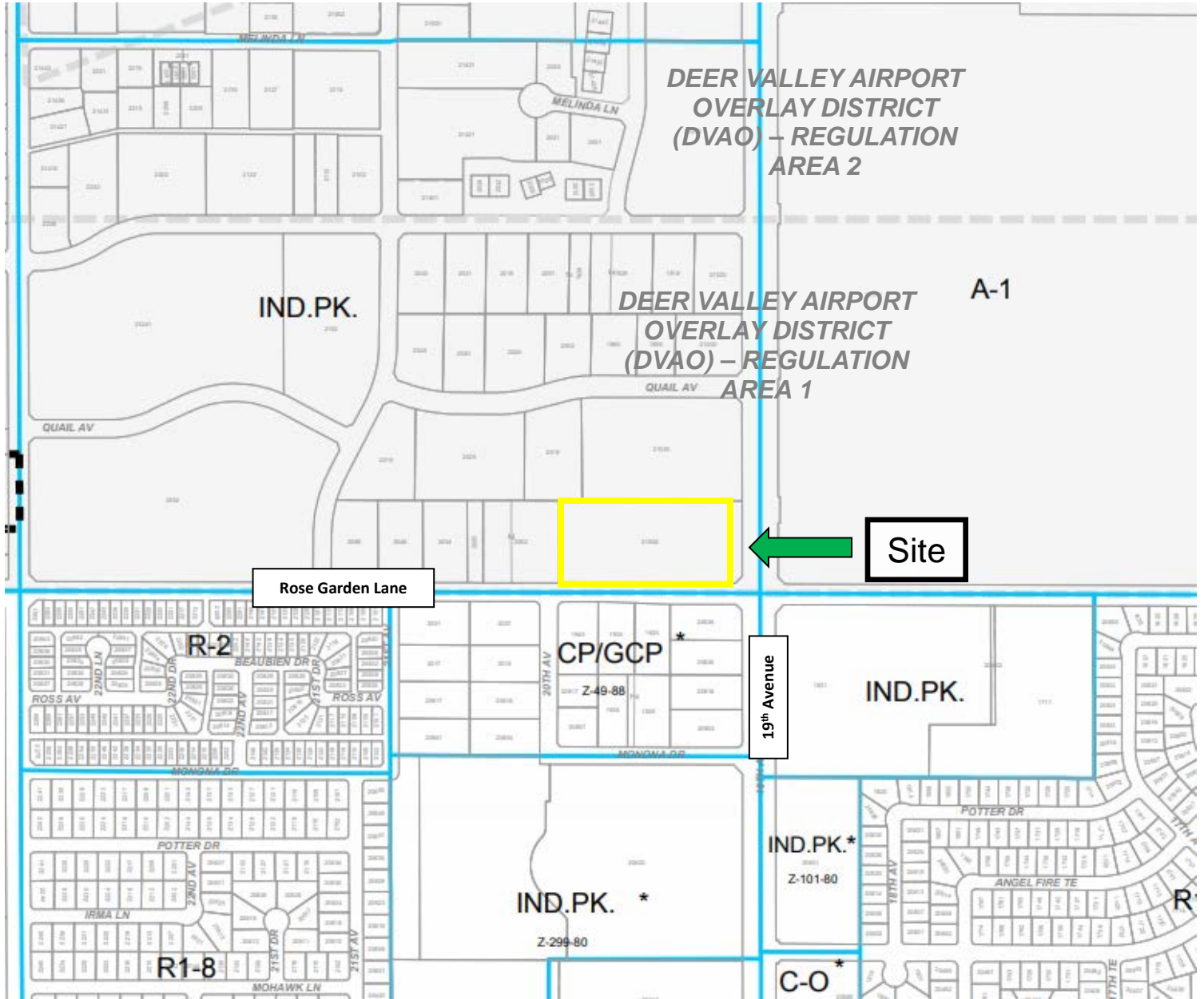

ZONING MAP

Image Source: City of Phoenix Zoning Maps



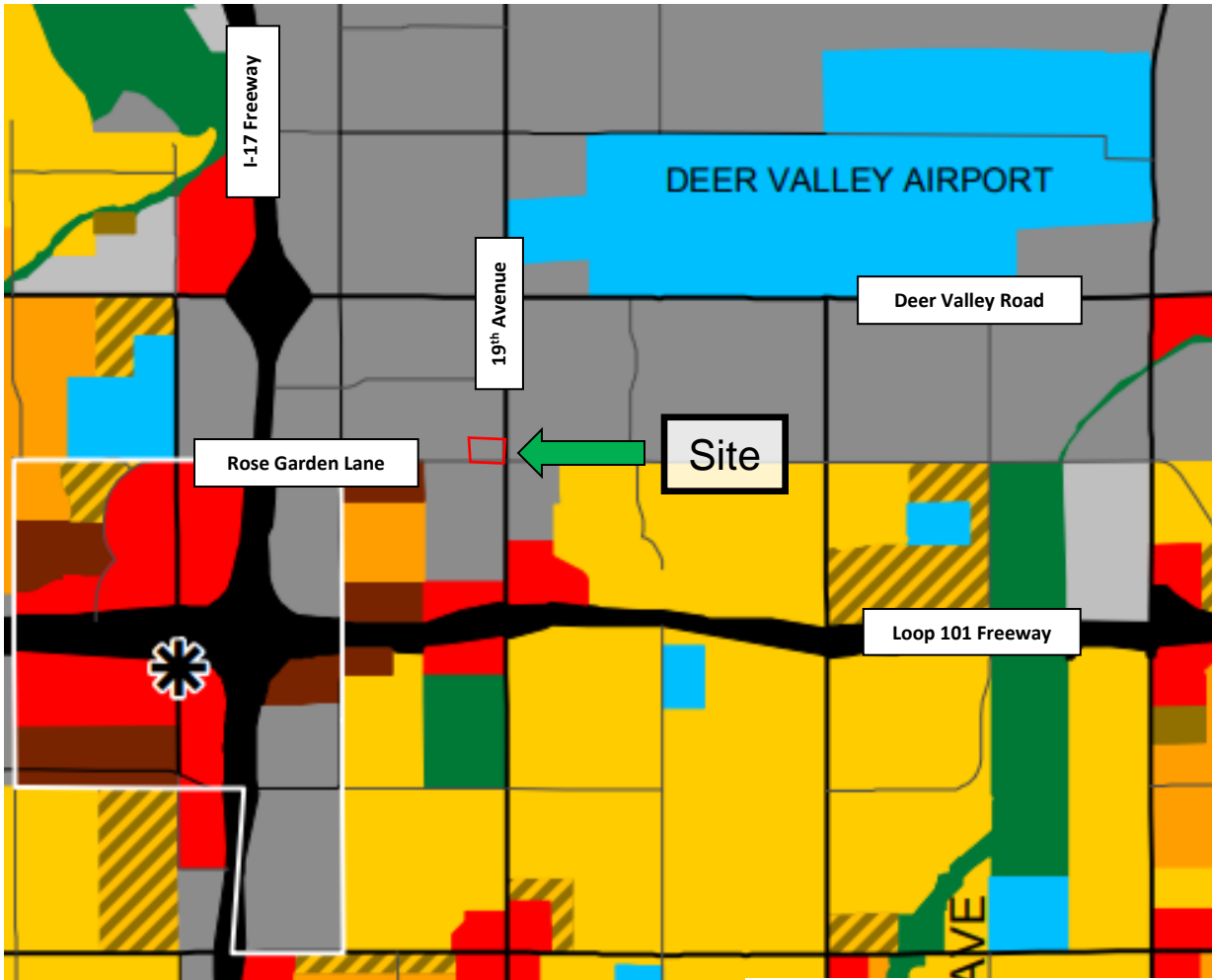

Image Source: City of Phoenix General Plan Map

GENERAL PLAN MAP

LAND USE

- 0 to 1 du/acre - Large Lot
- 1 to 2 du/acre - Large Lot
- 2 to 3.5 du/acre - Traditional Lot
- 3.5 to 5 du/acre - Traditional Lot
- 5 to 10 du/acre - Traditional Lot
- 10 to 15 du/acre - Higher density attached townhous
- 15+ du/acre - Higher density attached townhouses.
- Parks/Open Space - Publicly Owned
- Parks/Open Space - Privately Owned
- Future Parks/Open Space or 1 du/acre
- Mixed Use Agricultural
- Nurseries/Flower Gardens with alternative 3.5 to 5
- Commercial
- Mixed Use (MU)
- Mixed Use (Areas C, D and Northwest Area only)
- Industrial ←
- Commerce / Business Park
- Public/Quasi-Public
- Floodplain
- Undesignated Area

NOTE:
 Movement within large lot, traditional lot and higher density residential categories does not require a General Plan amendment.

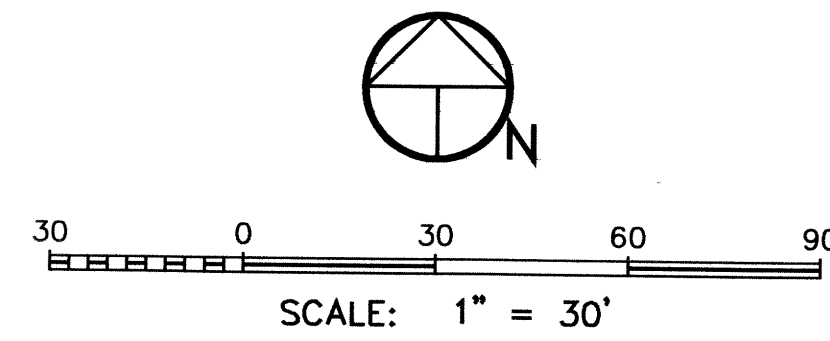

NOTES

- 1) FLOOD ZONE SUBJECT PROPERTY LIES WITHIN "ZONE X" DETERMINED TO BE AREAS OF MINIMAL FLOODING PER FEDERAL EMERGENCY MANAGEMENT AGENCY MAP NO. 04013C1215 J DATED JULY 19, 2001.
- 2) THERE IS NO EVIDENCE OF EARTH MOVING, CONSTRUCTION OR DUMPING WITHIN RECENT MONTHS.
- 3) ZONING & SETBACKS:
 ZONED: A-1 LIGHT INDUSTRIAL
 SETBACKS: FRONT 20'
 SIDE 10'
 REAR 25'
 (PER C.O.P. ZONING REGULATIONS)

VICINITY MAP N.T.S.

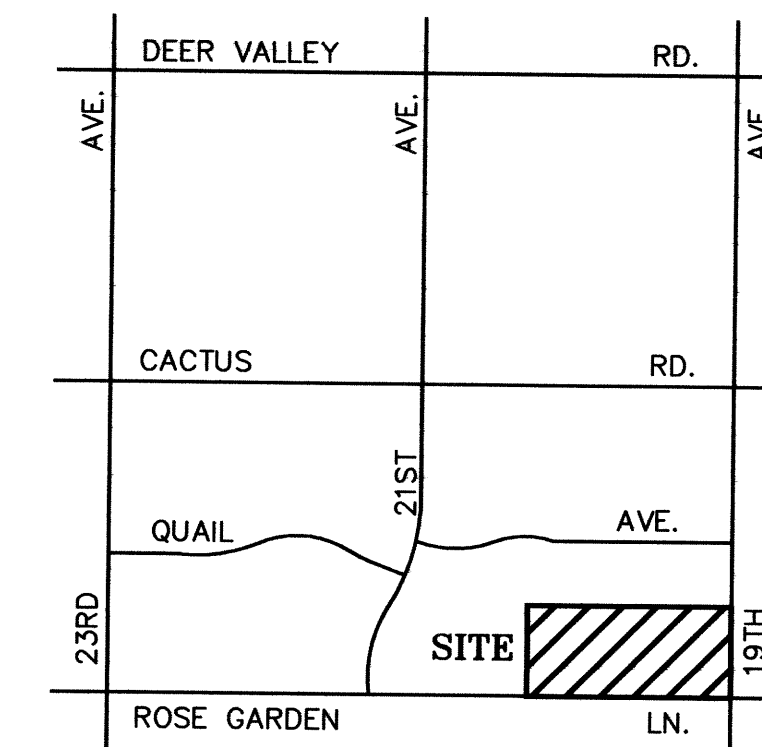

LEGEND

- SET PROPERTY CORNER 1/2" REBAR W/ CAP L.S. #17403 (U.N.O.)
- PROPERTY LINE
- - - FND. PROPERTY CORNER (AS NOTED)
- 2' VERT. CURB & GUTTER
- 6" CURB
- EDGE OF PAVEMENT
- MASONRY WALL
- SEWER MANHOLE
- FIRE HYDRANT
- ⊠ WATER METER
- WATER VALVE
- ⊠ BACK-FLOW PREVENTER
- ⊠ ELEC. TRANS. PAD
- ⊠ SITE LIGHT
- STREET LIGHT
- DRYWELL
- ⊠ CATCH BASIN
- ⊠ FIRE DEPT. CONNECTION
- ⊠ ELEC. PULL BOX
- ⊠ TELEPHONE RISER
- ⊠ TRAFFIC CONTROL BOX
- ⊠ GAS METER
- POWER POLE
- GUY WIRE
- ⊠ HANDICAP PARKING
- ⊠ CONCRETE SURFACE
- ⊠ SCHEDULE "B" ITEM
- ⊠ PARKING SPACE COUNT

LEGAL DESCRIPTION

LOT 1, ROSE GARDEN CENTER, ACCORDING TO BOOK 228 OF MAPS, PAGE 20, RECORDS OF MARICOPA COUNTY, ARIZONA.

AREA

CONTAINS 195,734 SQUARE FEET OR 4.49 ACRES MORE OR LESS.

BASIS OF BEARING

S89°46'20"E ALONG ROSE GARDEN LANE PER THE RECORDED PLAT OF "ROSE GARDEN CENTER" RECORDED IN BOOK 228 OF MAPS, PAGE 20, M.C.R.

BASIS OF SURVEY

COMMITMENT FOR TITLE INSURANCE ISSUED BY LAWYERS TITLE INSURANCE CORPORATION, FILE NO. 01388389, DATED AUGUST 30, 2004, 7:30 A.M.

SCHEDULE 'B' ITEMS

- ④ EASEMENT(S) FOR THE PURPOSE(S) SHOWN BELOW AND RIGHTS INCIDENTAL THERETO AS GRANTED IN A DOCUMENT
 PURPOSE: CABINETS AND ELECTRICAL LINES AND APPURTENANT FACILITIES
 RECORDED: JANUARY 29, 1981, DOCKET 14992, PAGE 14
 AFFECTS: AS DESCRIBED THEREIN
- ⑤ EASEMENT(S) FOR THE PURPOSE(S) SHOWN BELOW AND RIGHTS INCIDENTAL THERETO AS GRANTED IN A DOCUMENT
 PURPOSE: ELECTRIC LINES AND APPURTENANT FACILITIES
 RECORDED: AUGUST 20, 1982, DOCKET 16234, PAGE 763
 AFFECTS: AS DESCRIBED THEREIN
- ⑥ DECLARATION OF ACCESS EASEMENT RECORDED IN DOCUMENT NO. 04-609732.

CERTIFICATION

CERTIFIED TO: FIRST INDUSTRIAL ACQUISITIONS, INC., A MARYLAND CORPORATION; FIRST INDUSTRIAL DEVELOPMENT SERVICES, INC.; FIRST INDUSTRIAL L.P.; ACH, L.L.C. AND ARIZONA LIMITED LIABILITY COMPANY; FIDELITY NATIONAL TITLE INSURANCE COMPANY

THIS IS TO CERTIFY THAT THIS MAP OR PLAT AND THE SURVEY ON WHICH IT IS BASED WERE MADE IN ACCORDANCE WITH "MINIMUM STANDARD DETAIL REQUIREMENTS FOR ALTA/ACSM LAND TITLE SURVEYS" JOINTLY ESTABLISHED AND ADOPTED BY ALTA, ACSM AND NSPS IN 1999, AND INCLUDES ITEMS 1, 6, 8, 10, 11, 14, 15 AND 16 OF TABLE A THEREOF, PURSUANT TO THE ACCURACY STANDARDS AS ADOPTED BY ALTA, NSPS AND ACSM AND IN EFFECT ON THE DATE OF THIS CERTIFICATION, THE UNDERSIGNED FURTHER CERTIFIES THAT THE SURVEY MEASUREMENTS WERE MADE IN ACCORDANCE WITH THE "MINIMUM ANGLE, DISTANCE AND CLOSURE REQUIREMENTS FOR SURVEY MEASUREMENTS WHICH CONTROL LAND BOUNDARIES FOR ALTA/ACSM LAND TITLE SURVEYS."



Timothy M. O'Neill
 TIMOTHY M. O'NEILL, R.L.S. #17403
 DATE: 9/27/04

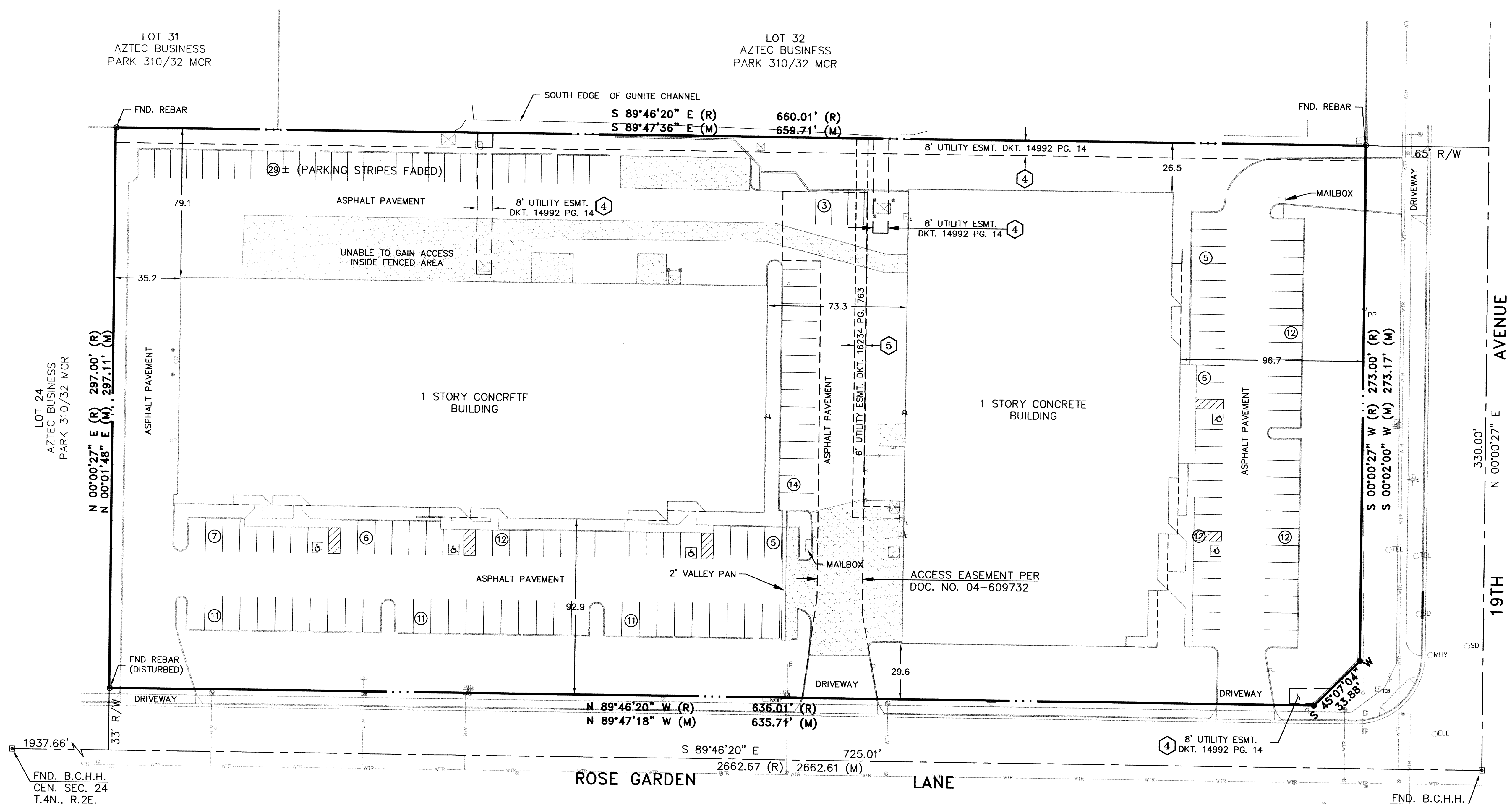

Revision Date	By
09-27-04	MGO

O'NEILL ENGINEERING, INC.
 2001 West Camelback Road
 Suite 200
 Phoenix, Arizona 85015
 (602) 242-0020 FAX: (602) 242-5722
 E-mail Address: drawings@oneilleng.com

ALTA/ACSM SURVEY

1ST INDUSTRIAL DEVELOPMENT SERVICES, INC.

21002 N. 19TH AVE.
 PHOENIX, AZ 85027

Design: TMO
 Drawn: RLF
 Scale: 1"=30'
 Sheet: 1

Date: SEPTEMBER, 2003 Job #: 3515 of 1