



City of Phoenix
PLANNING & DEVELOPMENT DEPARTMENT

Staff Report Z-49-13-8
February 28, 2014

Laveen Village Planning Committee Meeting Date March 10, 2014

Planning Commission Hearing Date April 8, 2014

Request From S-1 (Approved R1-10) (15.94 Acres)
County RU-43 (Pending S-1) (3.02 Acres)

Request To R1-8 (18.96 Acres)

Proposed Use Single-family residential subdivision

Location Approximately 1,000 feet south of the
southeast corner of 35th Avenue and Baseline
Road

Owner Partner Investments 2, LLC

Applicant/Representative Bill Lally, Tiffany and Bosco P.A.

Staff Recommendation Approval, subject to stipulations

General Plan Conformity			
General Plan Land Use Designation		Residential 2 - 3.5 du / acre	
Street Map Classification	35th Avenue	Arterial	33-foot half street
<p><i>LAND USE ELEMENT, GOAL 2, EMPLOYMENT AND POPULATION BALANCE: DEVELOPMENT OF EACH VILLAGE'S POTENTIAL SHOULD BE ENCOURAGED BY DISTRIBUTING A DIVERSITY OF EMPLOYMENT AND HOUSING IN A WAY THAT ACHIEVES A BALANCED CITYWIDE PLAN AND THAT IS CONSISTENT WITH COMMUTE TRAVEL PATTERNS AND THE CURRENT CHARACTER OF EACH DEVELOPED VILLAGE.</i></p> <p>This proposed project encourages new housing in the southwestern area of Phoenix.</p>			
<p><i>NEIGHBORHOOD ELEMENT, GOAL 1, NEW NEIGHBORHOOD DESIGN: ALL NEIGHBORHOODS SHOULD BE DESIGNED TO BE SAFE, WELL-MAINTAINED, PEDESTRIAN-ORIENTED, DESIRABLE PLACES TO LIVE.</i></p> <p>The proposed residential site plan encourages pedestrian circulation to promote neighborhood interaction through open space, pedestrian pathways and streets and convenient pedestrian access for residents to nearby amenities, including Cesar Chavez Park.</p> <p><i>NEIGHBORHOOD ELEMENT, GOAL 2, COMPATIBLE NEIGHBORHOOD DEVELOPMENT: NEW DEVELOPMENT AND EXPANSION OR REDEVELOPMENT OF EXISTING DEVELOPMENT IN OR NEAR RESIDENTIAL AREAS SHOULD BE COMPATIBLE WITH EXISTING USES AND CONSISTENT WITH ADOPTED PLANS.</i></p> <p>The proposed site plan is consistent with the surrounding single-family residential developments.</p>			

Surrounding Land Uses/Zoning		
	<u>Land Use</u>	<u>Zoning</u>
On Site	Vacant	S-1 (Approved R1-10), County RU-43 (Pending S-1)
North	Single Family Homes	S-1
South	Single Family Homes	R1-10
East	Single Family Homes	R1-18 PRD and S-1
West	Cesar Chavez Park	S-1

Single Family		*if variance required
<u>Standards</u>	<u>Requirements</u>	<u>Provisions on the Proposed site Plan</u>
Development Option	PRD	PRD
Gross Acreage	18.96	18.96
Total Number of Units	85	MET - 70
Density	4.5 du/ac	MET – 3.7 du/ac
Typical Lot Size	Varies	MET – 55' x 110'
Subject to Single Family Design Review	Yes	MET - Yes
Open Space	5%	MET – 12.3%

Background/Issues/Analysis

1. The purpose of the request is to rezone an 18.96-acre parcel from S-1 (Approved R1-10) and County RU-43 (Pending S-1) to R1-8 (18.96 acres) for a single-family residential subdivision. The property is located south of the southeast corner of 35th Avenue and Baseline Road.
2. The proposed zoning is not consistent with the current General Plan Land Use Map, which designates the parcel as Residential 2-3.5 du/acre. Because the request falls within the traditional lot option for the R1-8 zoning district a General Plan amendment is not required.
3. The majority of the subject parcel (16 acres) was annexed and rezoned in 2006 (Z-59-06-7) to R1-10 to allow for a single-family subdivision. The remaining three acres of the



subject property is located in the County and is currently in the annexation process to incorporate into the City of Phoenix.

4. A single-family residential development zoned R1-10 is located to the south of the subject parcel. A large lot neighborhood, located in the County, is located to the north, east and west. A single-family subdivision zoned R1-18 is also located to the east. The parcel is located in close proximity to Cesar Chavez Park located to the west across 35th Avenue.
5. Adopted in 1998, the Laveen Southwest Growth Study provides guidance for land use decisions in the Laveen Village, including recommended design guidelines. The Growth Study Land Use Plan designates the site as Residential 2-5 dwelling units per acre; the proposed density is consistent with the Plan designation. The Growth Study identifies several design guidelines including the use of view-fencing for all perimeter walls; the use of view-fencing along the site's perimeter is not appropriate as the site is adjacent, or in close proximity, to active agricultural uses, non-domesticated animal keeping, open wells, a city park, and industrial activities.

The Study also recommends that perimeter walls be constructed of varying materials to avoid a "blank face" appearance; a stipulation is recommended that requires the use of certain materials as well as a decorative wall cap.

6. The conceptual site plan shows a single-family subdivision consisting of 70 lots. Staff is recommending a series of stipulations that address open space, number of lots, pedestrian walkways and perimeter walls.

Open Space

The residential site plan shows multiple landscape, open space and retention tracts provided throughout the development. Staff is recommending a minimum of 12% open space be provided throughout the development to ensure the amenities and grassy areas depicted are constructed.

Site Plan

The conceptual residential site plan shows 70 lots with an average size of 55 feet wide by 110 feet deep.

The maximum number of dwelling units allowed for this proposed development is 85. Staff is recommending limiting the maximum number of units that may be constructed to 70. This will allow for an appropriate transition between the single-family neighborhood to the south and east and the existing larger lot homes located in the County.

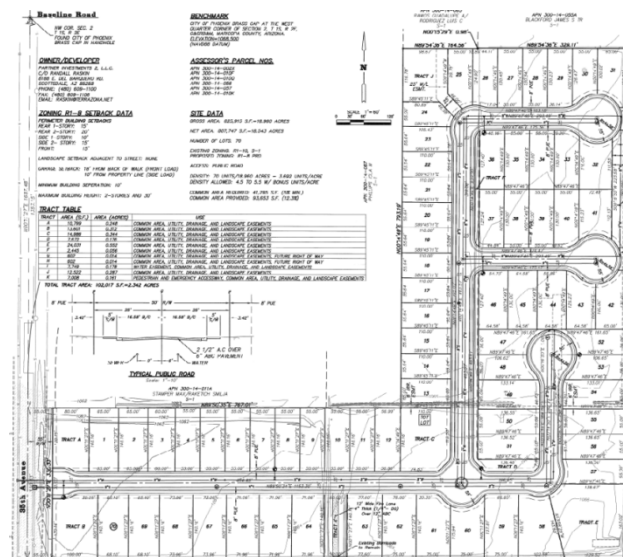

In addition the site plan shown is conceptual in nature and elevations are not provided. Staff is recommending a stipulation for Planning Hearing Officer review of the conceptual site plan and elevations through the public hearing process. This will ensure compatibility with the adjacent residential subdivisions.

Traffic

The conceptual site plan shows vehicular access via 35th Avenue. The streets within the subdivision will be public and a traffic circle is shown at the southeast portion of the development.

Staff is recommending that 34th Avenue be constructed and connect the subject single-family neighborhood to the existing subdivision located to the south. This will allow pedestrian and vehicular traffic to flow freely between adjacent residential developments.

Screening

Staff is recommending that the development's landscape tracts/open space C, E, J and I be constructed using view fencing for abutting lots 12, 13, 24, 25, 32, 41, 57 and 58. This will ensure that the landscape tracts/open space will be viewable to the adjacent and area residents.

6. This proposed development is subject to Single-Family Design Review Guidelines. The review guidelines are to provide house designs with sufficient variation in elevations and detailing which address the goal of diversity while maintaining an identifiable image for the subdivision. Review of the elevations includes materials, massing, front yard plant palette, garage treatments, and safety.
7. Development and use of the site is subject to all applicable codes and ordinances. Zoning approval does not negate other ordinance requirements. Other formal actions such as, but not limited to, zoning adjustments and abandonment may be required.

Findings

1. The proposed use is consistent with the designation of Residential 2-3.5 du/ac on the General Plan Land Use Map.
2. The proposed development will provide additional housing choices for the Laveen Village residents that are compatible with existing developments.
3. The proposed residential development provides appropriate common open space and amenities.

Stipulations

1. The conceptual elevations or site plan shall be administratively approved by the Planning Hearing Officer prior to preliminary site plan approval. This review is for conceptual purposes only. Specific development standards and requirements will be determined by the Planning and Development Department.
2. The maximum number of residential lots shall not exceed 70 lots, as approved by the Planning and Development Department.
3. The development shall have a minimum of 12% open space, as approved by the Planning and Development Department.
4. Lots 12, 13, 24, 25, 32, 41, 57 and 58 shall construct perimeter walls with minimum 3 feet of view fencing for the shared property lines with landscape tract/open space C, E, J and I, as approved by the Planning and Development Department.
5. The exterior of the perimeter walls shall be, or finished with, stucco, decorative concrete, brick, or stone. The top tier of all perimeter walls shall be finished with some form of enhancement or embellishment, such as but not limited to corbels, cornices, dentils, pilasters, or artistic insets, which contrasts with the primary wall material as approved by the Planning and Development Department.
6. Sidewalks shall be provided on both sides of all streets and shall be detached from the street a minimum of five feet, as approved by the Planning and Development Department.
7. The property owner shall record documents that disclose the existence, and operational characteristics of Sky Harbor International Airport to future owners or tenants of the property. The form and content of such documents shall be according to the templates and instructions provided, which have been reviewed and approved by the City Attorney.
8. The applicant shall dedicate and construct 34th Avenue and connect to the proposed subdivision, as approved by the Planning and Development Department.
9. The applicant shall dedicate a total of 55 feet for the east half of 35th Avenue with a 30-foot Multi-Use Trail Easement (MUTE), as approved by the Planning and Development Department.

Staff Report: Z-49-13-8

February 28, 2014

Page 6 of 6

10. The developer shall construct all streets within and adjacent to the development with paving, curb, gutter, sidewalk, curb ramps, streetlights, landscaping and other incidentals as per plans approved by the Planning and Development Department. All improvements shall comply with all ADA accessibility standards.

Writer

Marc Thornton

2/21/14

Attachments

Zoning Sketch

Aerial

Site Plan date stamped February 13, 2014

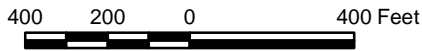
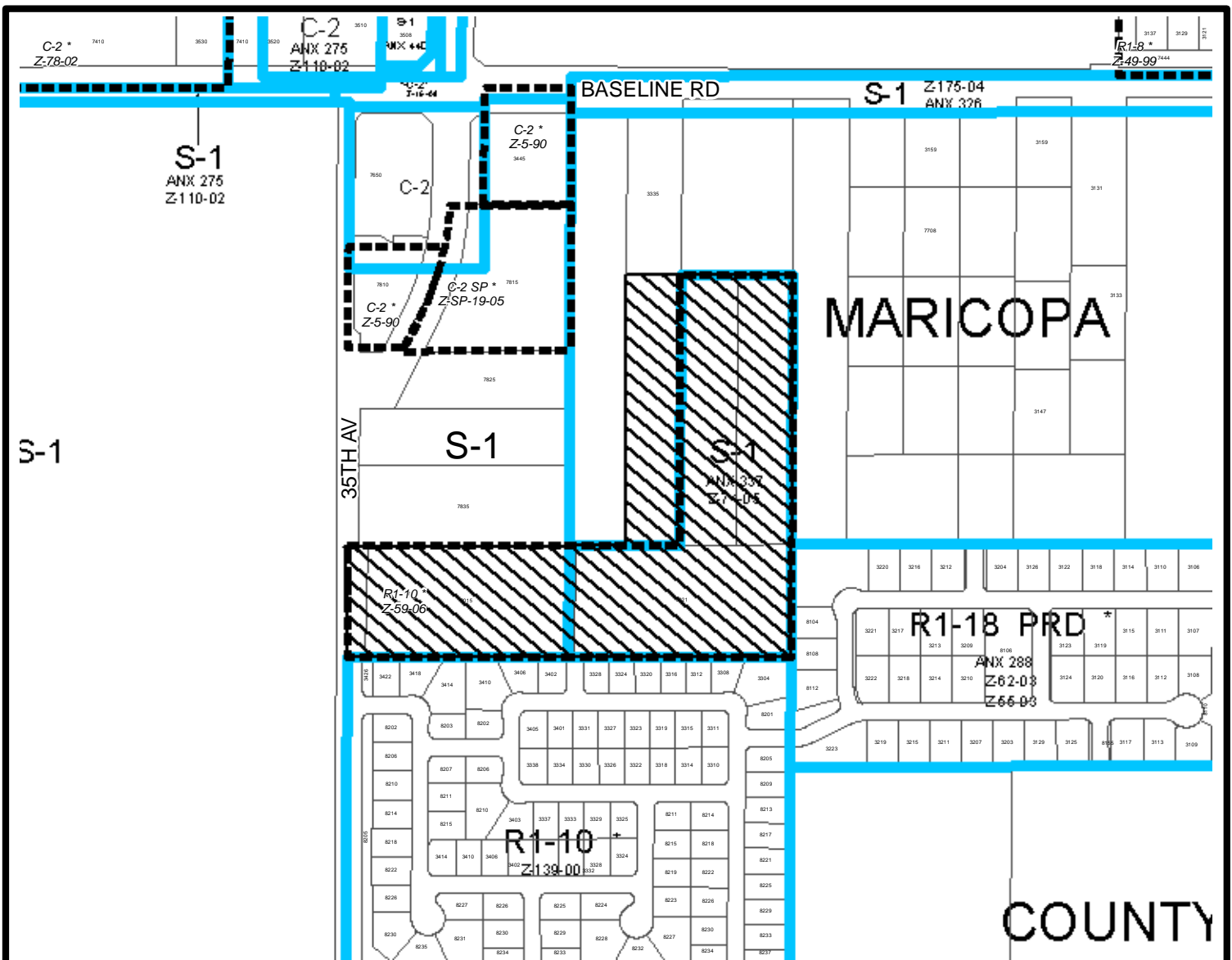

CITY OF PHOENIX PLANNING DEPARTMENT

LAVEEN VILLAGE

CITY COUNCIL DISTRICT: 8

Z-49-13

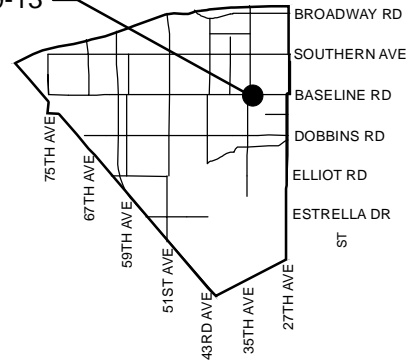

APPLICANT'S NAME: Randall Raskin		REQUESTED CHANGE: FROM: S-1 (Approved R1-10), (15.94 a. c.) County RU-43 (Pending S-1), (3.02 a. c.) TO: R1-8, (18.96 a. c.)	
APPLICATION NO. Z-49-13	DATE: 11/6/13 REVISION DATES:		
<small>GROSS AREA INCLUDING 1/2 STREET AND ALLEY DEDICATION IS APPROX.</small> 18.96 Acres	<small>AERIAL PHOTO & QUARTER SEC. NO.</small> QS 01-21	<small>ZONING MAP</small> D-6	
MULTIPLES PERMITTED S-1, Approved R1-10, Pending S-1 R1-8	CONVENTIONAL OPTION 16, 48, 3 76	* UNITS P.R.D. OPTION 16, 67, 3 98	

* Maximum Units Allowed with P.R.D. Bonus



W Baseline Rd

W Baseline Rd

W Baseline Rd

S 35th Ave

S 35th Ave

S 33rd Ave

Cesar Chavez Park

S 35th Ave

Subject Parcel

S 32nd Dr

W Melody Dr

S 32nd Ln

S 31st Ln

W Ian Dr

W Ian Dr

W Desert Ln

W Desert Ln

Baseline Road

NW COR. SEC. 2
T 1S, R 2E
FOUND CITY OF PHOENIX
BRASS CAP IN HANDHOLE

OWNER/DEVELOPER

PARTNER INVESTMENTS 2, L.L.C.
C/O RANDALL RASKIN
8188 E. DEL BARQUERO RD.
SCOTTSDALE, AZ 85258
PHONE: (480) 609-1100
FAX: (480) 609-1106
EMAIL: RASKIN@TERRAZONA.NET

ZONING R1-8 SETBACK DATA

PERIMETER BUILDING SETBACKS

REAR 1-STORY: 15'
REAR 2-STORY: 20'
SIDE 1-STORY: 10'
SIDE 2-STORY: 15'
FRONT: 15'

LANDSCAPE SETBACK ADJACENT TO STREET: NONE

GARAGE SETBACK: 18' FROM BACK OF WALK (FRONT LOAD)
10' FROM PROPERTY LINE (SIDE LOAD)

MINIMUM BUILDING SEPERATION: 10'

MAXIMUM BUILDING HEIGHT: 2-STORIES AND 30'

TRACT TABLE

TRACT	AREA (S.F.)	AREA (ACRES)	USE
A	10,799	0.248	COMMON AREA, UTILITY, DRAINAGE, AND LANDSCAPE EASEMENTS
B	13,601	0.312	COMMON AREA, UTILITY, DRAINAGE, AND LANDSCAPE EASEMENTS
C	14,986	0.344	COMMON AREA, UTILITY, DRAINAGE, AND LANDSCAPE EASEMENTS
D	7,672	0.176	COMMON AREA, UTILITY, DRAINAGE, AND LANDSCAPE EASEMENTS
E	24,031	0.552	COMMON AREA, UTILITY, DRAINAGE, AND LANDSCAPE EASEMENTS
F	2,445	0.056	COMMON AREA, UTILITY, DRAINAGE, AND LANDSCAPE EASEMENTS
G	602	0.014	COMMON AREA, UTILITY, DRAINAGE, AND LANDSCAPE EASEMENTS, FUTURE RIGHT OF WAY
H	602	0.014	COMMON AREA, UTILITY, DRAINAGE, AND LANDSCAPE EASEMENTS, FUTURE RIGHT OF WAY
I	7,749	0.178	WATER EASEMENT, COMMON AREA, UTILITY, DRAINAGE, AND LANDSCAPE EASEMENTS
J	12,522	0.287	COMMON AREA, UTILITY, DRAINAGE, AND LANDSCAPE EASEMENTS
K	7,008	0.161	PEDESTRIAN AND EMERGENCY ACCESSWAY, COMMON AREA, UTILITY, DRAINAGE, AND LANDSCAPE EASEMENTS

TOTAL TRACT AREA: 102,017 S.F.=2.342 ACRES

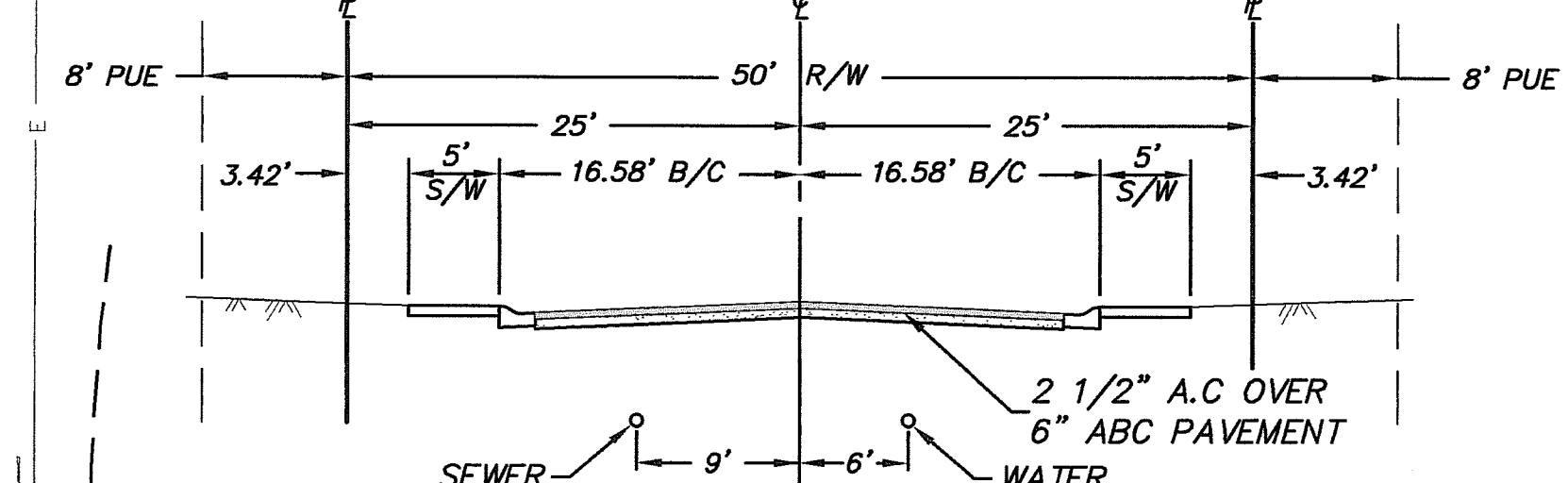

TYPICAL PUBLIC ROAD

Scale: 1"=10'

APN 300-14-011A
STAMPER MAX/RAKETCH SMILJA
S-1

N89°50'35"E 767.01'

SIERRA VISTA
PER BOOK 599 OF MAPS, PAGE 13, MCR
R1-10

BENCHMARK

CITY OF PHOENIX BRASS CAP AT THE WEST QUARTER CORNER OF SECTION 2, T 1S, R 2E, G&SRB&M, MARICOPA COUNTY, ARIZONA. ELEVATION=1068.500 (NAVD88 DATUM)

ASSESSOR'S PARCEL NOS.

APN 300-14-002X
APN 300-14-010F
APN 300-14-010Q
APN 300-14-056
APN 300-14-057
APN 300-14-010K

SITE DATA

GROSS AREA: 825,915 S.F.=18.960 ACRES

NET AREA: 807,747 S.F.=18.543 ACRES

NUMBER OF LOTS: 70

EXISTING ZONING: R1-10, S-1
PROPOSED ZONING: R1-8 PRD

ACCESS: PUBLIC ROAD

DENSITY: 70 UNITS/18.960 ACRES = 3.692 UNITS/ACRE
DENSITY ALLOWED: 4.5 TO 5.5 W/ BONUS UNITS/ACRE

COMMON AREA REQUIRED: 41,295 S.F. (5% MIN.)
COMMON AREA PROVIDED: 93,653 S.F. (12.3%)

APN 300-14-067
PHILLIPS IOLA M
S-1

APN 300-14-065
RAMOS GUADALUPE A/
RODRIGUEZ LUIS C
S-1
N00°15'29"E 0.98'

APN 300-14-055A
BLACKFORD JAMES S TR
S-1
N89°54'36"E 164.56'

APN 300-14-055A
BLACKFORD JAMES S TR
S-1
N89°54'36"E 329.11'

CITY OF PHOENIX

FEB 18 2014

Planning & Development
Department

SITE PLAN

FOR

LAVEEN MEADOWS

AN R1-8 PRD SUBDIVISION SITUATED IN PORTION OF THE NORTHWEST QUARTER OF SECTION 2, TOWNSHIP 1 SOUTH, RANGE 2 EAST OF THE GILA AND SALT RIVER BASE AND MERIDIAN, MARICOPA COUNTY, ARIZONA

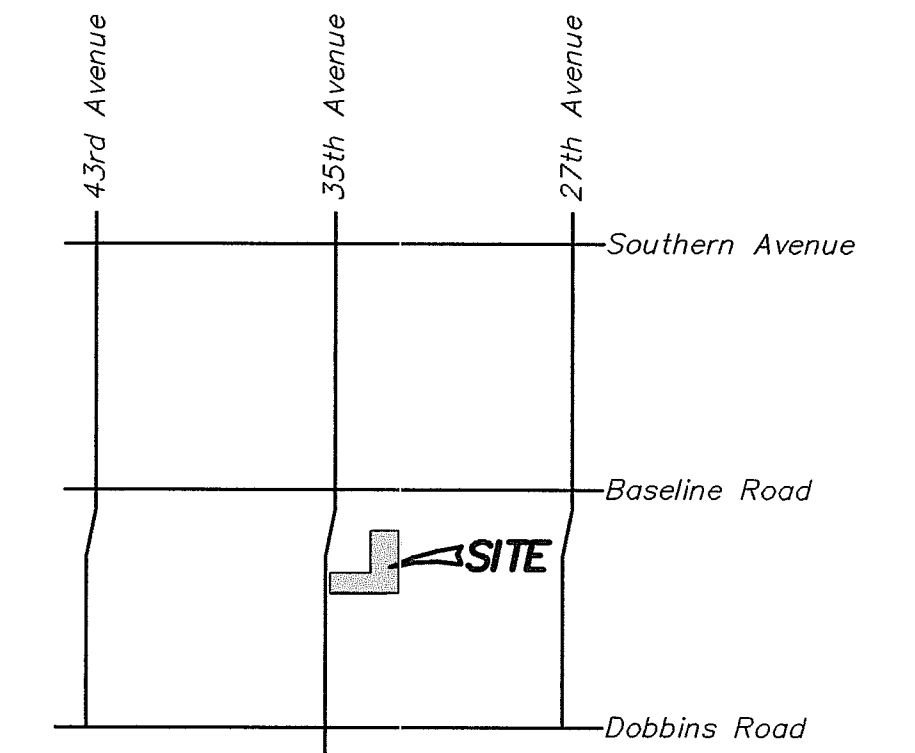

VICINITY MAP

Not to Scale

LEGAL DESCRIPTION

A PORTION OF LOTS 4 AND 5, YOUNG ACRES ACCORDING TO THE PLAT OF RECORD IN BOOK 17 OF MAPS, PAGE 15, RECORDS OF MARICOPA COUNTY, ARIZONA AND A PORTION OF THE NORTHWEST QUARTER OF SECTION 2, TOWNSHIP 1 SOUTH, RANGE 2 EAST OF THE GILA AND SALT RIVER BASE AND MERIDIAN, MARICOPA COUNTY, ARIZONA MORE PARTICULARLY DESCRIBED AS FOLLOWS:

BEGINNING AT THE NORTHWEST CORNER OF SAID SECTION 2, THENCE SOUTH 0°11'27" WEST ALONG THE WEST LINE OF SAID SECTION 2, A DISTANCE OF 1357.15 FEET TO THE TRUE POINT OF BEGINNING OF THE HEREIN DESCRIBED PARCEL; THENCE NORTH 89°50'35" EAST, A DISTANCE OF 822.01 FEET; THENCE NORTH 0°14'49" EAST, A DISTANCE OF 793.19 FEET; THENCE NORTH 89°54'36" EAST, A DISTANCE OF 164.56 FEET; THENCE NORTH 0°15'29" EAST, A DISTANCE OF 0.98 FEET; THENCE NORTH 89°54'36" EAST, A DISTANCE OF 329.11 FEET; THENCE SOUTH 0°16'50" WEST, A DISTANCE OF 1123.92 FEET; THENCE SOUTH 89°50'34" WEST, A DISTANCE OF 1314.69 FEET; THENCE NORTH 0°11'27" EAST, A DISTANCE OF 330.33 FEET TO THE TRUE POINT OF BEGINNING.

PROJECT DESCRIPTION & STATEMENT OF INTENT

PARTNER INVESTMENTS 2, LLC IS PROPOSING A NEW SINGLE FAMILY RESIDENTIAL DEVELOPMENT LOCATED AT APPROXIMATELY 1360 FEET SOUTH OF BASELINE ROAD AND EAST OF 35TH AVENUE. THE PROPOSED RESIDENTIAL DEVELOPMENT IS KNOWN AS 'LAVEEN MEADOWS'.

THE SITE INCLUDES 75 SINGLE FAMILY RESIDENTIAL LOTS WITH AMPLE OPEN SPACE AREAS AND TRACTS FOR LANDSCAPING AND COMMON AREAS. THE LOTS HAVE AN AVERAGE LOT SIZE OF 7000 SQUARE FEET. THE PROPOSED DENSITY OF THE SITE IS 3.95 UNITS PER ACRE. THE EXISTING ZONING ON THE SITE IS S-1 AND R1-10. THE PROPOSED ZONING IS R1-8.

THE SITE WILL HAVE PUBLIC ROADS OF 50 FOOT RIGHT OF WAY AND PUBLIC CITY MAINTAINED WATER AND SEWER LINES. A WATER METER AND SEWER TAP WILL BE PROVIDED TO EACH LOT.

DRAINAGE STATEMENT

-NO OFFSITE FLOWS AFFECT THIS SITE.

-SITE LIES IN ZONE 'X'

-100 YEAR 2 HOUR COMMON RETENTION WILL BE PROVIDED IN THE TRACTS.

-ALL FLOORS WILL BE SET 14" MINIMUM ABOVE LOW TOP OF CURB AND FREE FROM INUNDATION FROM 100-YEAR STORM EVENT.

LEGEND

- APN ASSESSOR'S PARCEL NUMBER
- MCR MARICOPA COUNTY RECORDER
- R/W RIGHT OF WAY
- W/L WATERLINE
- ⊙ SURVEY MONUMENT (AS NOTED)
- PROPERTY BOUNDARY CORNER
- PROPERTY LINE
- - - EASEMENT LINE
- STREET CENTERLINE
- ▨ ADJACENT LOT OR R/W
- ▨ EXISTING PAVEMENT HATCH
- ⊕ FIRE HYDRANT

SHEET 1 OF 1

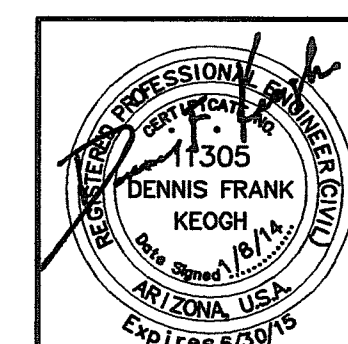

PREPARED FOR
Partners Investments 2, LLC

SITE PLAN
FOR
LAVEEN MEADOWS
AN R1-8 PRD SUBDIVISION SITUATED IN PORTION OF THE NORTHWEST QUARTER OF SECTION 2, TOWNSHIP 1 SOUTH, RANGE 2 EAST OF THE GILA AND SALT RIVER BASE AND MERIDIAN, MARICOPA COUNTY, ARIZONA

Keogh Engineering, Inc.
14150 W. McDOWELL ROAD • GOODYEAR, ARIZONA 85395
PHONE: (623) 535-7260 FAX: (623) 535-7262
EMAIL: keogh@keogheengineering.com

DRAWN BY SPK
CHECKED BY DFK
FIELD WORK BY GJ
DATE JANUARY, 2014 JOB NO. 19651 MAP NO. P-19651

AutoCad Version: 16.0
Login Name: SHAUNKEOGH
Plot Date / Time: 01/08/14 10:39am
Full File Path: L:\19651\Site Plan\SP-1.dwg
Layout Name: Sheet 1
Sheet 1